

PT-SPC1-15P1

1-1/2 HP IRRIGATION PUMP

- Cast Iron Construction
- 115/230 Dual Voltage
- 2 in. Suction, 1-1/2 in. Discharge
- 1-Year Warranty

Performance at 10 ft. Lift

Discharge Pressure (PSI)	15	20	30	40 (45 max)
GPM	64	61	52	28





PRO-TRADE™ Features & benefits



PUMP



- 2" Suction and 1.5" Discharge - (same or better than other popular brands)
- Robust Cast Iron Pump Case - (100 psi)
- Precision Injection Molded Impeller (self manufactured for performance and durability)
- Easy-access drain plug
- 100% Factory Tested - (pump & motor)
- Superior Pressure & Flow Performance (gpm, psi, amps, volts, rotation, in & out of start windings)
- Silicon Carbide Rotary Seal - (Best in the industry)
- 416 SS Threaded shaft (self manufactured)

Impeller



Silicon carbide faces should be used in any environment where a ceramic/carbon combination would not be suitable (ie any high-abrasive, high abuse or continuous run environment.) Last, the corrosion-resistance of silicon carbide is better.



Rotary Seal



PRO-TRADE™ Features & benefits



MOTOR

WE ARE THE ONLY PUMP COMPANY IN NORTH AMERICA THAT MANUFACTURES ITS OWN CENTRIFUGAL MOTORS

- Zinc Clad Motor Shell - (inhibits corrosion)
- Varnish Dipped Stator Windings - (seals out moisture and reduces vibration) (Hi-potted three times at 2300v)
- Individually Balanced Rotors - (100% to assure smooth, quiet, long life)
- Self-Lubricating SS Ball Bearings - (two, oversized front and rear bearings)
- Superior Cooling Fan - (self manufactured)
- Directional Air-Flow Cooling - (hi-flow air movement through motor housing. Protects switch, governor and capacitor).
- Sealed Switch Assembly - (protection against dust and debris)
- Hi-Service Factor Motor - (1.5 hp motor has a 1.3 SF) ($1.5 \times 1.3 = 1.95$ hp)
- Dual Voltage Motor - (115V or 230V) (FACTORY SET at 230V)

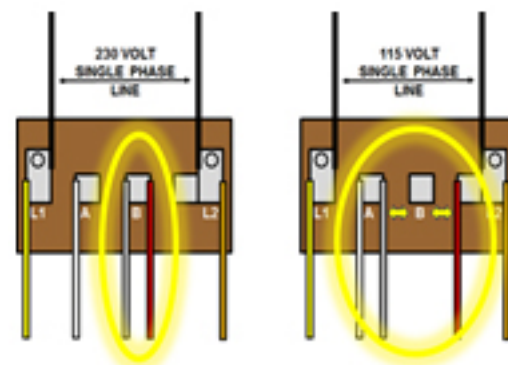
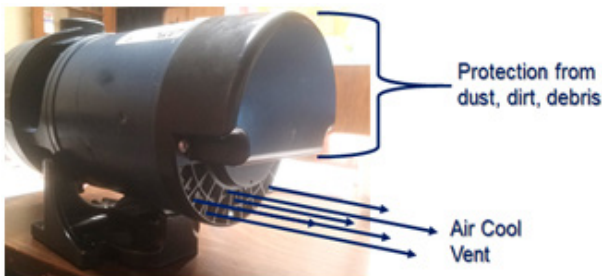
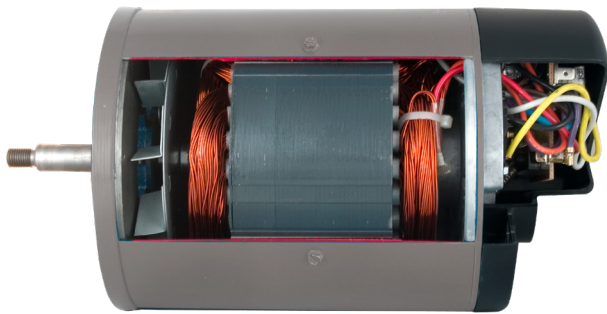

PRO-TRADE™ Performance

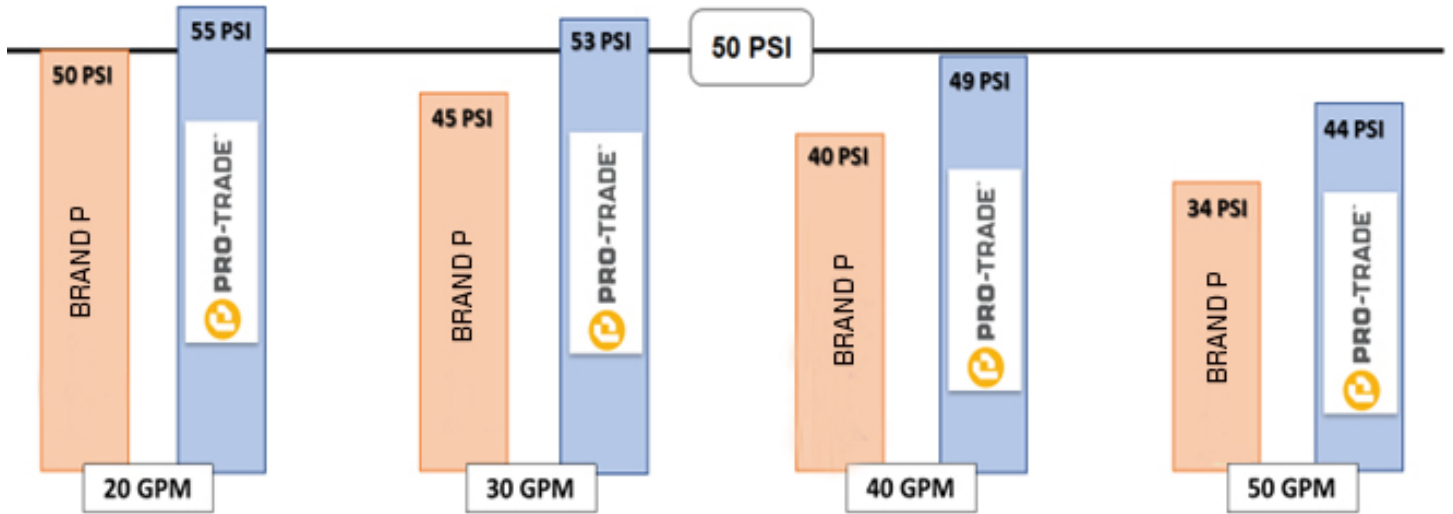

*Performance based on CSA Approved Lab Audit Test



PRO-TRADE™ Comparisons



	 PRO-TRADE™	BRAND P	BRAND G
Rotary Shaft Seal	Silicon / Carbide	Ceramic / Carbide	Ceramic / Carbide
Suction Size	2"	2"	1.5"
Discharge	1.5"	1.5"	1.5"
Manufacture Motor	YES	NO	NO
100% Factory Tested (Electrical & Hydraulics)	YES	NO	NO

 PRO-TRADE™		OTHERS
Yes	65° Ambient Motor Temperature Rise	No
Yes	100 PSI Maximum Case Pressure	No
Yes	Silicon Carbide Shaft Seal	No
Yes	NEMA J 56 Frame Motor	No
Yes	Made in the USA	No









PRO-TRADE™ Troubleshooting



Problem	Possible Cause	Corrective Action
A. Little or no discharge	<ol style="list-style-type: none"> 1. Casing not initially filled with water 2. Vertical lift too high or too long 3. Hole or air leak in inlet line 4. Foot valve too small 5. Foot valve or inlet line not submerged deep enough in water 6. Motor wired incorrectly 7. Inlet or outlet line valves closed 	<ol style="list-style-type: none"> 1. Fill pump casing 2. Move pump closer to water source 3. Repair or replace inlet line. Use thread tape and pipe sealing compound 4. Match foot valve to piping or install one size larger foot valve. 5. Submerge foot valve lower in water 6. Check wiring diagram 7. Open valves
B. Pump will not deliver water or develop pressure	<ol style="list-style-type: none"> 1. No priming water in casing 2. Leak in inlet line 3. Outlet line is closed and priming air has nowhere to go 4. Inlet line (or valve) is closed 5. Foot valve is leaking 6. Inlet screen clogged 	<ol style="list-style-type: none"> 1. Fill pump casing 2. Repair or replace 3. Open ball valve 4. Open line or valve 5. Replace foot valve 6. Clean or replace inlet screen
C. Loss of suction	<ol style="list-style-type: none"> 1. Hole or air leak in inlet line 2. Vertical lift too high 3. Insufficient inlet pressure or suction head 4. Clogged foot valve or strainer 	<ol style="list-style-type: none"> 1. Repair or replace inlet line. Use thread tape and pipe sealing compound 2. Reduce vertical lift, install foot valve and prime 3. Increase inlet pressure by adding more water to tank or increasing back pressure 4. Inspect foot valve and/or strainer for debris and remove
D. Pump vibrates and/or makes excessive noise	<ol style="list-style-type: none"> 1. Mounting plate or foundation not rigid enough 2. Foreign material in pump 3. Impeller damaged 	<ol style="list-style-type: none"> 1. Reinforce plate or foundation 2. Disassemble pump and clean 3. Replace impeller
E. Pump will not start or run	<ol style="list-style-type: none"> 1. Motor wired incorrectly 2. Blown fuse or open circuit breaker 3. Loose or broken wiring 4. Stone or foreign object lodged in impeller 5. Motor overheated 	<ol style="list-style-type: none"> 1. Check wiring diagram 2. Replace fuse or close circuit breaker 3. Tighten connections and replace broken wiring 4. Disassemble pump and remove foreign object 5. Allow unit to cool, restart after cooling
F. Pump loses prime	<ol style="list-style-type: none"> 1. Clogged foot valve or strainer 2. Worn or broken foot valve 3. Hole or air leak in inlet line 	<ol style="list-style-type: none"> 1. Inspect foot valve and/or strainer for debris, and remove. 2. Inspect and replace 3. Repair or replace inlet line. Use thread tape and pipe sealing compound



PRO-TRADE™ Advantage

-  **Exceptional Value**
-  **Silicon carbide rotary seal**
-  **100% factory tested (hi-potted to 2300V)**
-  **Fully enclosed switch**
-  **Superior performance (flow & pressure)**
-  **Feature rich**
-  **Made in the USA**

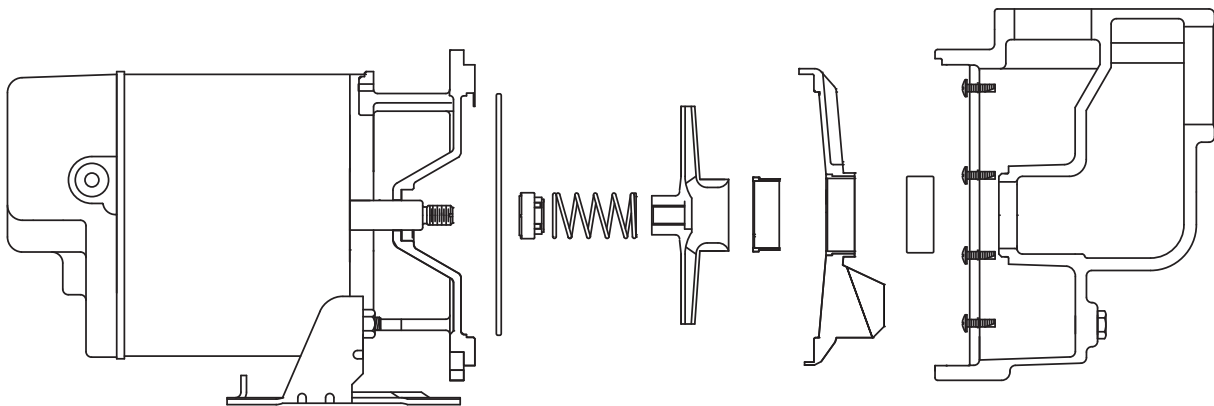

PT-SPC1-15P1

1-1/2 HP IRRIGATION PUMP

- Cast Iron Construction
- 115/230 Dual Voltage
- 2 in. Suction, 1-1/2 in. Discharge
- 1-Year Warranty

Performance at 10 ft. Lift

Discharge Pressure (PSI)	15	20	30	40 (45 max)
GPM	64	61	52	28

