



**NEW!**

**Papyrus™**

*See page 30*



**BELGARD**  
PAVES THE WAY™

## RESOURCE GUIDE

GREAT LAKES | MI, IN, OH,  
KY-LOUISVILLE, WESTERN PA

## LIFETIME TRANSFERABLE LIMITED WARRANTY

---

Oldcastle® APG, Inc. ("Belgard") is proud to inform you that all of our interlocking concrete paver and retaining walls ("Products") meet and/or exceed the requirements of ASTM C-936 and ASTM C-1372. Belgard® guarantees its Products against these standards for the lifetime of the Product defined by CMHA. This guarantee does not apply to splitting, chipping or other breakage that could be caused by impact, abrasion or overloading. This warranty is transferable. The original proof of purchase is required.

This warranty is only valid if the material is installed under the guidelines of CMHA ([masonryandhardscapes.org](http://masonryandhardscapes.org)) or the Belgard Installation Guideline Manual. Improper installation voids this warranty. This warranty is for residential applications only and does not apply to commercial applications. It is recommended that the job be installed by a Belgard Authorized Contractor participant who guarantees their workmanship for a minimum of 3 years from the date of install. For warranty service, contact Belgard at 877-BELGARD. A service representative will investigate your claim within 10 business days. If the Belgard product fails to meet the specifications, Belgard will replace the defective product at no charge. Color matching cannot be guaranteed. Belgard will not be responsible for any replacement labor, consequential damages or incidental damages. This warranty gives you specific legal rights, and you may also have other rights which vary from state to state. Some states do not allow for the exclusion or limitation of incidental or consequential damages, so the above limitation or exclusion may not apply to you.

For specific information regarding warranty coverage and exclusions in regards to the Elements™ and Porcelain Paver products, please visit: [Belgard.com/Warranty](http://Belgard.com/Warranty).

# ABOUT US

At Belgard®, we take our role as industry leaders seriously. Our rigorous research and development program is centred on innovation and quality. We never take it for granted that our products are the best in the business and constantly strive to improve and take the industry to the next level. Our overarching goal is to continue to find new and exciting ways to create beautiful outdoor spaces while maintaining incredibly high standards for product quality and performance.

Since 1995, our locally made and nationally backed products have transformed thousands of residential and commercial properties across North America. With more shapes, styles and textures than any other brand, Belgard's paving and wall products aren't just functional, they infuse outdoor spaces with distinctive atmosphere and style.

Every day, our network of Belgard Authorized Dealers and Contractors helps customers realize their outdoor dreams. And every year, we strive to improve our product and service offerings by dedicating more than 20,000 hours to research and development. By staying ahead of design trends, we are able to provide design-forward products that homeowners envision for their backyard spaces.

All of our outdoor products—when installed by a Belgard Authorized Contractor—are covered by a transferable lifetime limited warranty. That's just part of our commitment to lasting outdoor beauty.



# PAVERS & SLABS

## PAVERS & SLABS INSTALLATION GUIDE

4 Interlocking Concrete Pavement

### PAVERS & SLABS

5	Basalt™	28	Origins™
7	Belgian Cobble®	30	Papyrus™
9	Brooklyn™		
11	Cambridge Cobble®		
13	Charlestone™		
15	Dimensions™		
18	Dublin Cobble®		
22	Holland Stone		
24	Mega-Libre®		
26	Geometric Shapes		

For basic paver installation information  
visit [icpi.org](http://icpi.org)

# INTERLOCKING CONCRETE PAVEMENT (ICP)

**PATIO/WALK/RESIDENTIAL DRIVEWAY WITH PLASTIC EDGE RESTRAINT CROSS SECTION**

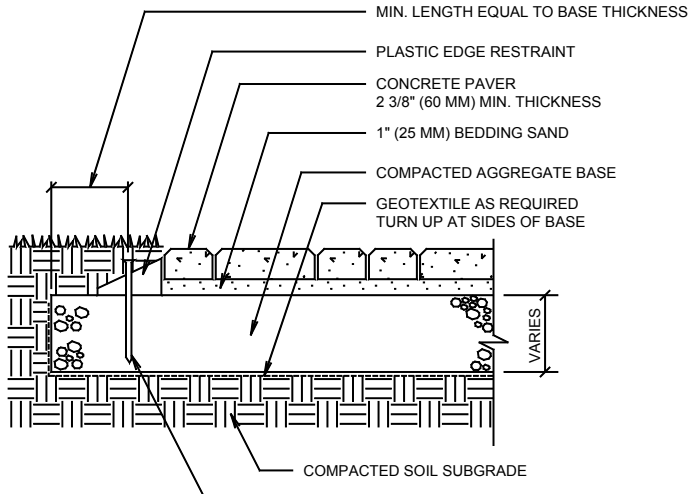

**RESIDENTIAL DRIVEWAY WITH CONCRETE EDGES CROSS SECTION**

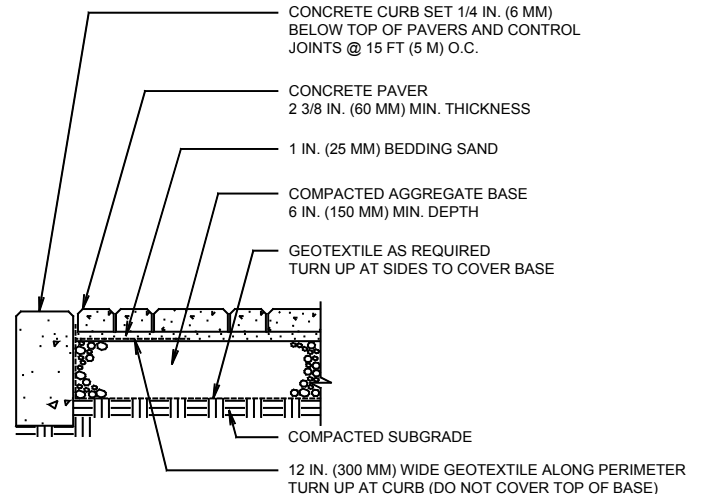

**PATIO/SIDEWALK ON COMPACTED AGGREGATE BASE CROSS SECTION**

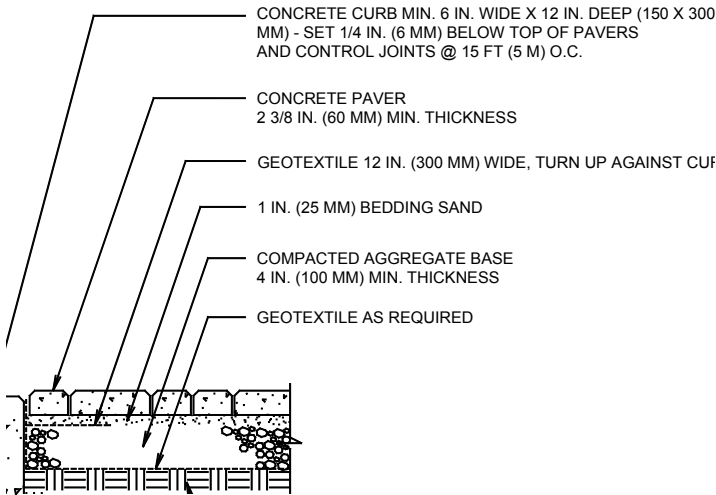

**SWIMMING POOL DECK AND COPING CROSS SECTION**

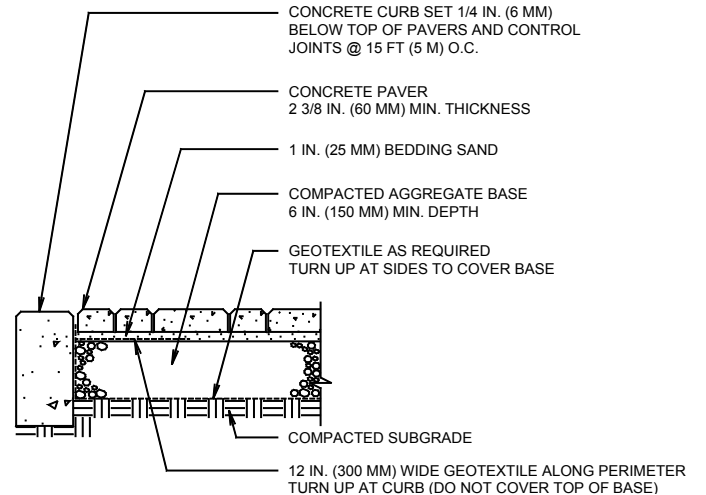





Scan for additional  
product information

PEDESTRIAN	LIGHT/REGULAR TRAFFIC	HEAVY TRAFFIC	PERMEABLE	ADA	DURAFUSION + COLORTECH
✓				✓	✓

## SHAPES & SIZES

### 3-Piece



6 x 12 x 2<sup>3</sup>/<sub>8</sub>

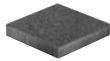

12 x 12 x 2<sup>3</sup>/<sub>8</sub>

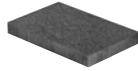

18 x 12 x 2<sup>3</sup>/<sub>8</sub>

UNIT	SQFT/ PALLET	SQFT/ LAYER	LAYER/ PALLET	UNITS/ PALLET	UNITS/ LAYER	UNITS/ SQFT	WEIGHT/ PALLET
<b>3-PIECE</b>							
6 X 12 X 2 <sup>3</sup> / <sub>8</sub>	–	–	10	–	–	–	–
12 X 12 X 2 <sup>3</sup> / <sub>8</sub>	–	–	10	–	–	–	–
18 X 12 X 2 <sup>3</sup> / <sub>8</sub>	–	–	10	–	–	–	–
<b>TOTAL</b>	<b>120</b>	<b>12</b>	<b>10</b>	<b>120</b>	<b>–</b>	<b>–</b>	<b>3516</b>

**NOTES:**

AutoCAD® hatch pattern files can be downloaded from [belgard.com](http://belgard.com) for use in architectural drawings.

Some patterns may not necessarily reflect the percentages of stone sizes within a particular pallet. In some cases you may have extras in one or more of the sizes. This must be accounted for in your planning and design.

Percentages are based on area by paver.

**3-PIECE PATTERN A**

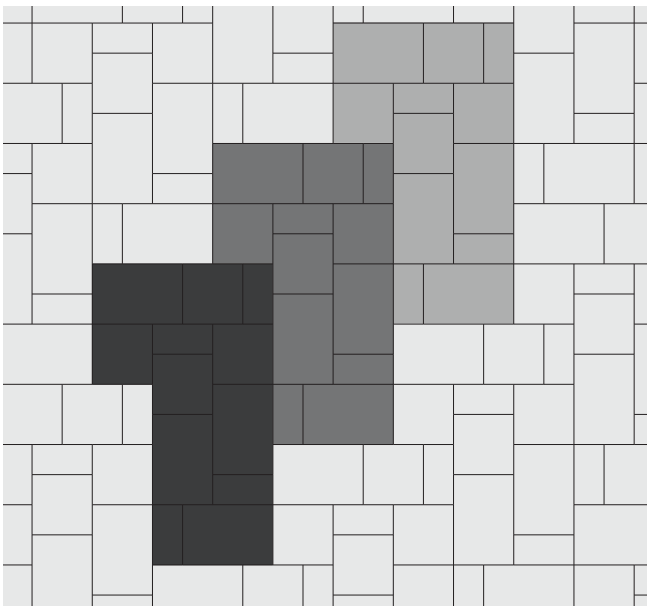

**3-PIECE PATTERN B**

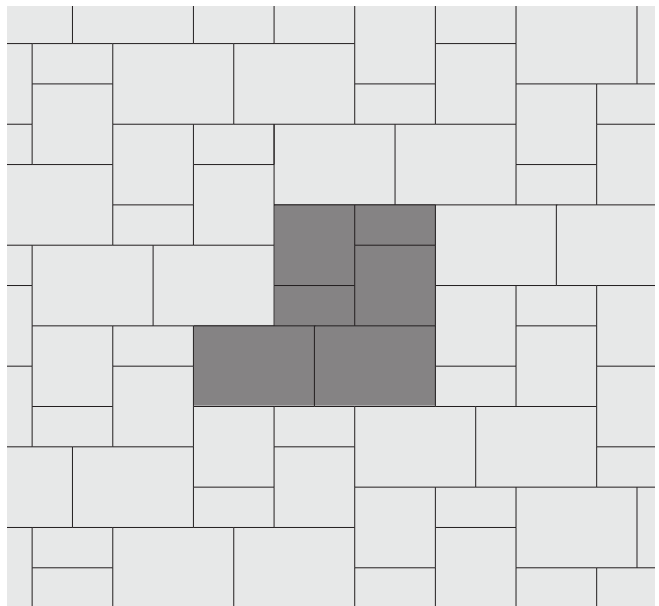

**3-PIECE HERRINGBONE PATTERN**

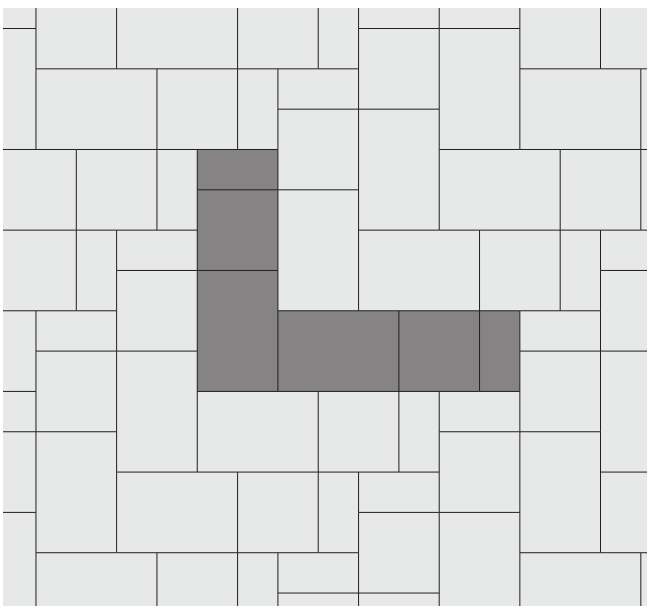



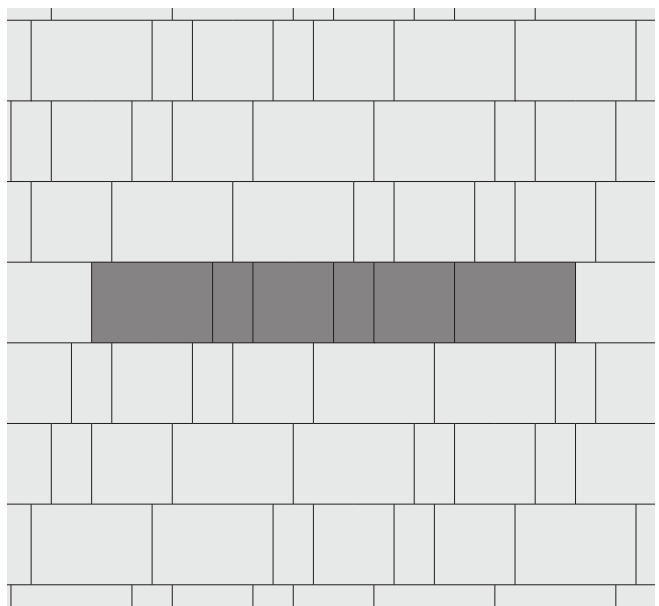

**3-PIECE RUNNING BOND PATTERN**







Scan for additional product information

PEDESTRIAN	LIGHT/REGULAR TRAFFIC	HEAVY TRAFFIC	PERMEABLE	ADA
				
✓	✓		✓	

## SHAPES & SIZES

### Multi-Piece



Variable x 2<sup>3/8</sup>

UNIT	SQFT/PALLET	SQFT/LAYER	LAYER/PALLET	UNITS/PALLET	UNITS/LAYER	UNITS/SQFT	WEIGHT/PALLET	LNFT/PALLET (SOLDIER)	LNFT/PALLET (SAILOR)
------	-------------	------------	--------------	--------------	-------------	------------	---------------	-----------------------	----------------------

### MULTI-PIECE

VARIABLE X 2 <sup>3/8</sup>	68	–	–	320	–	–	1640	–	–
-----------------------------	----	---	---	-----	---	---	------	---	---

Lay pavers at random.

**NOTES:**

AutoCAD® hatch pattern files can be downloaded from [belgard.com](http://belgard.com) for use in architectural drawings.

Some patterns may not necessarily reflect the percentages of stone sizes within a particular pallet. In some cases you may have extras in one or more of the sizes. This must be accounted for in your planning and design.

Percentages are based on area by paver.

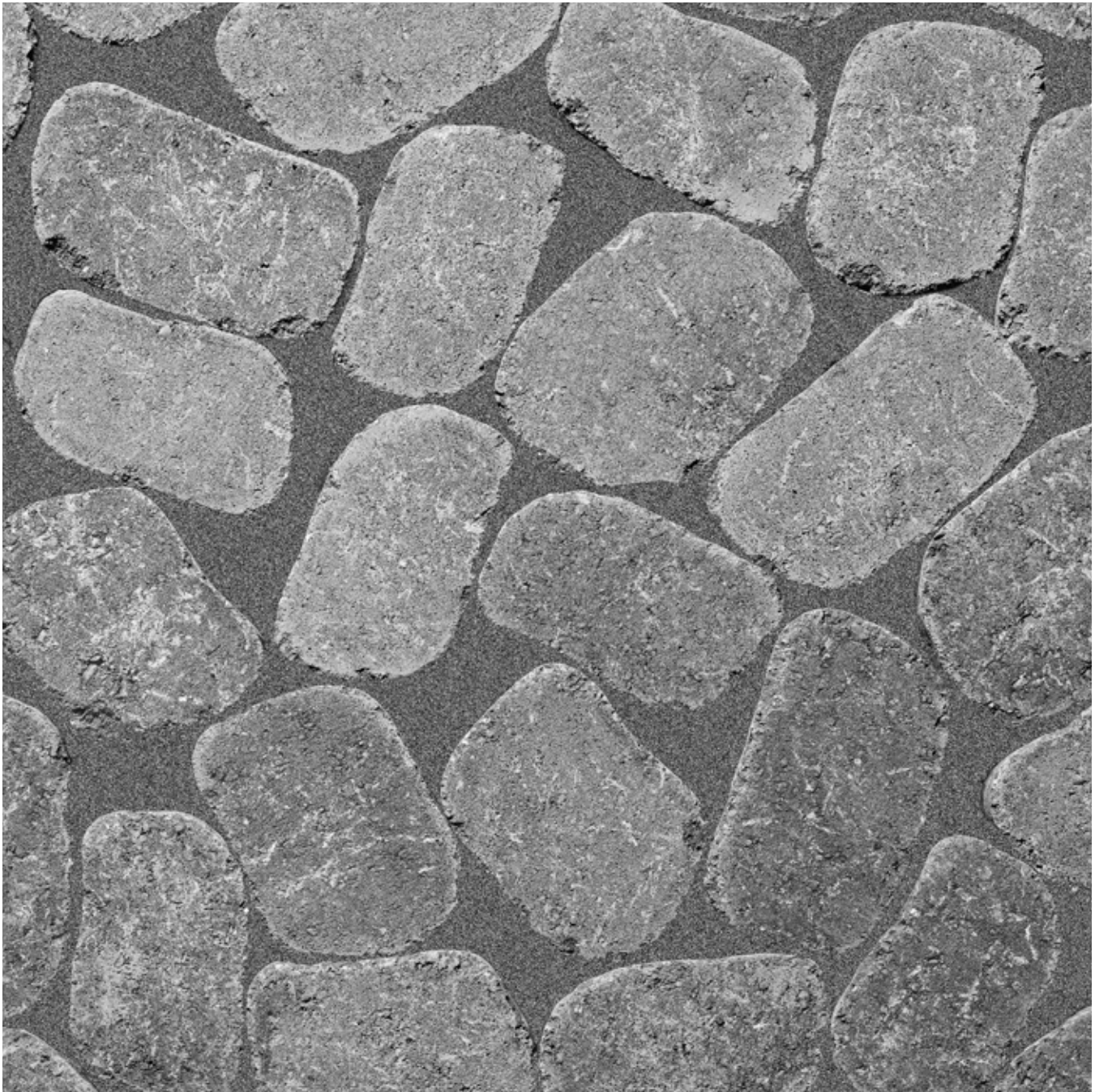





Scan for additional  
product information

PEDESTRIAN	LIGHT/REGULAR TRAFFIC	HEAVY TRAFFIC	PERMEABLE	ADA	DURAFUSION + COLORTECH
✓	✓			✓	✓

## SHAPES & SIZES

### 60mm



3 x 9 x 2<sup>3</sup>/<sub>8</sub>

UNIT	SQFT/ PALLET	SQFT/ LAYER	LAYER/ PALLET	UNITS/ PALLET	UNITS/ LAYER	SQFT/ UNIT	WEIGHT/ PALLET	LNFT/PALLET (SOLDIER)	LNFT/PALLET (SAILOR)
<b>60MM</b>									
<b>3 X 9 X 2<sup>3</sup>/<sub>8</sub></b>	103.13	10.3	10	550	55	.188	2805	137.5	412.5

**NOTES:**

AutoCAD® hatch pattern files can be downloaded from belgard.com for use in architectural drawings.

Some patterns may not necessarily reflect the percentages of stone sizes within a particular pallet. In some cases you may have extras in one or more of the sizes. This must be accounted for in your planning and design.

Percentages are based on area by paver.

**1-PIECE RUNNING BOND PATTERN**

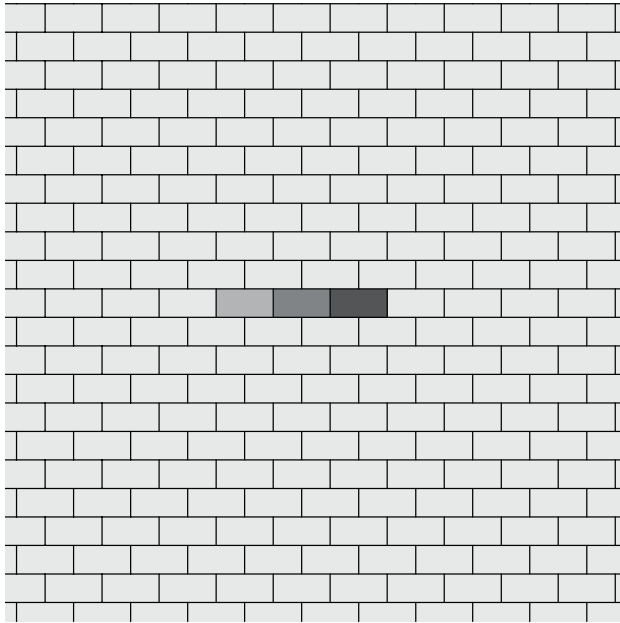

**1-PIECE HERRINGBONE PATTERN**

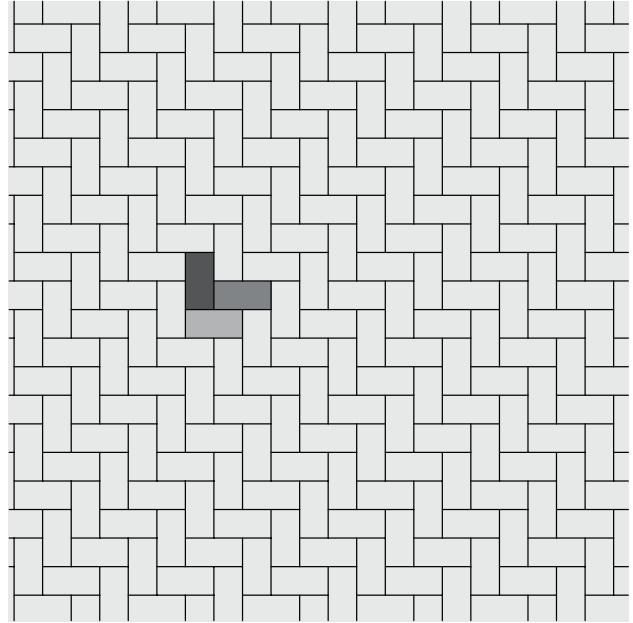

**1-PIECE BASKET WEAVE PATTERN**

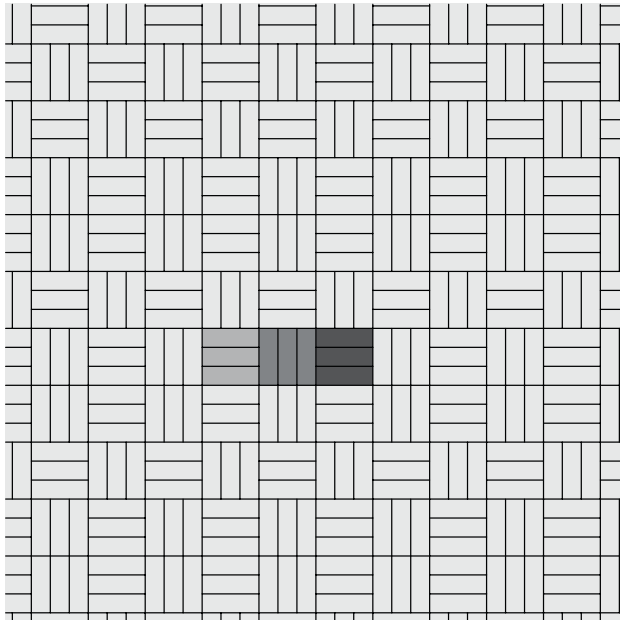





Scan for additional  
product information

PEDESTRIAN	LIGHT/REGULAR TRAFFIC	HEAVY TRAFFIC	PERMEABLE	ADA	COLORTECH PROCESS
✓	✓				✓

## SHAPES & SIZES

### Square



6 x 6 x 2<sup>3</sup>/<sub>8</sub>

### Rectangle



6 x 9 x 2<sup>3</sup>/<sub>8</sub>

UNIT	SQFT/ PALLET	SQFT/ LAYER	LAYER/ PALLET	UNITS/ PALLET	UNITS/ LAYER	SQFT/ UNIT	WEIGHT/ PALLET	LNFT/PALLET (SOLDIER)	LNFT/PALLET (SAILOR)
<b>SQUARE</b>									
<b>SQUARE</b>	120	12	10	480	48	.25	3140	240	240
<b>RECTANGLE</b>									
<b>RECTANGLE</b>	113	11.30	10	300	30	.375	3051	150	225

**NOTES:**

AutoCAD® hatch pattern files can be downloaded from belgard.com for use in architectural drawings.

Some patterns may not necessarily reflect the percentages of stone sizes within a particular pallet. In some cases you may have extras in one or more of the sizes. This must be accounted for in your planning and design.

Percentages are based on area by paver.

6 x 6 Squares

6 x 9 Rectangles

**2-PIECE MUSTER K PATTERN** (25% 6x6 75% 6x9)

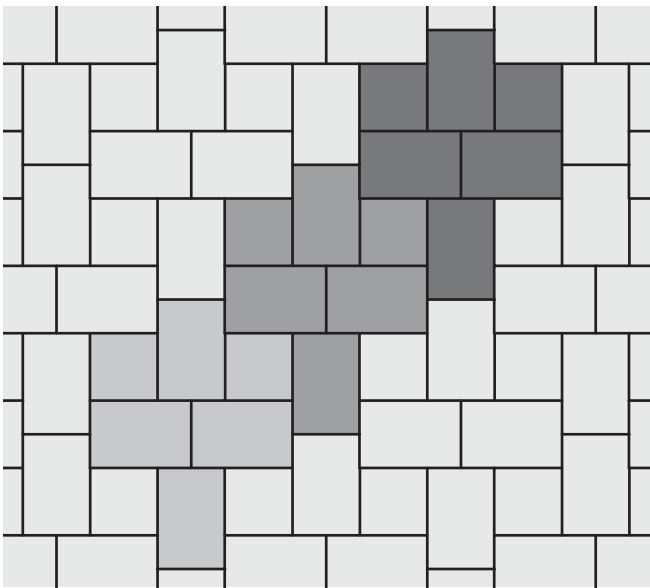

**2-PIECE RUNNING BOND PATTERN**

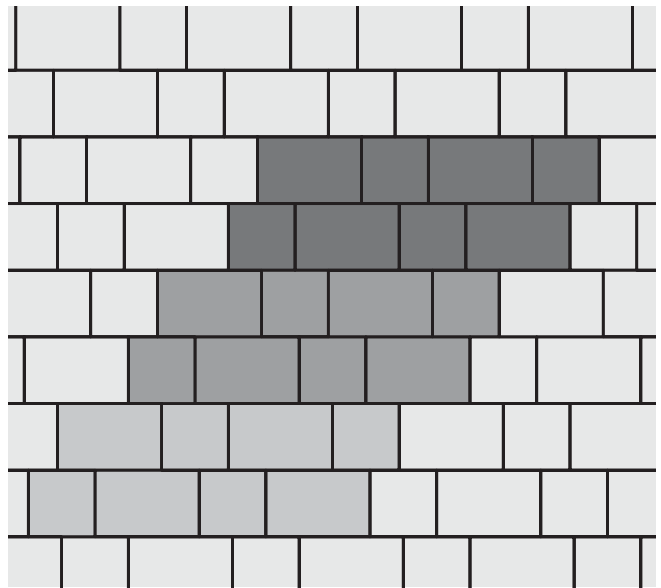

**1-PIECE RUNNING BOND PATTERN**

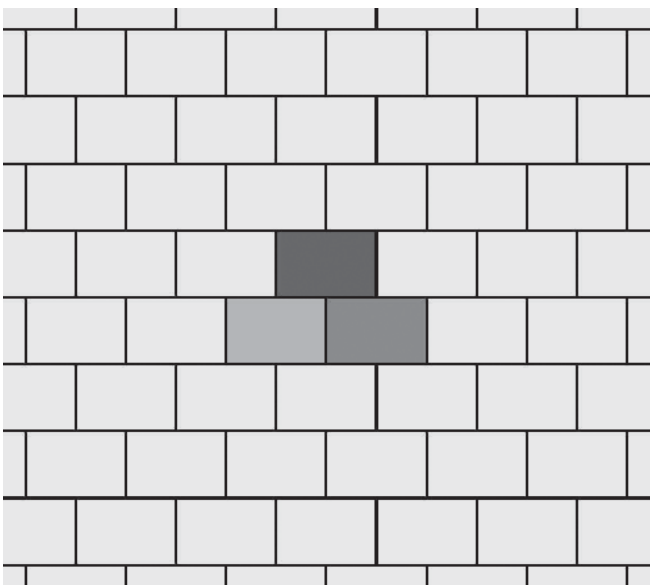



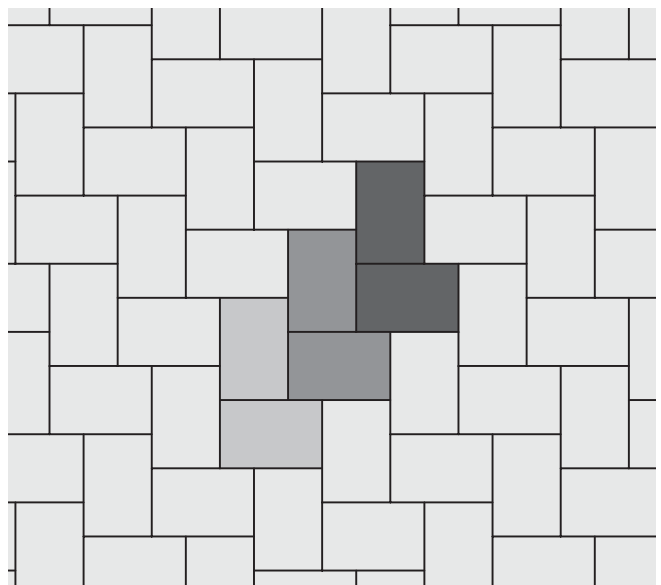



**1-PIECE HERRINGBONE PATTERN**





Scan for additional  
product information

PEDESTRIAN	LIGHT/REGULAR TRAFFIC	HEAVY TRAFFIC	PERMEABLE	ADA	COLORTECH PROCESS
					
✓	✓				✓

## SHAPES & SIZES

### 3-Piece



6 x 6 x 2<sup>3</sup>/<sub>8</sub>



6 x 9 x 2<sup>3</sup>/<sub>8</sub>



6 x 12 x 2<sup>3</sup>/<sub>8</sub>

UNIT	SQFT/ PALLET	SQFT/ LAYER	LAYER/ PALLET	UNITS/ PALLET	UNITS/ LAYER	UNITS/ SQFT	WEIGHT/ PALLET
<b>3-PIECE</b>							
<b>6 X 6 X 2<sup>3</sup>/<sub>8</sub></b>	15	1.5	–	60	6	–	–
<b>6 X 9 X 2<sup>3</sup>/<sub>8</sub></b>	45	4.5	–	120	12	–	–
<b>6 X 12 X 2<sup>3</sup>/<sub>8</sub></b>	45	4.5	–	90	9	–	–
<b>TOTAL</b>	<b>103.88</b>	<b>10.38</b>	<b>10</b>	<b>270</b>	<b>–</b>	<b>–</b>	<b>2909</b>

**NOTES:**

AutoCAD® hatch pattern files can be downloaded from [belgard.com](http://belgard.com) for use in architectural drawings

Some patterns may not necessarily reflect the percentages of stone sizes within a particular pallet. In some cases you may have extras in one or more of the sizes. This must be accounted for in your planning and design.



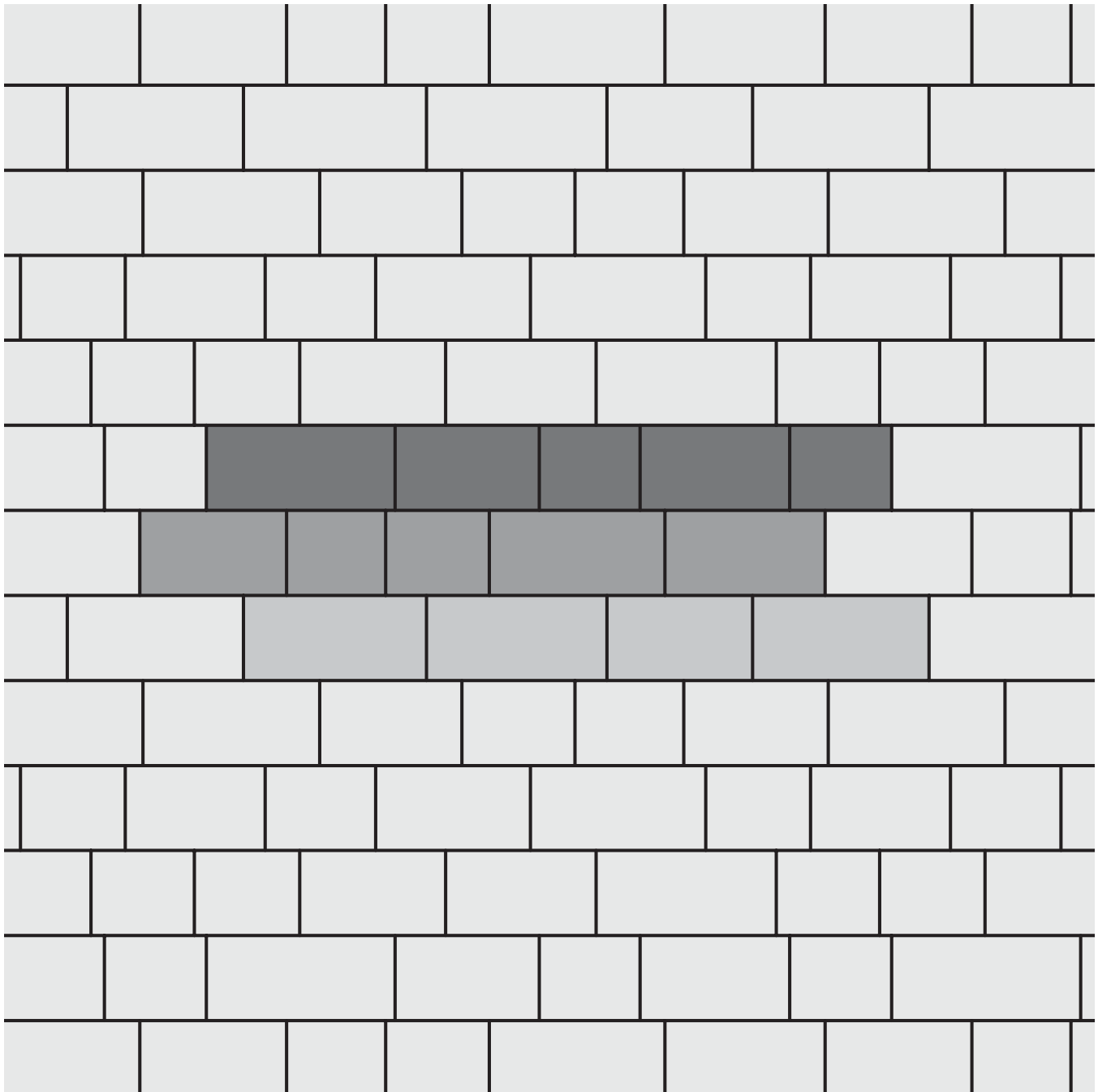



Percentages are based on area by paver.







Scan for additional  
product information

PEDESTRIAN	LIGHT/REGULAR TRAFFIC	HEAVY TRAFFIC	PERMEABLE	ADA	DURAFUSION PROCESS	COLORTECH PROCESS
						
✓	✓*			✓	✓	✓**

\*Only applicable for Dimensions 6 and accents.

\*\*Only applicable for Dimensions 12 and Dimensions 18.

## SHAPES & SIZES

### Dimensions 6\*



3 x 6 x 2<sup>3</sup>/<sub>8</sub>



6 x 6 x 2<sup>3</sup>/<sub>8</sub>



6 x 9 x 2<sup>3</sup>/<sub>8</sub>

### Dimensions 12\*\*



6 x 12 x 2<sup>3</sup>/<sub>8</sub>



12 x 12 x 2<sup>3</sup>/<sub>8</sub>

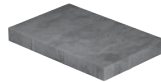

12 x 18 x 2<sup>3</sup>/<sub>8</sub>

### Dimensions 18

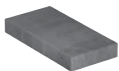

9 x 18 x 2<sup>3</sup>/<sub>8</sub>

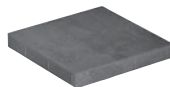

18 x 18 x 2<sup>3</sup>/<sub>8</sub>

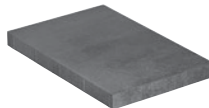

18 x 27 x 2<sup>3</sup>/<sub>8</sub>

### Slab 12 x 24

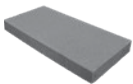

12 x 24 x 2<sup>3</sup>/<sub>8</sub>

### Slab 24 x 24

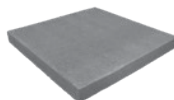

24 x 24 x 2<sup>3</sup>/<sub>8</sub>

### Slab 24 x 36

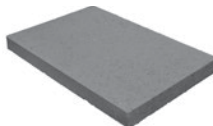

24 x 36 x 2<sup>3</sup>/<sub>8</sub>

### Accent 3 x 9



3 x 9 x 2<sup>3</sup>/<sub>8</sub>

### Accent 6 x 9



6 x 9 x 2<sup>3</sup>/<sub>8</sub>

UNIT	SQFT/ PALLET	SQFT/ LAYER	LAYER/ PALLET	UNITS/ PALLET	UNITS/ LAYER	SQFT/ UNIT	WEIGHT/ PALLET	LNFT/PALLET (SOLDIER)	LNFT/PALLET (SAILOR)
------	-----------------	----------------	------------------	------------------	-----------------	---------------	-------------------	--------------------------	-------------------------

## DIMENSIONS 6

3 X 6 X 2 <sup>3</sup> / <sub>8</sub> 6 X 6 X 2 <sup>3</sup> / <sub>8</sub> 6 X 9 X 2 <sup>3</sup> / <sub>8</sub>	120	12	10	480	48	–	3516	–	240
---	-----	----	----	-----	----	---	------	---	-----

## DIMENSIONS 12

6 X 12 X 2 <sup>3</sup> / <sub>8</sub> 12 X 12 X 2 <sup>3</sup> / <sub>8</sub> 18 X 12 X 2 <sup>3</sup> / <sub>8</sub>	120	12	10	120	12	–	3516	–	120
--	-----	----	----	-----	----	---	------	---	-----

## DIMENSIONS 18

9 X 18 X 2 <sup>3</sup> / <sub>8</sub> 18 X 18 X 2 <sup>3</sup> / <sub>8</sub> 27 X 18 X 2 <sup>3</sup> / <sub>8</sub>	112.5	11.25	10	50	5	–	3296	–	82.5
--	-------	-------	----	----	---	---	------	---	------

## SLABS

12 X 24 X 2 <sup>3</sup> / <sub>8</sub>	120	12	10	60	6	2	3384	60	120
24 X 24 X 2 <sup>3</sup> / <sub>8</sub>	80	8	10	20	2	4	2256	40	40
24 X 36 X 2 <sup>3</sup> / <sub>8</sub>	120	12	10	20	2	6	3516	40	60

## ACCENTS

3 X 9 X 2 <sup>3</sup> / <sub>8</sub>	103.13	10.31	10	550	55	.188	2805	137.5	412.5
6 X 9 X 2 <sup>3</sup> / <sub>8</sub>	112.5	11.25	10	300	30	.375	3296	150	225



**NOTES:**

AutoCAD® hatch pattern files can be downloaded from [belgard.com](http://belgard.com) for use in architectural drawings.

Some patterns may not necessarily reflect the percentages of stone sizes within a particular pallet. In some cases you may have extras in one or more of the sizes. This must be accounted for in your planning and design.

Percentages are based on area by paver.

**Pattern can also be used for Origins 3-Piece, found on page 28.**

**3-PIECE PATTERN A** (Dimensions™ 6 & Dimensions™ 12)

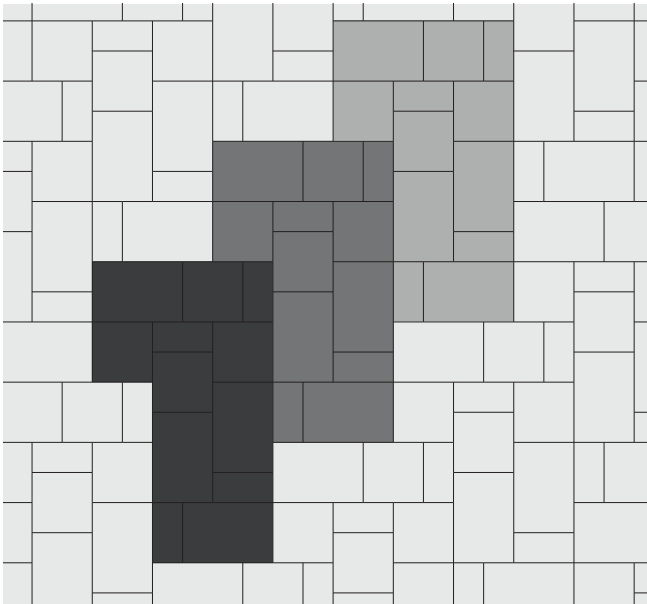

**3-PIECE PATTERN B** (Dimensions™ 18)

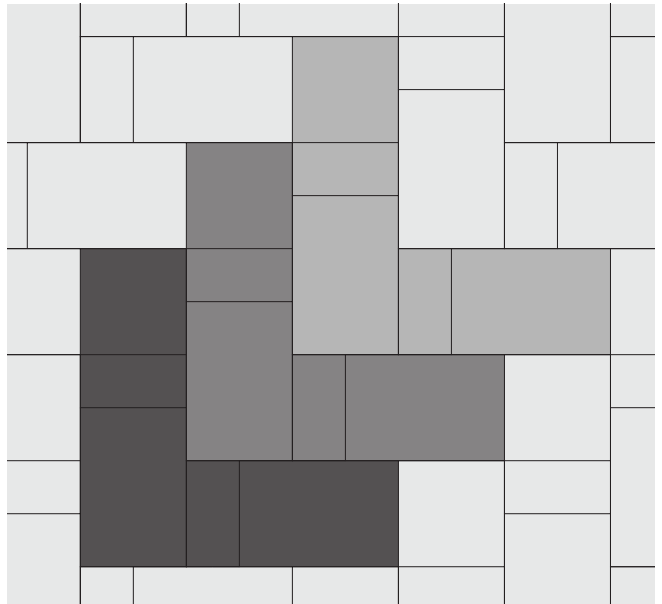

**3-PIECE PATTERN A** (Dimensions™ 18)

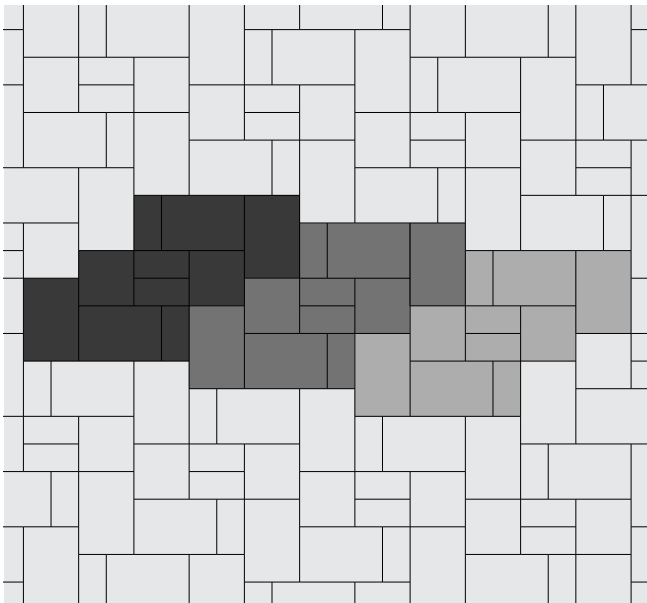



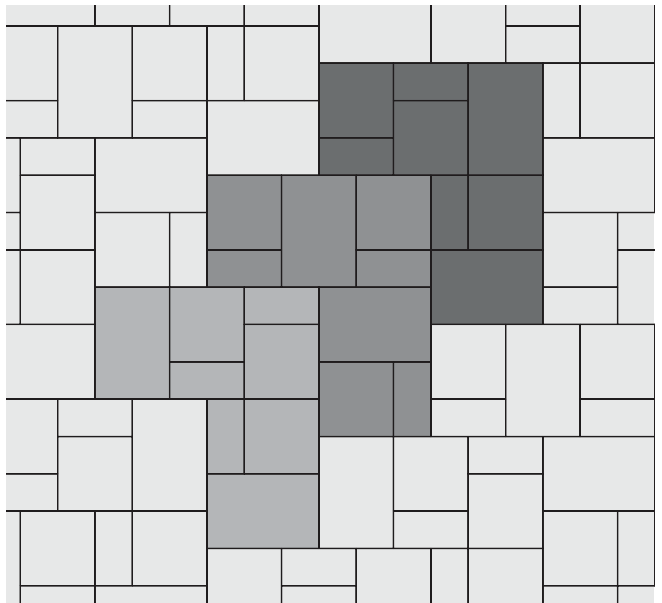



**3-PIECE PATTERN B** (Dimensions™ Stabs 12 x 24, 24 x 24, 24 x 36)





Scan for additional  
product information

PEDESTRIAN	LIGHT/REGULAR TRAFFIC	HEAVY TRAFFIC	PERMEABLE	ADA	DURAFUSION PROCESS
					
✓	✓				

## SHAPES & SIZES

### 3-Piece Modular



3 x 6 x 2<sup>3</sup>/<sub>8</sub>

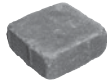

6 x 6 x 2<sup>3</sup>/<sub>8</sub>



6 x 9 x 2<sup>3</sup>/<sub>8</sub>

### Accent



6 x 9 x 2<sup>3</sup>/<sub>8</sub>

### Circle Kit



5<sup>7</sup>/<sub>8</sub> x Variable x 2<sup>3</sup>/<sub>8</sub>



UNIT	SQFT/ PALLET	SQFT/ LAYER	LAYER/ PALLET	UNITS/ PALLET	UNITS/ LAYER	SQFT/ UNIT	WEIGHT/ PALLET	LNFT/PALLET (SOLDIER)	LNFT/PALLET (SAILOR)
------	-----------------	----------------	------------------	------------------	-----------------	---------------	-------------------	--------------------------	-------------------------

### 3-PIECE MODULAR

<b>TWINKIE</b>	21.35	1.94	–	176	16	.125	577.28	–	42.17
<b>SQUARE</b>	42.63	3.88	–	176	16	.25	1151.04	–	85.25
<b>RECTANGLE</b>	64.02	5.85	–	176	16	.375	1726.56	–	128.78
<b>TOTAL</b>	128	11.64	11	528	–	–	3455	–	256.18

### ACCENT

<b>ACCENT</b>	112.5	11.25	10	300	30	.375	2981	150	225
---------------	-------	-------	----	-----	----	------	------	-----	-----

### CIRCLE KIT

<b>CIRCLE KIT</b>	73	7.3	10	420	42	–	2992	–	–
-------------------	----	-----	----	-----	----	---	------	---	---

**NOTES:**

AutoCAD® hatch pattern files can be downloaded from [belgard.com](http://belgard.com) for use in architectural drawings.

Some patterns may not necessarily reflect the percentages of stone sizes within a particular pallet. In some cases you may have extras in one or more of the sizes. This must be accounted for in your planning and design.

6 x 3 Small Rectangle

6 x 6 Medium Square

6 x 9 Large Rectangle

**3-PIECE PATTERN A**

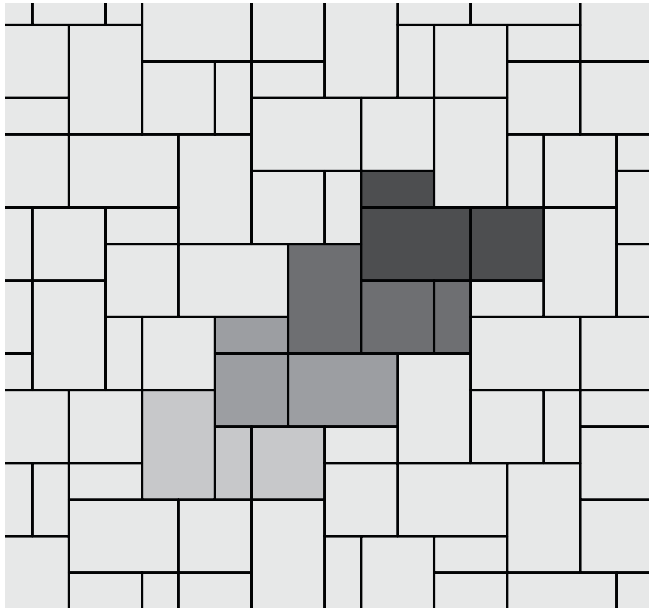

**3-PIECE RUNNING BOND**

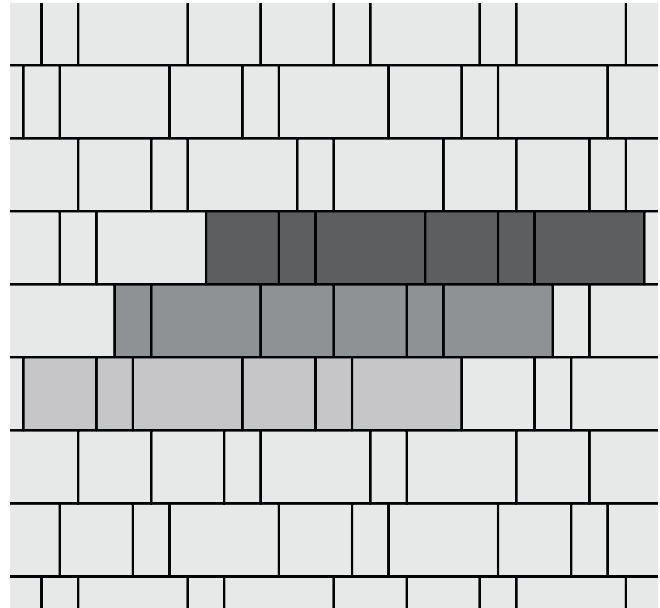

**NOTES:**

AutoCAD® hatch pattern files can be downloaded from [belgard.com](http://belgard.com) for use in architectural drawings

Some patterns may not necessarily reflect the percentages of stone sizes within a particular pallet. In some cases you may have extras in one or more of the sizes. This must be accounted for in your planning and design.

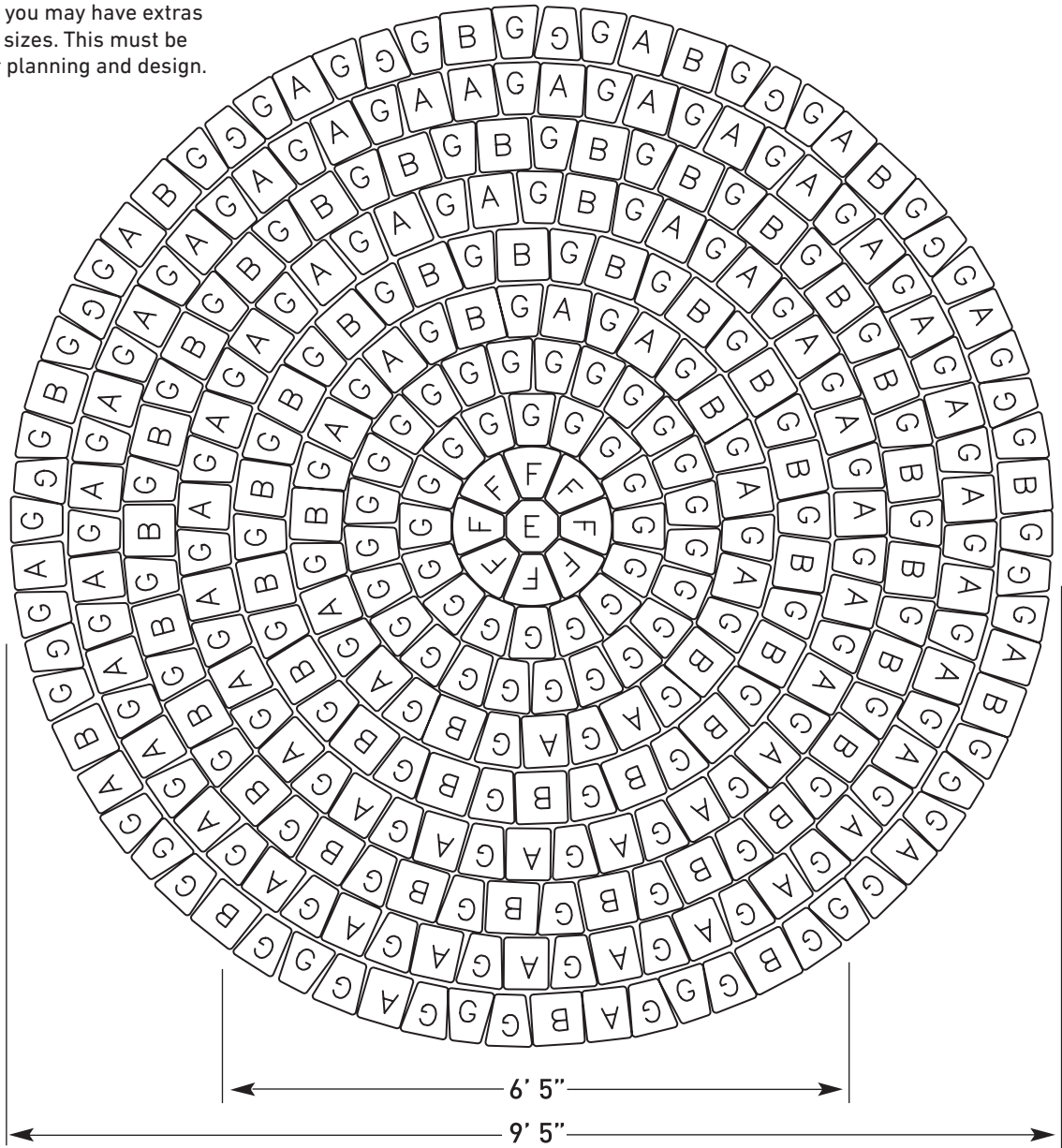

To get a complete circle, be sure to follow the laying order illustrated at left.

**UNIT SIZES**



Each pallet contains enough pavers for:

2 circles with diameters 6' 5"

or

1 circle with diameter 9' 5"

Note: For larger circle, combined 2 circle kits to make a circle with diameter of 13'6"

\* Each pallet layer contains one Mold Filler Piece A and B. They are not used in the Dublin Circle Layout. Each piece is accounted for in weights mentioned in the table below. Square footage does not account for these pieces. Their purpose is solely for packaging and shipping stability.



Scan for additional product information

PEDESTRIAN	LIGHT/REGULAR TRAFFIC	HEAVY TRAFFIC	PERMEABLE	ADA	DURAFUSION PROCESS	COLORTECH PROCESS
✓	✓			✓	✓*	✓*

\*Available with either DuraFusion or ColorTech

## SHAPES & SIZES

### 60mm

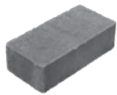

4 x 8 x 2<sup>3</sup>/<sub>8</sub>

UNIT	SQFT/PALLET	SQFT/LAYER	LAYER/PALLET	UNITS/PALLET	UNITS/LAYER	SQFT/UNIT	WEIGHT/PALLET	LNFT/PALLET (SOLDIER)	LNFT/PALLET (SAILOR)
------	-------------	------------	--------------	--------------	-------------	-----------	---------------	-----------------------	----------------------

#### 60mm with ColorTech

4 X 8 X 2 <sup>3</sup> / <sub>8</sub>	120	12	10	540	54	.2222	3112	180	360
---------------------------------------	-----	----	----	-----	----	-------	------	-----	-----

#### 60mm with DuraFusion

4 X 8 X 2 <sup>3</sup> / <sub>8</sub>	120	12	10	540	54	.2222	3516	180	360
---------------------------------------	-----	----	----	-----	----	-------	------	-----	-----



**NOTES:**

AutoCAD® hatch pattern files can be downloaded from [belgard.com](http://belgard.com) for use in architectural drawings.

Some patterns may not necessarily reflect the percentages of stone sizes within a particular pallet. In some cases you may have extras in one or more of the sizes. This must be accounted for in your planning and design.

Percentages are based on area by paver.

100% 4 x 8

Pattern can also be used for Brooklyn found on page 9, and Aqualine found on page 34.

**1-PIECE RUNNING BOND PATTERN**

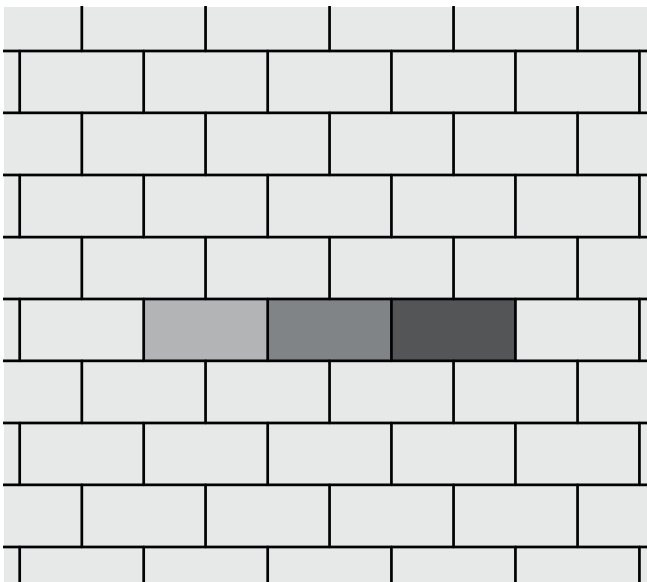

**1-PIECE HERRINGBONE PATTERN**

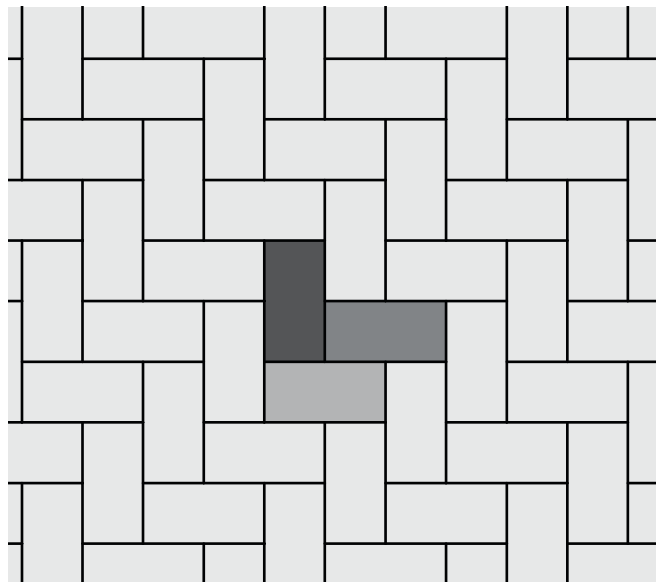



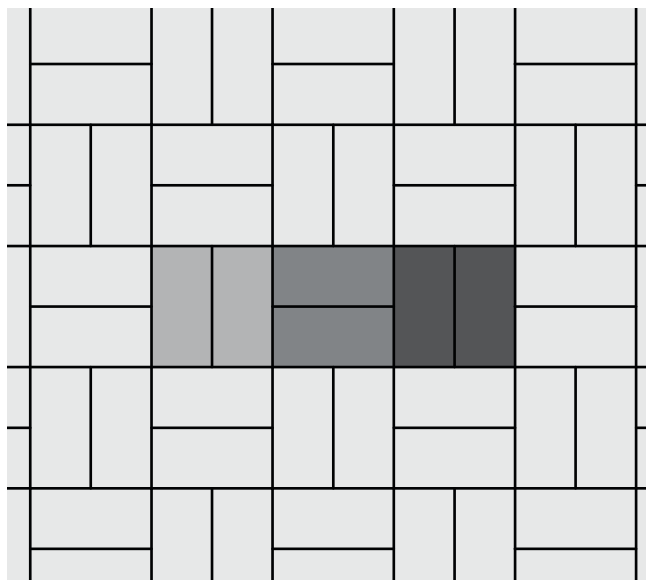

**1-PIECE BASKET WEAVE PATTERN**





Scan for additional  
product information

PEDESTRIAN	LIGHT/REGULAR TRAFFIC	HEAVY TRAFFIC	PERMEABLE	ADA
				
✓				

## SHAPES & SIZES

### Small Unit



16¼ x 23¾ x 2¾

### Large Unit



16¼ x 31 x 2¾

UNIT	SQFT/ PALLET	SQFT/ LAYER	LAYER/ PALLET	UNITS/ PALLET	UNITS/ LAYER	UNITS/ SQFT	WEIGHT/ PALLET	LNFT/PALLET (SOLDIER)	LNFT/PALLET (SAILOR)
60mm									
<b>TOTAL</b>	86	8.60	10	40	4	–	2427	–	–



**NOTES:**

AutoCAD® hatch pattern files can be downloaded from [belgard.com](http://belgard.com) for use in architectural drawings

Some patterns may not necessarily reflect the percentages of stone sizes within a particular pallet. In some cases you may have extras in one or more of the sizes. This must be accounted for in your planning and design.

23% 15<sup>5</sup>/<sub>6</sub> x 22 Units

77% 15<sup>1</sup>/<sub>2</sub> x 29<sup>3</sup>/<sub>4</sub> Units

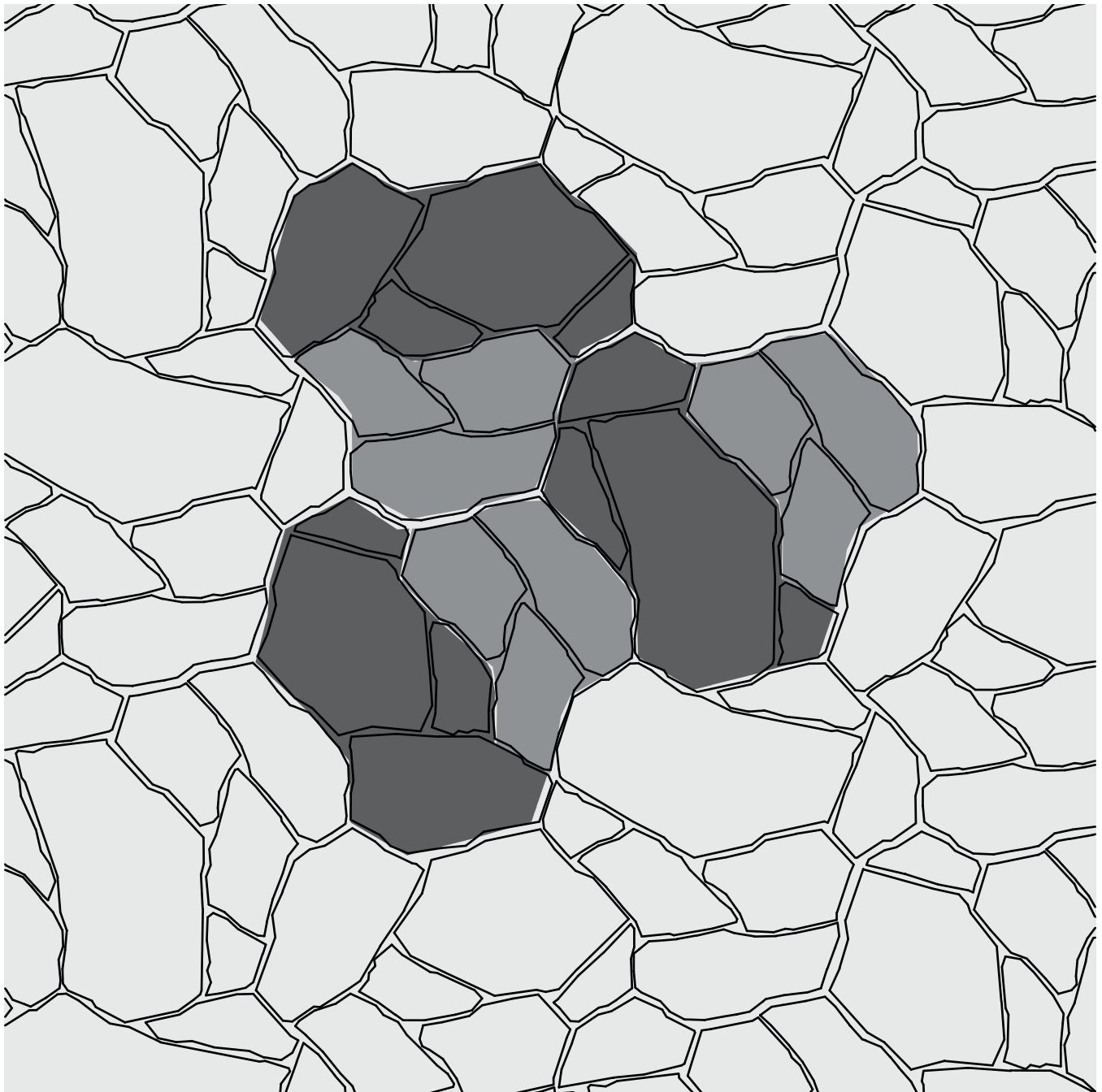

# GEOMETRIC SHAPES



Scan for additional product information

PEDESTRIAN	LIGHT/REGULAR TRAFFIC	HEAVY TRAFFIC	PERMEABLE	ADA	DURAFUSION PROCESS	COLORTECH PROCESS
✓				✓		✓

## SHAPES & SIZES

### Hexagon



10<sup>7</sup>/<sub>16</sub> x 11<sup>7</sup>/<sub>8</sub> x 2<sup>3</sup>/<sub>8</sub>

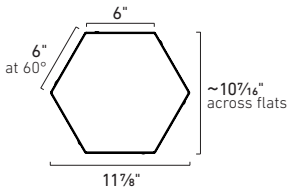

### Diamond



12 x 12 x 2<sup>3</sup>/<sub>8</sub>

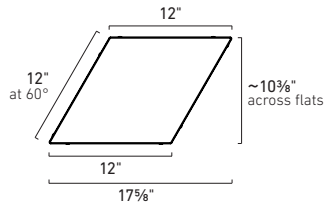

### 3 x 12 Parallelogram



3 x 12 x 2<sup>3</sup>/<sub>8</sub>

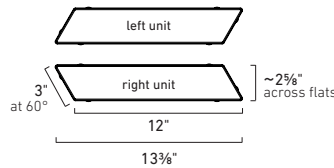

### 6 x 18 Parallelogram

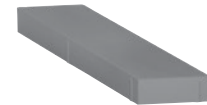

6 x 18 x 2<sup>3</sup>/<sub>8</sub>

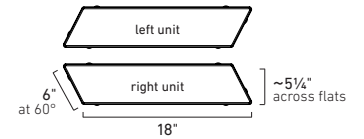

UNIT	SQFT/PALLET	SQFT/LAYER	LAYER/PALLET	UNITS/PALLET	UNITS/LAYER	SQFT/UNIT	WEIGHT/PALLET	LNFT/PALLET (SOLDIER)	LNFT/PALLET (SAILOR)
<b>HEXAGON</b>									
10 <sup>7</sup> / <sub>16</sub> X 11 <sup>7</sup> / <sub>8</sub> X 2 <sup>3</sup> / <sub>8</sub>	100.02	8.34	12	108	9	.861	2664	-	-
<b>DIAMOND</b>									
12 X 12 X 2 <sup>3</sup> / <sub>8</sub>	93.53	7.79	12	108	9	1	2664	-	-
<b>3 X 12 PARALLELOGRAM</b>									
3 X 12 X 2 <sup>3</sup> / <sub>8</sub>	85.73	7.79	11	396	36	.25	2664	-	-
<b>6 X 18 PARALLELOGRAM</b>									
6 X 18 X 2 <sup>3</sup> / <sub>8</sub>	114.31	10.39	11	176	16	.75	3165	-	-



**NOTES:**





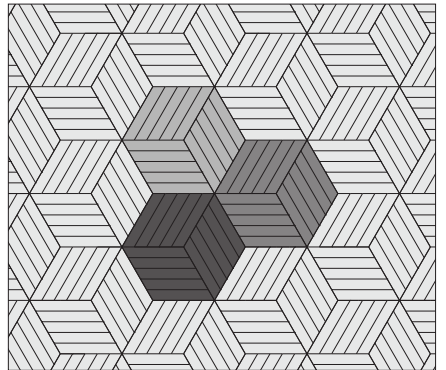
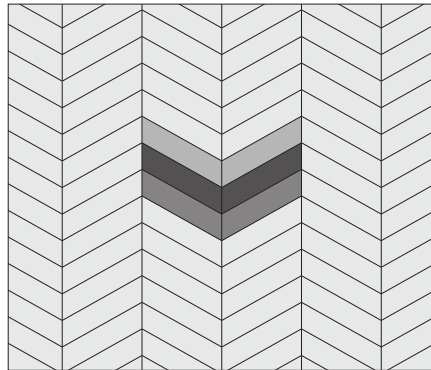
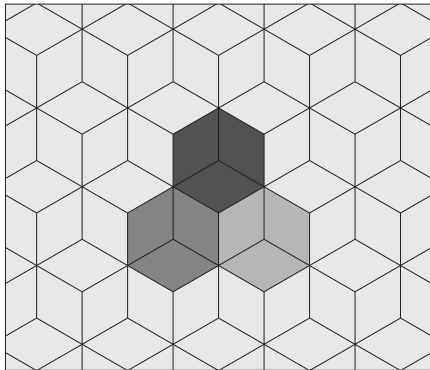
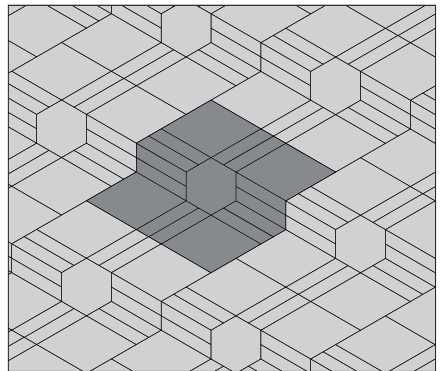
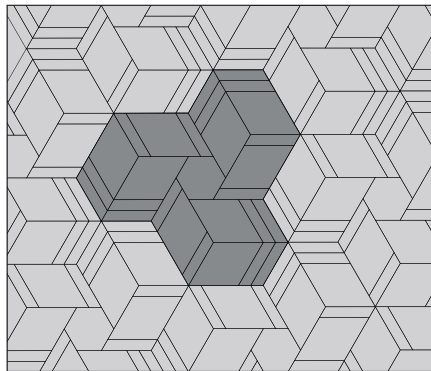
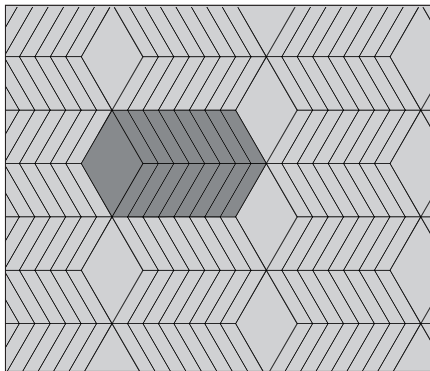
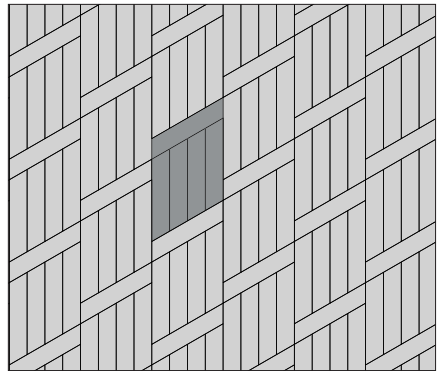
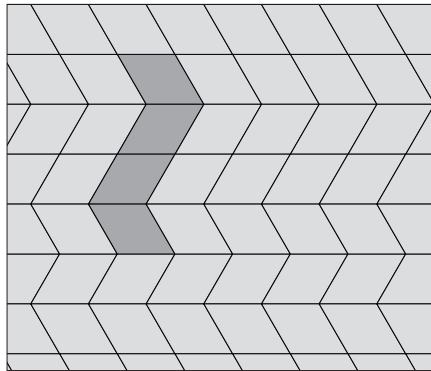
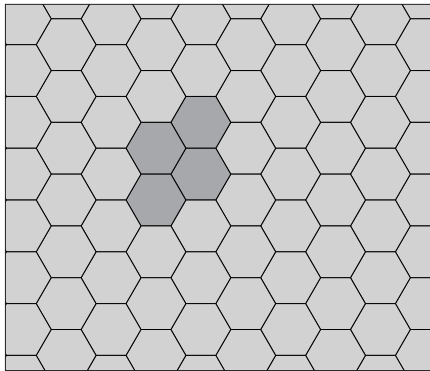

AutoCAD® hatch pattern files can be downloaded from [belgard.com](http://belgard.com) for use in architectural drawings.

Some patterns may not necessarily reflect the percentages of stone sizes within a particular pallet. In some cases you may have extras in one or more of the sizes. This must be accounted for in your planning and design.





Scan for additional  
product information

PEDESTRIAN	LIGHT/REGULAR TRAFFIC	HEAVY TRAFFIC	PERMEABLE	ADA	DURAFUSION PROCESS	COLORTECH PROCESS
						
✓	✓*			✓	✓	✓**

\*Only applicable for Origins 6 and accents.

\*\*Only applicable for Origins12 and Origins 18.

## SHAPES & SIZES

### Origins 6



3 x 6 x 2<sup>3</sup>/<sub>8</sub>



6 x 6 x 2<sup>3</sup>/<sub>8</sub>



6 x 9 x 2<sup>3</sup>/<sub>8</sub>

### Origins 12



6 x 12 x 2<sup>3</sup>/<sub>8</sub>

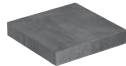

12 x 12 x 2<sup>3</sup>/<sub>8</sub>



12 x 18 x 2<sup>3</sup>/<sub>8</sub>

### Origins 18

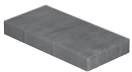

9 x 18 x 2<sup>3</sup>/<sub>8</sub>

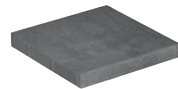

18 x 18 x 2<sup>3</sup>/<sub>8</sub>

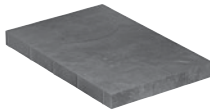

18 x 27 x 2<sup>3</sup>/<sub>8</sub>

### Accent

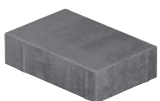

6 x 9 x 2<sup>3</sup>/<sub>8</sub>

UNIT	SQFT/ PALLET	SQFT/ LAYER	LAYER/ PALLET	UNITS/ PALLET	UNITS/ LAYER	SQFT/ UNIT	WEIGHT/ PALLET	LNFT/PALLET (SOLDIER)	LNFT/PALLET (SAILOR)
<b>ORIGINS 6</b>									
3 X 6 X 2 <sup>3</sup> / <sub>8</sub> 6 X 6 X 2 <sup>3</sup> / <sub>8</sub> 6 X 9 X 2 <sup>3</sup> / <sub>8</sub>	120	12	10	480	48	–	3516	–	240
<b>ORIGINS 12</b>									
6 X 12 X 2 <sup>3</sup> / <sub>8</sub> 12 X 12 X 2 <sup>3</sup> / <sub>8</sub> 12 X 18 X 2 <sup>3</sup> / <sub>8</sub>	120	12	10	120	12	–	3516	–	120
<b>ORIGINS 18</b>									
9 X 18 X 2 <sup>3</sup> / <sub>8</sub> 18 X 18 X 2 <sup>3</sup> / <sub>8</sub> 18 X 27 X 2 <sup>3</sup> / <sub>8</sub>	112.5	11.25	10	50	5	–	3296	–	225
<b>ACCENT</b>									
6 X 9 X 2 <sup>3</sup> / <sub>8</sub>	112.5	11.25	10	320	30	.375	3296	160	240



Scan for additional  
product information

PEDESTRIAN	LIGHT/REGULAR TRAFFIC	HEAVY TRAFFIC	PERMEABLE	ADA	DURAFUSION PROCESS
✓				✓	✓

## SHAPES & SIZES

### 3-Piece



9 x 18 x 2<sup>3</sup>/<sub>8</sub>



18 x 18 x 2<sup>3</sup>/<sub>8</sub>



27 x 18 x 2<sup>3</sup>/<sub>8</sub>

UNIT	SQFT/ PALLET	SQFT/ LAYER	LAYER/ PALLET	UNITS/ PALLET	UNITS/ LAYER	SQFT/ UNIT	WEIGHT/ PALLET	LNFT/PALLET (SOLDIER)	LNFT/PALLET (SAILOR)
<b>3-PIECE</b>									
9 X 18 X 2 <sup>3</sup> / <sub>8</sub> 18 X 18 X 2 <sup>3</sup> / <sub>8</sub> 27 X 18 X 2 <sup>3</sup> / <sub>8</sub>	112.5	11.25	10	50	5	—	3296	—	82.5



**NOTES:**

AutoCAD® hatch pattern files can be downloaded from [belgard.com](http://belgard.com) for use in architectural drawings

Some patterns may not necessarily reflect the percentages of stone sizes within a particular pallet. In some cases you may have extras in one or more of the sizes. This must be accounted for in your planning and design.

Percentages are based on area by paver.

**3-PIECE PATTERN A**

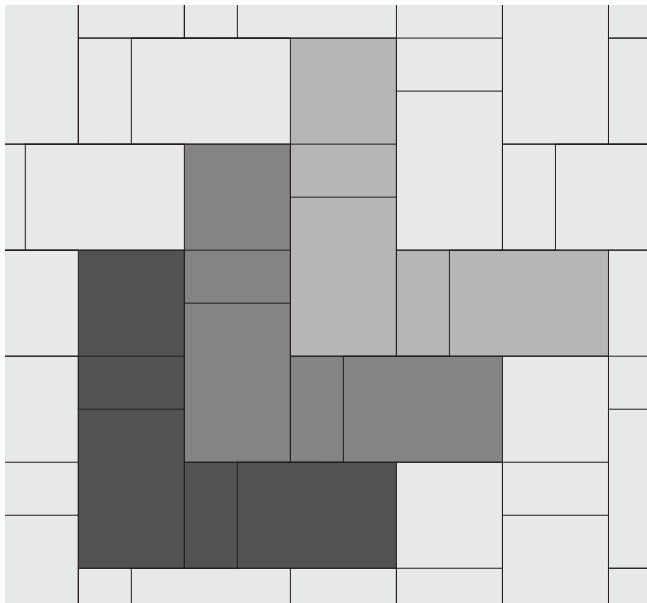

**3-PIECE PATTERN B**

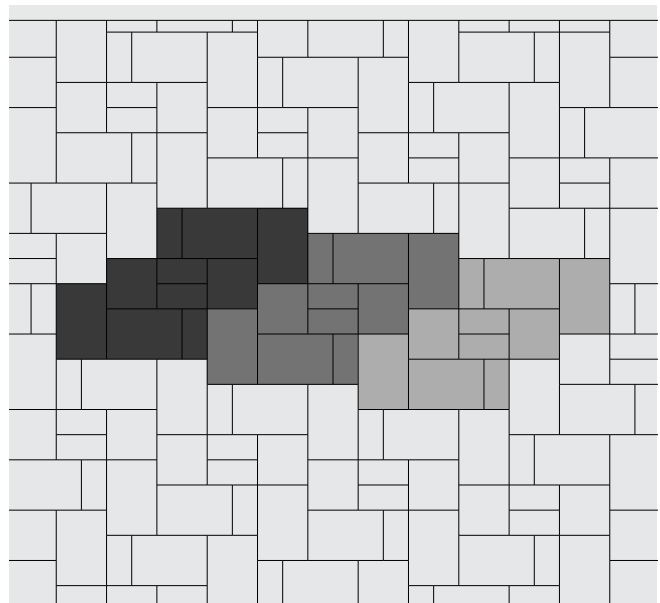

# PERMEABLE PAVERS

## PERMEABLE PAVER INSTALLATION GUIDE

33 Basic PICP Systems

## PERMEABLE PAVERS

34 Aqualine™

35 Turfstone™

For basic paver installation information  
visit [icpi.org](http://icpi.org)

# PERMEABLE INTERLOCKING CONCRETE PAVEMENT (PICP)

**PICP TYPICAL CROSS SECTION**

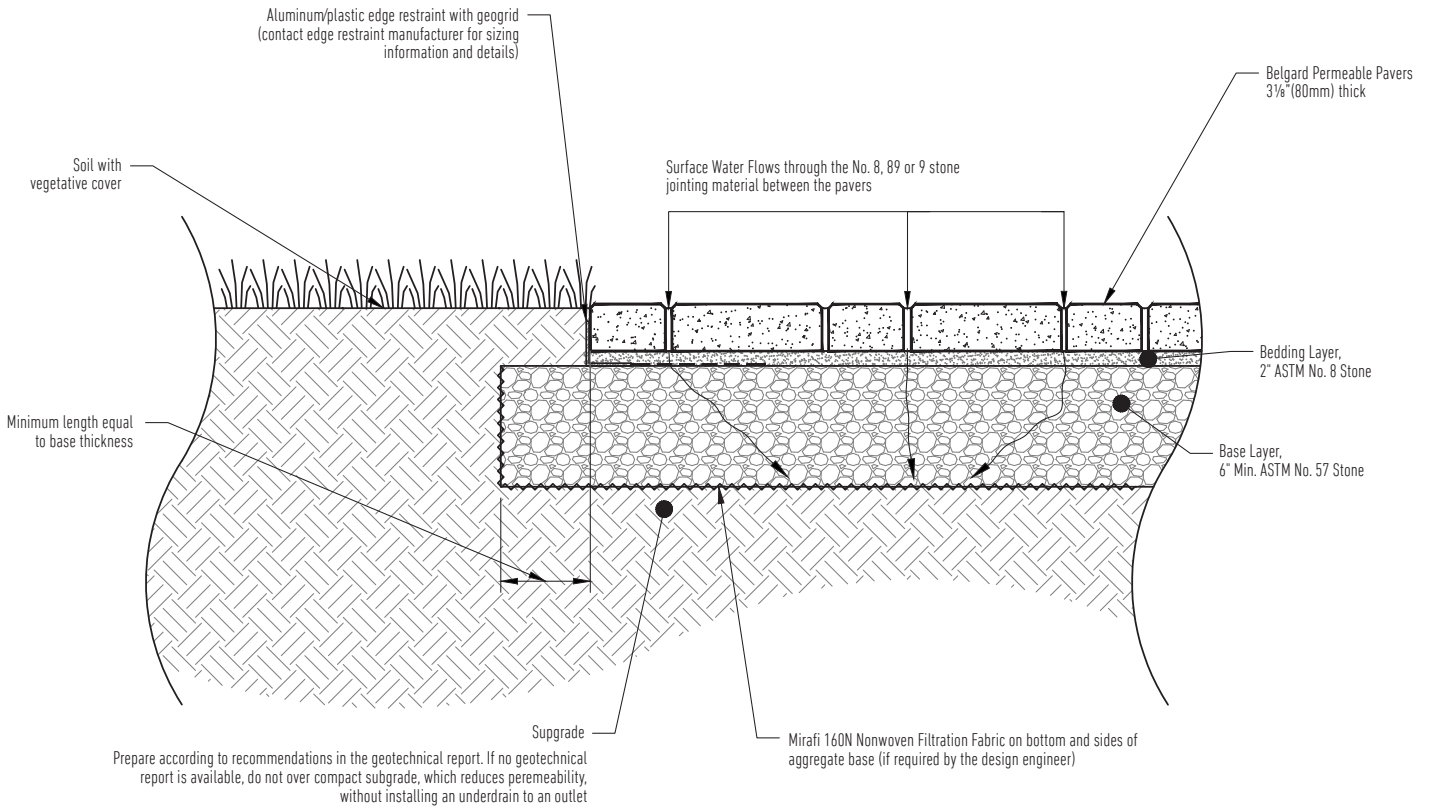
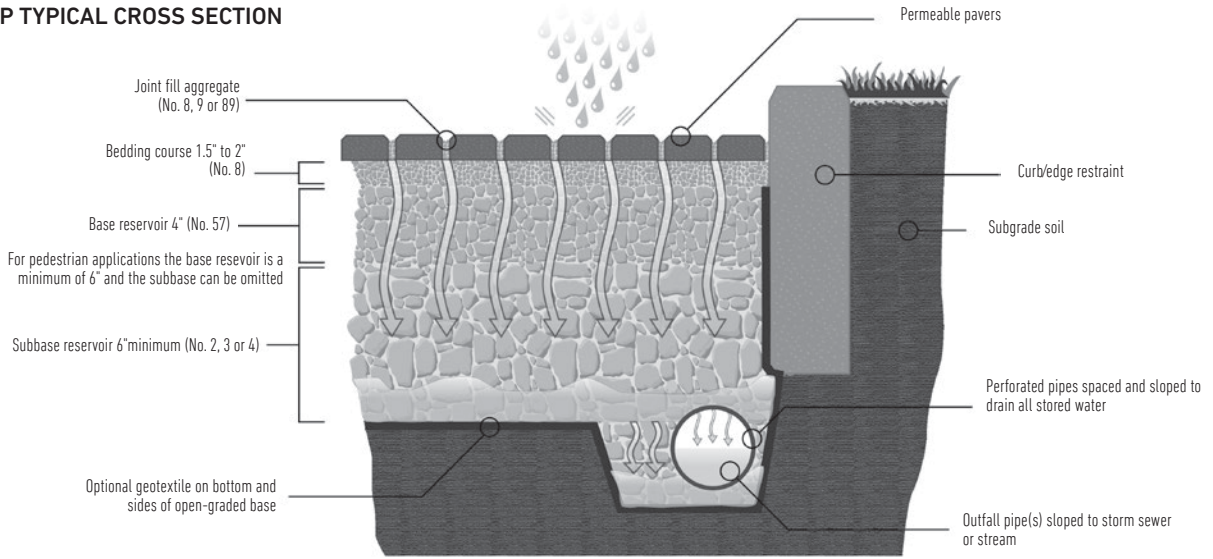

Prepare according to recommendations in the geotechnical report. If no geotechnical report is available, do not over compact subgrade, which reduces permeability, without installing an underdrain to an outlet

Mirafli 160N Nonwoven Filtration Fabric on bottom and sides of aggregate base (if required by the design engineer)

**Design Notes:**







1. Cross section as shown is suitable for pedestrian applications and residential driveways, patios, and sidewalks.
2. Depth of aggregate base subject to site specific conditions (soil conditions, groundwater levels, climatic conditions). Contact local Belgard sales representative.
3. Drain pipes may be required within the aggregate base depending on the permeability of the subgrade soils. Verify drainage needs with the geotechnical engineer. Ensure drain pipes are able to daylight via gravity flow to surface, or connect to catch basin.





Scan for additional  
product information

Pattern found on page 23

PEDESTRIAN	LIGHT/REGULAR TRAFFIC	HEAVY TRAFFIC	PERMEABLE	ADA	TEXTUREGUARD PROCESS
					
✓	✓	✓	✓	✓	

## SHAPES & SIZES

### 80mm









4½ x 9 x 3⅛

UNIT	SQFT/ PALLET	SQFT/ LAYER	LAYER/ PALLET	UNITS/ PALLET	UNITS/ LAYER	SQFT/ UNIT	WEIGHT/ PALLET
<b>80MM</b>							
4½ X 9 X 3⅛	90	11.25	8	320	40	.2812	3375



Scan for additional  
product information

PEDESTRIAN	LIGHT/REGULAR TRAFFIC	HEAVY TRAFFIC	PERMEABLE	ADA	TEXTUREGUARD PROCESS
					
✓	✓		✓		

## SHAPES & SIZES

### Turfstone Unit



15<sup>3</sup>/<sub>4</sub> x 23<sup>5</sup>/<sub>8</sub> x 3<sup>1</sup>/<sub>8</sub>

UNIT	SQFT/ PALLET	SQFT/ LAYER	LAYER/ PALLET	UNITS/ PALLET	UNITS/ LAYER	SQFT/ UNIT	WEIGHT/ PALLET
------	-----------------	----------------	------------------	------------------	-----------------	---------------	-------------------

### TURFSTONE UNIT

15 <sup>3</sup> / <sub>4</sub> X 23 <sup>5</sup> / <sub>8</sub> X 3 <sup>1</sup> / <sub>8</sub>	103.2	12.9	8	40	5	2.58	2377
---	-------	------	---	----	---	------	------



**NOTES:**

AutoCAD® hatch pattern files can be downloaded from [belgard.com](http://belgard.com) for use in architectural drawings

Some patterns may not necessarily reflect the percentages of stone sizes within a particular pallet. In some cases you may have extras in one or more of the sizes. This must be accounted for in your planning and design.

100% 15<sup>3</sup>/<sub>4</sub> x 23<sup>5</sup>/<sub>8</sub> Units

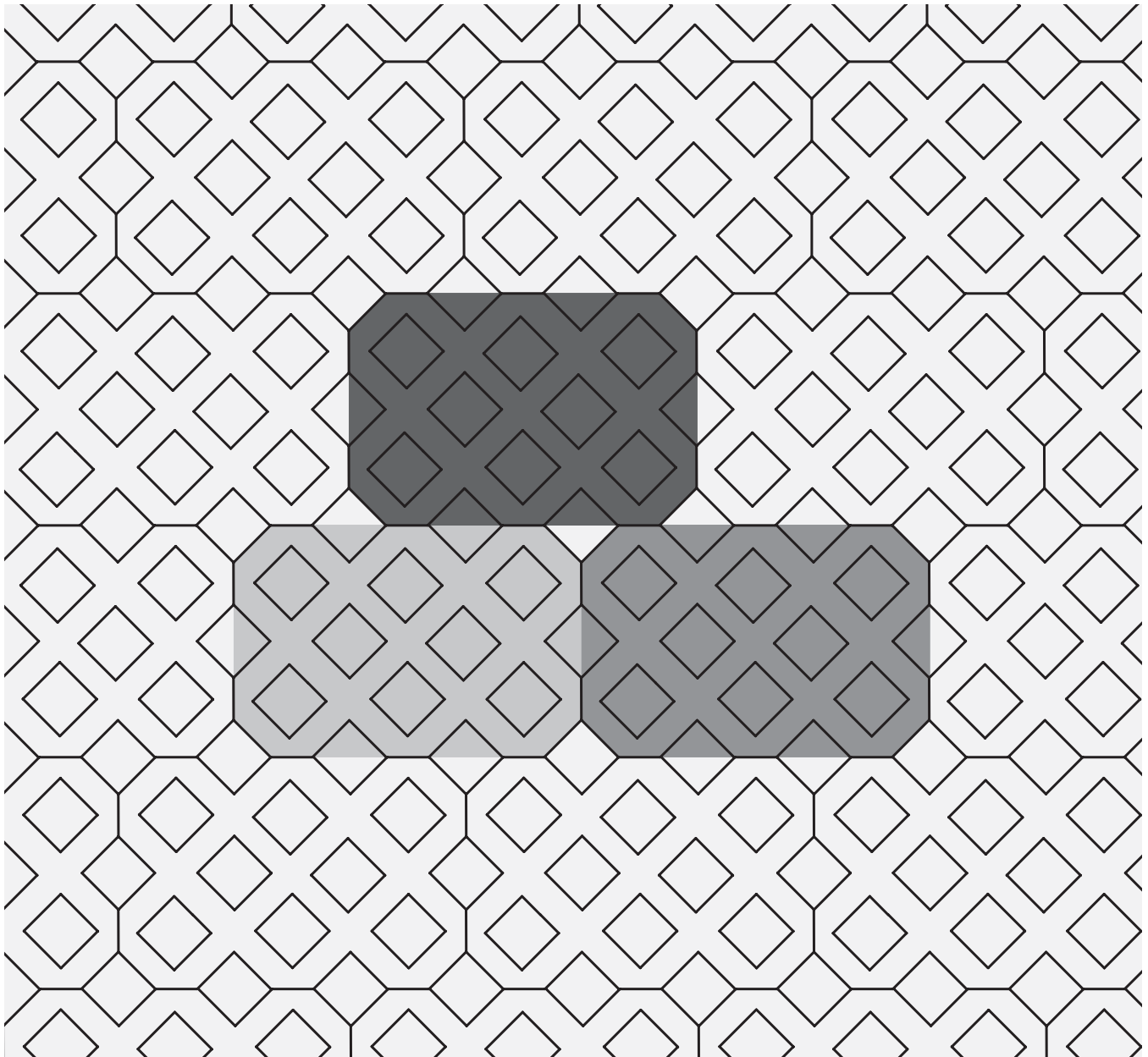

# PORCELAIN PAVERS & PLANKS

## PORCELAIN INSTALLATION GUIDE

- 38 Porcelain Paver Advantages
- 38 Specialty Tools for Porcelain Pavers Construction
- 39 Cleaning & Maintenance For Porcelain Products
- 39 Porcelain Paver Installation

## PORCELAIN PAVERS & PLANKS

- 40 Glocal
- 41 Lagoon
- 42 Noon
- 43 Quarziti 2.0
- 44 Verona™
- 45 Unico Coping

For basic paver installation information  
visit [icpi.org](http://icpi.org)

# PORCELAIN PAVERS

Belgard Porcelain Pavers are formed by pressing, followed by vitrification: this process involves the total fusion into a single material made from natural raw materials (sand, quartz, feldspars, kaolin, clays and inorganic pigments) which, fired at temperatures above 1226.67° C (2240° F), are transformed into a product with exceptional hardness, ultra-low absorption rate and unmatched mechanical characteristics. Belgard porcelain pavers are eco-compatible and ecolabel-certified. Each unit is 20mm (0.7874") standard thickness or ¾" nominal thickness and is durable enough to withstand use in exterior applications.

## PORCELAIN PAVERS ADVANTAGES:

- **Freeze thaw resistant**—They are 100% frost-free and their properties remain unaltered at temperatures ranging from -51.1° to + 60° C (-60° F to +140°F).
- **Color durability**—Color is fused by vitrification, becomes an integral part of the porcelain surface and is not affected by elements.
- **Easy installation**—Perfect fit and for fast installs.
- **Low absorption rate**—Spills, salt and other materials will not seep into pours.
- **Easy to clean**—Household cleaners can be used to wipe down spills and dirt; can even be pressure washed with a low pressure washing device. \*See pressure washing warning below.
- **Stylish**—Matches what homeowners are currently doing inside the home.
- **Durable**—High breakage loads of up to 3,587 lbs (1,627 kg) per foot based on ASTM-C648.
- **Resistant**— High compressive strength and ultra-low absorption rate creates a dense surface that resists mold, moss, dirt and other staining.
- **Skid-resistant**—Structured paver top textures create slip resistant surfaces for safety; perfect for around pools/spas or in wet climates.
- **Modular Design**—Superior accuracy in dimensional sizing and linear sides, the slabs allow for perfectly executed installations with tight and accurate lines.
- **Light weight**—16.8 kg (37 lbs) for the 24"x24" paver permit for easy installation, removal and serviceability and even reusability (Excluding adhered installations).
- Available in colors that have an SRI that qualifies for a LEED certification. The SRI on some units ranges between 60-80. To receive LEED credit, the SRI must be at least 29.
- **Impermeable**— Deicing salt and other deicing materials can be used without concern of damage.

\* It is important that all pressure washing of your porcelain pavers be done with a low pressure washer with a maximum of 1600 psi and nothing more powerful. When pressure washing your installation, care should be taken to prevent damage to the grout (adhesive and grout installations) and some re-sanding will be necessary when power washing an installation with sand or polymeric sand joints.

## SPECIALTY TOOLS FOR PORCELAIN PAVER CONSTRUCTION:

- Wet cut tile saw equipped with a diamond blade manufactured for wet cutting porcelain. The saw should be designed to safely cut a 24 inch length porcelain paver.
- A paver clamp for easy handling, which can be used to both install and remove pavers.
- The use of gloves is highly recommended while handling and installing porcelain slabs.
- Appropriate notched trowels and grout float tools for cementitious adhesive and grout installation. The appropriate tool selection would be based on the adhesive and grout manufacturer's recommendation.
- Pallets of porcelain pavers are manufactured and shipped with a Heavy Duty plastic protective pallet cover and the individual porcelain pavers are packaged in protective cardboard boxes. To prevent damage to your pavers, do not remove the protective cardboard boxes until you are ready to install them.
- Caution: Removing pavers from their protective packaging and handling multiple loose stones together creates the possibility for chipping.

Once the Heavy Duty plastic pallet covers have been removed from the pallet, the unused boxed pavers should be protected from the elements to insure the integrity of the protective cardboard boxes.

## CLEANING & MAINTENANCE FOR PORCELAIN PRODUCTS

Post-laying cleaning is obligatory after on-site works. Inadequate or late removal of the grouting used on the joints can leave marks difficult to remove and create, on the flooring, a cement film able to absorb all types of dirt, thus giving the impression that it is the material that has become dirty.

It is indispensable to dissolve and remove these residues completely using buffered acids diluted in water (follow the instructions on the packs of the products used), which must then be removed completely and quickly, rinsing the floor with plenty of water to avoid residues or drops on the floor which could damage the tiles.

Allow the product to act on the wet floor, without letting it dry and rubbing it with colorless rags. Next, rinse it thoroughly with water to ensure that the floor is free of detergent residues. If necessary, repeat the operation.

We suggest performing a preliminary wash on a sample surface of a few square meters; if the test is successful, extend clearing over the entire surface. When you have done the above wash, carry out a basic or alkaline wash using degreasing detergents. This is because acid can leave grease on the floor, which could contribute to retaining dirt.

## PORCELAIN PAVER INSTALLATION

Each of the following option details will include specific information relative to the selected installation. Base thicknesses vary between different geographical and climatic locations and the contractor will be installing typical base thicknesses for paving installations in their location.

Installing porcelain pavers requires the bedding course sand to be pre-compacted and then struck off with a screed to the required thickness as shown in the detail drawings. The porcelain pavers are not compacted and therefore the sand layer beneath them requires pre-compaction. Do not compact dry sand, but insure the sand has a 5 to 6% moisture content so that it will compact cohesively and allow for a smooth strike off finish.

### INSTALLATION INFORMATION THAT MUST BE FOLLOWED :

- Weather, soil type and job conditions should be considered when choosing the best installation method.
- When installing porcelain planks (12 x 48, 8 x 48) always lay the pattern of 1/3's. These should not be placed next to each other at 50%
- NEVER compact porcelain pavers with a plate compactor. Roller compactor recommended for all compaction with porcelain products.
- ALWAYS pre-compact and strike off your sand leveling course before installing your porcelain pavers in sand set installations.
- A proper surface drainage system is required to mitigate standing water. Please consider that Belgard Porcelain Paves are impervious, therefore water must be properly discharged and drained away from the pavement.
- Porcelain pavers should only be wet cut with a tile saw equipped with a wet cut porcelain blade.
- NEVER install porcelain pavers without the required 4mm spacing between them. The porcelain pavers should never be installed with a porcelain to porcelain contact. Plastic 4mm spacers (shown at right) should be used on Sand Set and Permeable installations. The photo on the left illustrates the spacer installed in a perspective to support and space 4 paver corners and the photo on the right illustrates the installed spacer snapped apart (as designed) to form Space T that supports 2 paver corners. This versatility will permit your porcelain pavers to be installed in a stack bond pattern, a running bond pattern as well as a flush installation against another structure.
- For a 100 sf. project, approximately 34 spacers are needed; this allows for overages if needed.

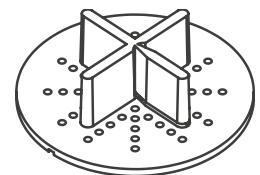

4mm spacers

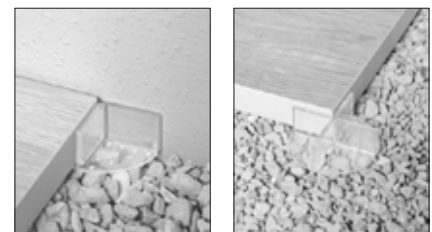







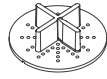

Scan for additional  
product information



Spacers are recommended for all porcelain paver installations.  
PLEASE NOTE: For vehicular applications, must be a mortar install over a concrete slab.  
Please refer to the MIRAGE install guide for driveway install procedure.

PEDESTRIAN	LIGHT/REGULAR TRAFFIC	HEAVY TRAFFIC	PERMEABLE	ADA
				
✓				✓

## SHAPES & SIZES

### 24 x 24



23.54 x 23.54 x 3/4

UNIT	GROSS WEIGHT/ BOX	PIECES/ BOX	SQFT/ BOX	BOXES/ PALLET	SQFT/ PALLET	GROSS WEIGHT/ PALLET
<b>24 X 24</b>						
<b>23.54 X 23.54 X 3/4</b>	76	2	7.75	30	232.5	2280







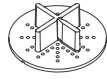

Scan for additional  
product information



Spacers are recommended for all porcelain paver installations.  
PLEASE NOTE: For vehicular applications, must be a mortar install over a concrete slab.  
Please refer to the MIRAGE install guide for driveway install procedure.

PEDESTRIAN	LIGHT/REGULAR TRAFFIC	HEAVY TRAFFIC	PERMEABLE	ADA
				
✓				✓

## SHAPES & SIZES

### 24 x 48



23.54 x 47.17 x 3/4





UNIT	GROSS WEIGHT/ BOX	PIECES/ BOX	SQFT/ BOX	BOXES/ PALLET	SQFT/ PALLET	GROSS WEIGHT/ PALLET
<b>24 X 48</b>						
<b>23.54 X 47.17 X 3/4</b>	<b>74</b>	<b>1</b>	<b>7.75</b>	<b>35</b>	<b>271.25</b>	<b>2621</b>

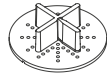

Scan for additional product information



Spacers are recommended for all porcelain paver installations.  
PLEASE NOTE: For vehicular applications, must be a mortar install over a concrete slab.  
Please refer to the MIRAGE install guide for driveway install procedure.

PEDESTRIAN	LIGHT/REGULAR TRAFFIC	HEAVY TRAFFIC	PERMEABLE	ADA
				
✓				✓

## SHAPES & SIZES

### 8 x 48



7.64 x 47.17 x 3/4

### 12 x 48



11.73 x 47.17 x 3/4

### Unico

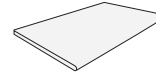

12.99 x 23.54 x 3/4

UNIT	GROSS WEIGHT/ BOX	PIECES/ BOX	SQFT/ BOX	BOXES/ PALLET	SQFT/ PALLET	GROSS WEIGHT/ PALLET
<b>8 X 48</b>						
7.64 X 47.17 X 3/4	46	2	5.06	30	151.8	1380
<b>12 X 48</b>						
11.73 X 47.17 X 3/4	74	2	7.75	36	279	2664

# QUARZITI 2.0





PORCELAIN COLLECTION 

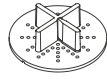

Scan for additional product information



Spacers are recommended for all porcelain paver installations.  
PLEASE NOTE: For vehicular applications, must be a mortar install over a concrete slab.  
Please refer to the MIRAGE install guide for driveway install procedure.

PEDESTRIAN	LIGHT/REGULAR TRAFFIC	HEAVY TRAFFIC	PERMEABLE	ADA
				
✓				✓

## SHAPES & SIZES

### 24 x 24

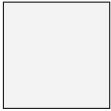

23.54 x 23.54 x 3/4

### 24 x 48



23.54 x 47.17 x 3/4

### Unico

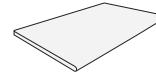

12.99 x 23.54 x 3/4

UNIT	GROSS WEIGHT/ BOX	PIECES/ BOX	SQFT/ BOX	BOXES/ PALLET	SQFT/ PALLET	GROSS WEIGHT/ PALLET
<b>24 X 24</b>						
23.54 X 23.54 X 3/4	76	2	7.75	30	232.5	2280
<b>24 X 48</b>						
23.54 X 47.17 X 3/4	74	1	7.75	35	271.25	2621





**MIRAGE**<sup>®</sup>  
Porcelain.Design.Sustainability

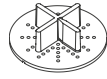

Scan for additional  
product information



Spacers are recommended for all porcelain paver installations.  
PLEASE NOTE: For vehicular applications, must be a mortar install over a concrete slab.  
Please refer to the MIRAGE install guide for driveway install procedure.

PEDESTRIAN	LIGHT/REGULAR TRAFFIC	HEAVY TRAFFIC	PERMEABLE	ADA
				
✓				✓

## SHAPES & SIZES

### 24 x 24



23.54 x 23.54 x 3/4

UNIT	GROSS WEIGHT/ BOX	PIECES/ BOX	SQFT/ BOX	BOXES/ PALLET	SQFT/ PALLET	GROSS WEIGHT/ PALLET
<b>24 X 24</b>						
<b>23.54 X 23.54 X 3/4</b>	<b>76</b>	<b>2</b>	<b>7.75</b>	<b>30</b>	<b>232.5</b>	<b>2280</b>

# UNICO COPING





PORCELAIN COLLECTION 

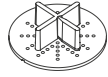

Scan for additional product information



Spacers are recommended for all porcelain paver installations.  
PLEASE NOTE: For vehicular applications, must be a mortar install over a concrete slab.  
Please refer to the MIRAGE install guide for driveway install procedure.

RESIDENTIAL	COMMERCIAL	STEPS	CAPS	COPING
				
✓		✓		✓

## SHAPES & SIZES

### Unico

Only available in Glocal, Quarziti & Noon.

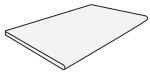

12.99 x 23.54 x 3/4"

UNIT	GROSS WEIGHT/ BOX	PIECES/ BOX	LN FT/ BOX	BOXES/ PALLET	PIECES/ PALLET	GROSS WEIGHT/ PALLET
<b>UNICO</b>						
<b>12.99 X 23.54 X 3/4"</b>	<b>52</b>	<b>3</b>	<b>6</b>	<b>40</b>	<b>120</b>	<b>2080</b>

Two installation needs, a single solution. UNICO, size 12.99"x 23.51"x 3/4", is processed on both sides, on one side it has a rounded edge and on the other a square edge.

An extremely versatile special piece, which can be used both as a step and as a special piece for swimming pools, with bullnose edge or straight edge, both colored along the side.

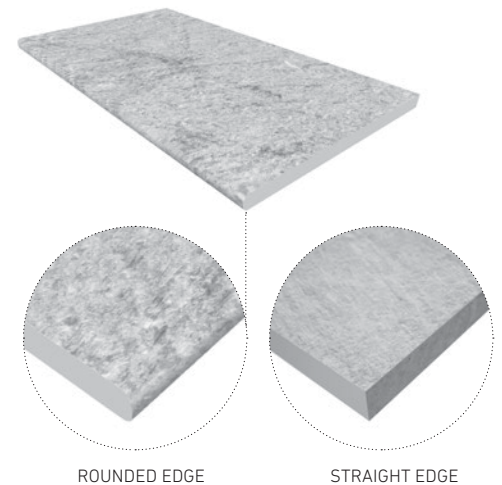

ROUNDED EDGE

STRAIGHT EDGE

# WALLS

## WALL INSTALLATION GUIDE

- 47 Wall Types
- 48 Before You Begin

## WALLS

- 66 Diamond® 9D
- 67 Diamond Pro® Straight, Beveled & Smooth Face
- 69 Diamond Pro Stone Cut®
- 71 Easton Stone™
- 72 Highland Stone®
- 74 Melville™ Wall
- 75 Sterling® Wall
- 76 Ashlar Tandem™
- 76 Lamina Tandem™
- 76 Melville Tandem™
- 78 Versa-Lok® Standard
- 79 Wellington Wall®
- 80 Weston Stone 3-Piece & Universal

For basic wall installation information  
visit [ncma.org](http://ncma.org)



*NCMA Segmental  
Retaining Wall  
Installation Guide*



*NCMA Segmental  
Retaining Walls:  
Residential Applications*

# SEGMENTAL RETAINING WALL TYPES

Segmental retaining walls typically fall into one of three categories.

## GRAVITY RETAINING WALL

The first category — a gravity wall — is a retaining wall that does not use soil reinforcement. A gravity wall has height limitations specific to each product and project. An advantage of this type of retaining wall is that it requires a smaller work area behind the wall. A gravity wall relies on the weight, depth and setback of the block to resist the soil forces being exerted on the wall.

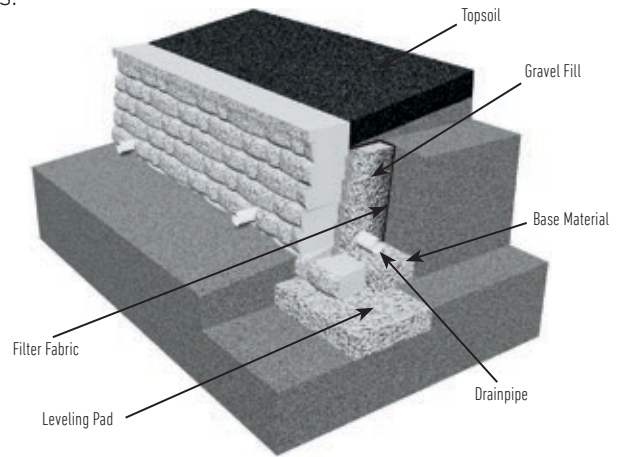

## GEOSYNTHETIC-REINFORCED RETAINING WALL

The second category is a geosynthetic-reinforced wall, which needs to be designed by a qualified engineer. There are (theoretically) no height limitations with reinforced retaining walls, and they are used in larger applications. It requires more work area behind the structure.

The block of soil is stabilized by introducing reinforcement layers into the soil mass behind the facing units. The larger the stabilized soil mass, the more soil can be retained or held back. The geogrid in the soil extends past the theoretical failure plane and serves to create a large, coherent gravity mass of block, geogrid, and soil, to resist the forces exerted by the retained soil.

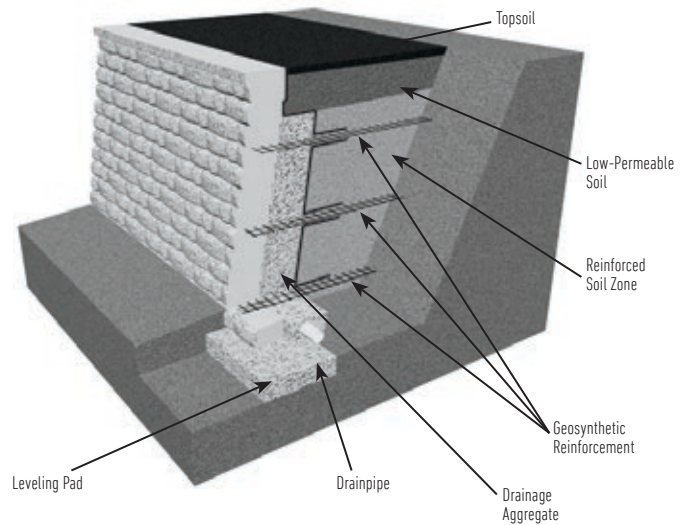

## ANCHORPLEX® SYSTEM

The third category is the Anchorplex system, which offers a unique, non-conventional solution to problematic wall construction sites. It is a retaining wall built with Oldcastle™ products and structural backfill specified by ANCHOR Diamond®, and backed by engineering support tools developed by ANCHOR Diamond.

Use of the Anchorplex system eliminates the need for the geogrid and requires substantially less excavation that is usually necessary in geosynthetic-reinforced wall construction.

Contact ANCHOR Diamond at 1-877-295-5415 for more information about designing and building with the Anchorplex system.

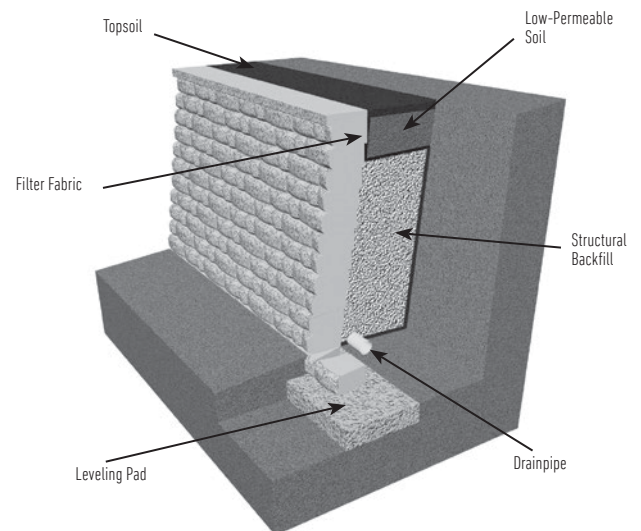



## BEFORE YOU BEGIN

Advance planning and careful layout at the job site help ensure a successful retaining and freestanding wall project.

- Review the site plan to confirm lot lines, wall location, length and elevations.
- Understand on-site soils. Ideal soils are sand and gravel. For walls built in clay or poor soils, work with a local engineer to confirm the wall design and the required soil reinforcement. Black or organic soils should not be used as backfill.
- Confirm the location of underground utilities. Call 811.
- Seek all necessary building permits.
- Prepare a drawing of the site with the wall location, lengths and elevations.
- Plan drainage to avoid erosion or buildup of water behind the wall. Consider where the water will drain through the wall, where downspouts will expel and whether there's an underground sprinkler. For walls greater than three feet in height, a perforated drainpipe is recommended at the base of the aggregate to quickly remove large amounts of water.
- A best practice is to divert water away from the wall before it has an opportunity to enter the reinforced soil and gravel fill zone.
- Check the block delivered to ensure it is the correct product and color. Check the geogrids to confirm that it's the strength and weight specified in the engineering plans.
- Be sure to use the right tools. Hand tools include a shovel, 4-foot level, dead-blow hammer, 2- or 3-pound hammer, chisel, hand tamper, hydraulic splitter and string line. Power tools may include a circular saw with a diamond blade and a plate compactor.
- Always wear protective eye wear.

For additional wall installation references go to [Belgard.com](http://Belgard.com).





# BASIC INSTALLATION CONSTRUCTION GUIDE - RETAINING WALL

## STAKE OUT THE WALL

- Have a surveyor stake out the wall's placement. Verify the locations with the project supervisor.

## EXCAVATION

- Excavate for the leveling pad according to the lines and grades shown on the approved plans and excavate enough soil behind the wall for the geogrids material, if needed.
- The trench for the leveling pad should be at least 12 inches wider than the block you are installing and 6 inches below the bottom of the block. *See Diagram 1.*

## LEVELING PAD

- An aggregate leveling pad is made of compactable base material of  $\frac{3}{4}$ -inch minus (with fines).
- The pad must extend at least 6 inches in front of and behind the first course of block and be at least 6 inches deep after compaction.
- If the planned grade along the wall front will change elevation, the leveling pad may be stepped up in increments of the block height to match the grade change. Start at the lowest level and work upward whenever possible.
- Compact the aggregate and make sure it's level front to back and side to side. *See Diagram 2.*

## BASE COURSE

- This is the most important step in the installation process. Bury the base course of block a minimum of 6 inches or as shown on the plans.
- Begin laying block at the lowest elevation of the wall. Remove the rear lip (if applicable) of the block by hitting from the back so that it will lie flat on the leveling pad. *See Diagram 3.*
- Place first block and level, front to back and side to side; lay subsequent blocks in the same manner.
- Place the blocks side by side, flush against each other, and make sure they are in full contact with the leveling pad.
- If the wall is on an incline, don't slope the blocks; step them up so they remain consistently level.
- Use string line along the back edge of block to check for proper alignment.
- For multi-piece products, use the largest unit, 18 inches wide, for the base course.
- Fill cores (if applicable) and voids between blocks with  $\frac{3}{4}$ -inch free-draining aggregate prior to laying the next course of block. Clean any debris off the top of the blocks. *See Diagram 4.*
- Install any location devices, such as pins, prior to placing the second course of blocks."
- Install any location devices, such as pins, prior to placing the second course of blocks."

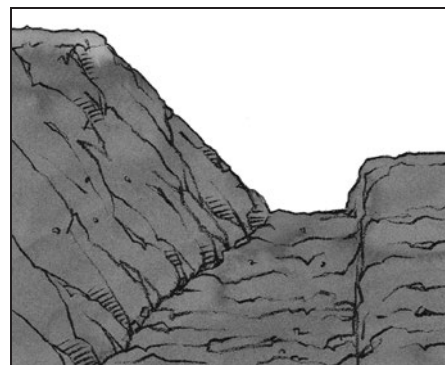

Diagram 1 – Excavation

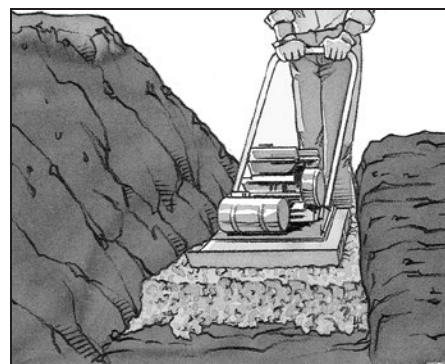

Diagram 2 – Leveling Pad



Diagram 3 – Base Course

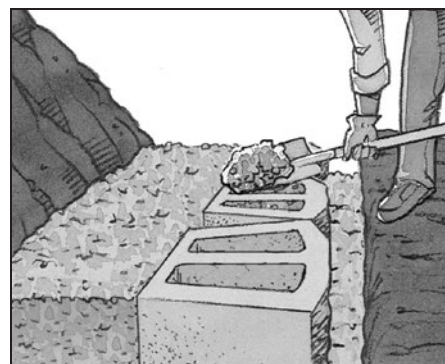

Diagram 4 – Core Fill

## CONSTRUCTION OF SUBSEQUENT COURSES

- Clean any debris off the top of the blocks.
- Place the second course of blocks on top of the base course. Maintain running bond. Pull each block forward as far as possible to ensure the correct setback. *See Diagram 5.*
- Fill cores (if applicable) and voids between blocks with  $\frac{3}{4}$ -inch free-draining aggregate prior to laying the next course of block. Clean any debris off the top of the blocks.
- Backfill with  $\frac{3}{4}$ -inch free-draining aggregate directly behind the block, adding 6 inches at a time followed by proper compaction. Fill thickness will be dependent on compaction equipment
- Add retained soil behind the aggregate. Compact before the next course is laid.
- Don't drive heavy equipment near the wall. Self-propelled compaction equipment should not be used within 3 feet from the back of the wall
- Keep the wall bond by placing units in a staggered relationship to the course beneath.
- You may need partial units to stay on bond. A saw with a diamond blade is recommended for cutting partial units. Use safety glasses and other protective equipment when cutting.

## DRAINAGE DESIGN

- Each project is unique. The grades on your site will determine at what level to install the drainpipe.
- Place the drainpipe as low as possible behind the wall so water drains down and away from the wall into a storm drain or to an area lower than the wall. *See Diagram 6.*
- Fill in the area behind the blocks with  $\frac{3}{4}$ -inch free-draining aggregate, at a minimum of 12-inches from behind the back of the block or 24-inches from the front of the block, whichever is greater.
- You may need to place and backfill several courses to achieve the proper drainage level. *See Diagrams 7 and 8.*
- The drainpipe outlets should be spaced not more than every 50 feet and at low points of the wall. In order for the gravel fill to function properly, it must keep clear of regular soil fill. See below diagram of daylight drainage system.



Diagram 5 – Next Course Construction

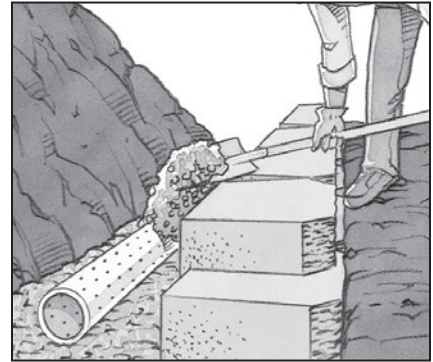

Diagram 6 – Drainage

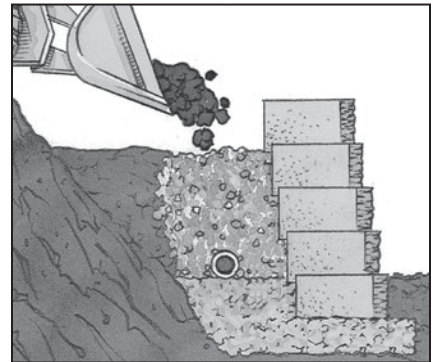

Diagram 7 – Backfill

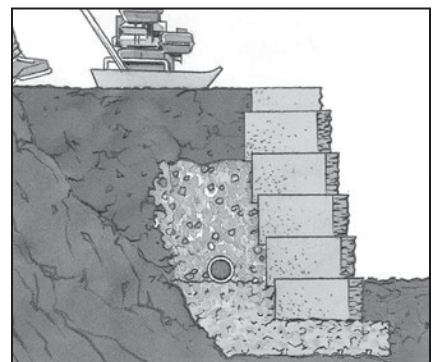
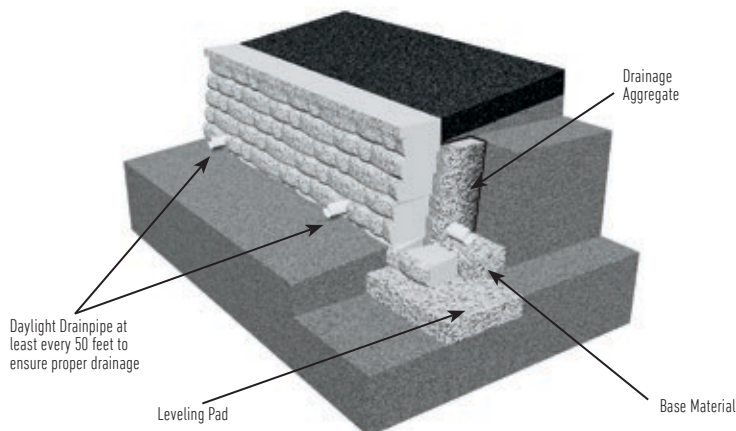

Diagram 8 – Compaction



## STEPPING UP THE BASE AT LOWEST POINT

Walls built on a sloping grade require a stepped base. Begin excavation at the lowest point and dig a level trench into the slope until it is deep enough to accommodate the base material and the height of two entire blocks. A minimum embedment of 6 inches is required at all times.

### STEP-UP

At this point, step up the height of one block and begin a new section of base trench. Continue to step up as needed to top of slope. Always bury at least one full unit at each step, maintaining a minimum embedment of 6 inches at all times.

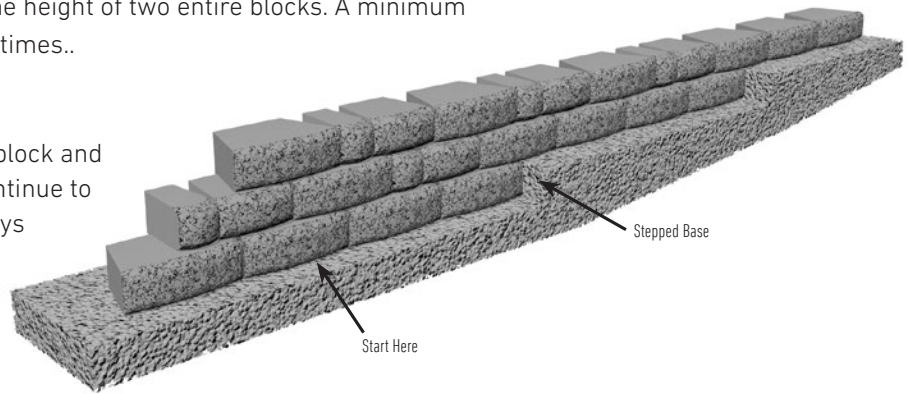

## STEPPING UP THE BASE USING THE U START BASE BLOCK

Walls built on a sloping grade require a stepped base. Begin excavation at the lowest point and dig a level trench, 24 inches wide, into the slope until it is deep enough to accommodate the base material, the base block and enough depth to maintain a minimum of 6 inches of embedment after stepping up.

See Diagram 9.



Diagram 9 – Drainage

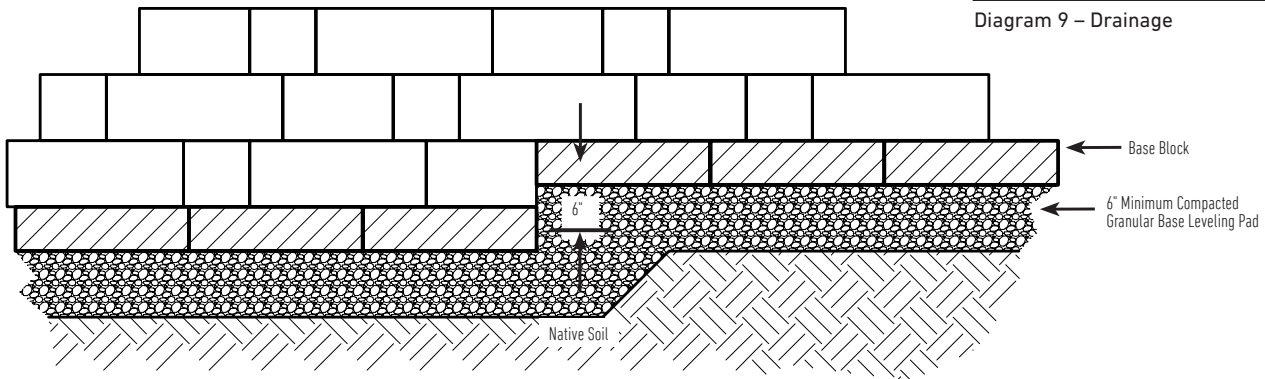

## XL™ CAP

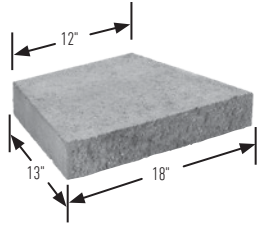

## STRAIGHT WALL

The XL™ cap must be laid alternately, short and long faces for a straight line. Always start capping from the lowest elevation. Once caps are aligned, caps should be glued in place using a concrete adhesive.

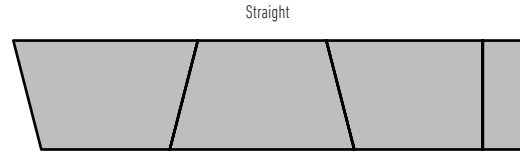

## CURVES

Lay out the cap units side by side with the same face facing out (long faces for outside curves; short face to inside curves). If there's a need to adjust for project's radius, make cuts at least every other cap as needed for the most pleasing aesthetic.

- Minimum radius with XL™ cap: 2 feet 2 inches

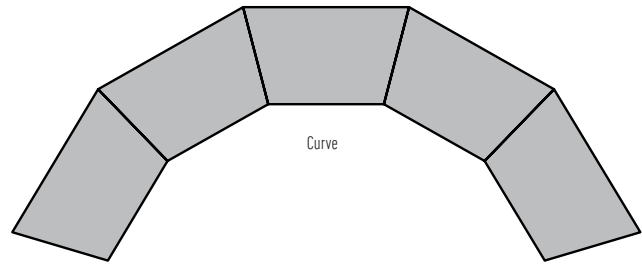

## 90-DEGREE CORNERS

Saw-cut two caps to achieve a 45-degree mitered corner.

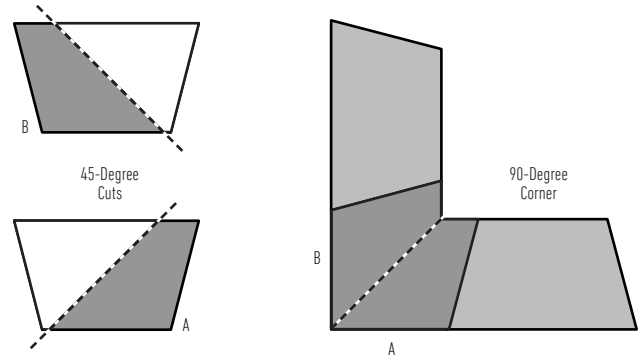

## STEPPING UP CAPS WITH XL™ CAP

If the wall elevation changes, caps can be stacked where the wall steps up. Begin laying caps at the lowest elevation change and work your way toward the next step up. Split\* a cap unit to fit. Place the split unit directly on top of the capped portion of the wall with all three split faces exposed.

## FINISHING WITH XL™ CAP

After layout is complete and caps are saw-cut or split to size, carefully place concrete adhesive on wall top course and then place caps.

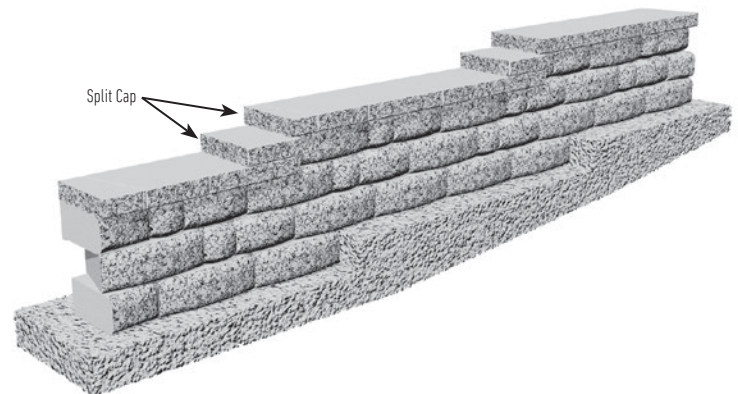

**\*NOTE:** To split a block, use a hydraulic splitter or split manually by using a hammer and chisel to score the block on all sides. Pound the chisel on the same line until the block splits. If partial unit sides are not exposed, use a saw with a diamond blade to achieve a tighter fit.



## GEOSYNTHETIC REINFORCEMENT (IF REQUIRED)

- Geosynthetic reinforcement is recommended for walls taller than the gravity height determined for the project, or walls situated in poor soils, supporting a driveway, etc. Consult an engineer for design assistance.
- Check the wall construction plan for which courses will need geogrids.
- Clean any debris off the top layer of blocks.
- Measure and cut the geogrids to the design length in the plans.
- Many geosynthetic reinforcements have a design strength direction, which must be laid perpendicular to the wall.
- Place the front edge of the geogrids on top of the block, making sure it's within 1 inch of the face of the block. Correct placement ensures that you maximize the connection strength and keep the batter consistent.
- Apply the next course of blocks to secure it in place.
- A minimum of 6 inches of backfill is required prior to operating vehicles on the geogrids. Avoid sudden turning or braking.

## COMPACTION

- Place the backfill soil behind the drainage aggregate and compact to 95% standard PROCTOR density with a hand-operated compactor.
- Make sure the aggregate is level with or slightly below the top of the course.
- Place soil in front of the base course and compact. The base course should be buried.
- Continue to fill and compact.

## FINISH GRADE AND SURFACE DRAINAGE

- Protect the wall with a finished grade at the top and bottom.
- To ensure proper water drainage away from the wall, use 8 inches of soil with low permeability. This will minimize water seeping into the soil and gravel fill behind the wall. *See Drainage Swales.*

## SITE CLEANING AND RESTORATION

- Brush off the wall and pick up any debris left from the construction process.
- Notify the job superintendent in writing of the project's completion and that it is ready for final inspection and acceptance.
- Planting vegetation in front and on top of the wall will help reduce the chance of erosion.
- Following the best practices for construction will ensure the successful installation of Anchor™ products.

## DRAINAGE SWALES

- Design and performance of most retaining walls are based on keeping the reinforced zone relatively dry. Appropriate drainage swales to help control water should be designed into the wall construction plan.

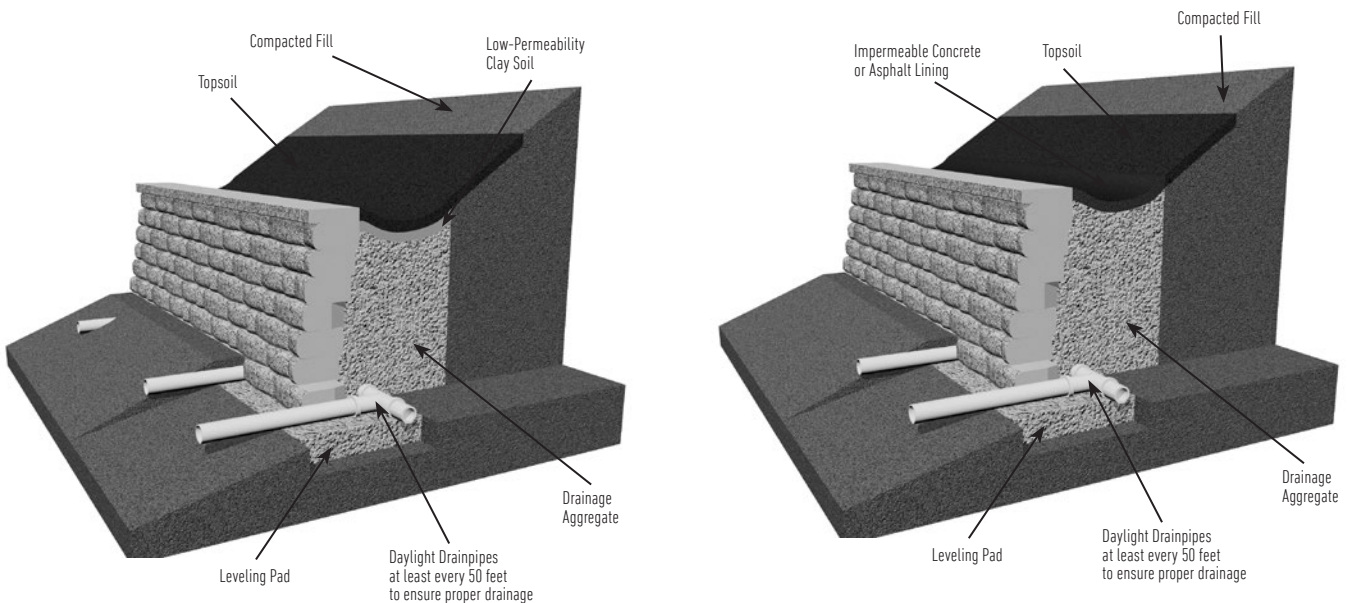

**SAFETY NOTE:** Always use appropriate equipment, including safety glasses or goggles and respirators, when splitting, cutting or hammering units. Refer to the NCMA Segmental Retaining Wall Installation Guide at [www.ncma.org](http://www.ncma.org).

# ABUTTING AN EXISTING STRUCTURE

## FIRST COURSE

Begin with the first block next to the wall and place the first course. Place filter fabric behind the first two units and extend it 2 feet along the existing structure.

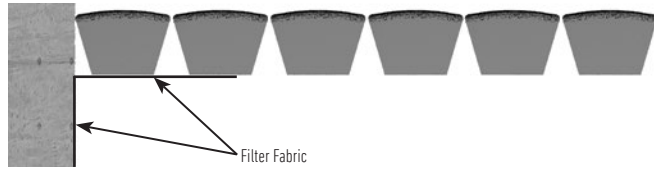

First Course

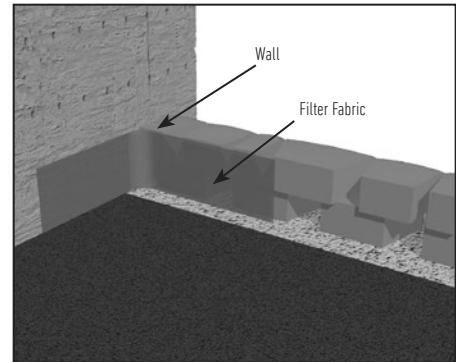
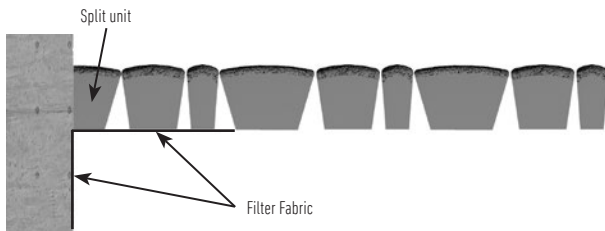

Diagram 10 – Extend Filter Fabric

## SECOND COURSE

Build second course with standard installation techniques. A split unit is shown but may not be necessary in every installation. Extend filter fabric to the top edge of the final course. *See Diagram 10.* A rubber membrane may be placed between the units and a non-concrete wall to prevent moisture damage to the structure.



Second Course

**Note:** To split a block, use a hydraulic splitter or split manually by using a hammer and chisel to score the block on all sides. Pound the chisel on the same line until the block splits. If partial unit sides are not exposed, use a saw with a diamond blade to achieve a tighter fit.

# OUTSIDE CURVES

## CALCULATE THE RADIUS

When building an outside curve, begin by determining the desired radius of the top course. This will be the smallest radius in the wall and must not be less than the minimum radius for the wall system used.

To determine the approximate base course radius:

- 1) Add ¼-inch to the setback of the block used. Multiply that by the number of courses in the finished wall.
- 2) Add desired radius length of the top course to the result of step 1. This number equals the approximate radius length of the base course.
- 3) To determine the radius for the front edge of the trench, add 6 inches to the approximate radius length of the base course.

Example: Setback of the Highland Stone® product is 1⅛-inch. The wall is 8 courses high. The desired radius of the wall measured to the front of the block on the top course is 6 feet.

- 1) Setback multiplied by number of courses  
 $1\frac{1}{8}'' + \frac{1}{4}'' = 1\frac{3}{8}'' \times 8 \text{ courses} = 11''$
- 2) Desired radius plus setback  
 $6' + 11'' = 6'11''$
- 3) Front of trench  
 $6'11'' + 6'' = 7'5''$

**TIP:** Subtract the depth of the block if you prefer to mark the curve from the back of the block.

## LAY OUT THE TRENCH

Drive a stake into the ground at the desired radius point of the curve. Attach a string and rotate it in an arc at the desired length to mark the curve in the soil. Dig the trench.

## BASE COURSE

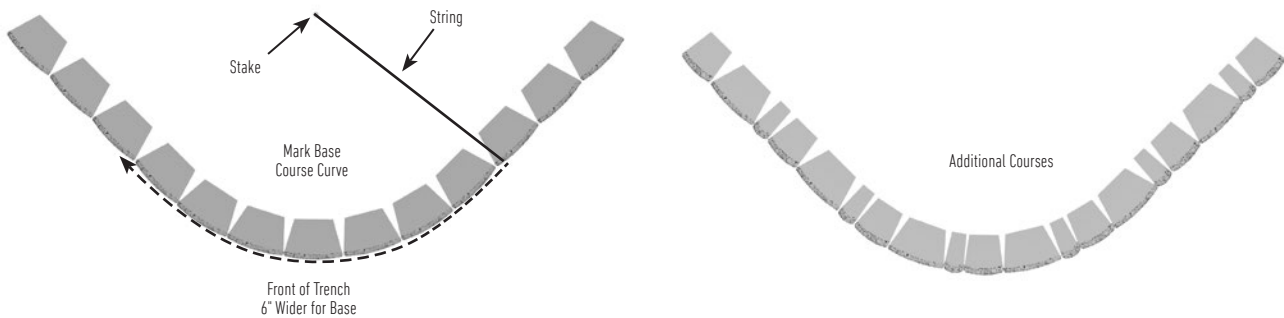

Using the existing radius point stake and string, mark the base course curve on the leveling pad. Align the front of the block with the marked curve and ensure level placement from side to side and front to back.

## ADDITIONAL COURSES

On each course, some of the rear lip of each block must be in contact with the back of the units below to ensure structural stability. The setback of the block will cause the radius of each course to gradually decrease and eventually affect the running bond of the wall. To maintain proper running bond, use partial units as needed. Once a split or cut unit is cut to size, glue in place with a concrete adhesive.

# INSIDE CURVES

## CALCULATE THE RADIUS

Check the wall plan to determine the radius of the top course. This will be the biggest radius in the wall and you will need it to determine the radius at the base course, which will be the smallest radius of the wall and must not be less than the minimum for the block system used.

### A QUICK WAY TO DETERMINE THE BASE COURSE RADIUS:

- 1) Add ¼-inch to the setback of the block used. Multiply that by the number of courses in the finished wall.
- 2) Subtract the result of step 1 from the radius of the top course. This number equals the approximate radius length of the base course.
- 3) To determine the radius for the front edge of the trench, subtract 6 inches from the approximate radius length of the base course.

Example: The setback of the Highland Stone® product is 1⅛-inches. The wall is 8 courses high. The desired radius of the wall measured to the front of the block on the top course is 10 feet.

- 1) Setback multiplied by number of courses  
 $1\frac{1}{8}'' + \frac{1}{4}'' = 1\frac{3}{8}'' \times 8 \text{ courses} = 11''$
- 2) Desired radius minus setback  
 $10' - 11'' = 9'1''$
- 3) Front of trench  
 $9'1'' - 6'' = 8'7''$

**TIP:** Add the depth of the block if you prefer to mark the curve from the back of the block.

## LAY OUT THE TRENCH

Drive a stake into the ground at the desired radius point of the curve. Attach a string and rotate it in an arc at the desired length to mark the curve in the soil. Dig the trench.

## BASE COURSE

Using existing radius point stake and string, mark the base course curve on the leveling pad. Align the front of the block with the marked curve and ensure level placement from side to side and front to back.

## ADDITIONAL COURSES

On each course, some of the lips of each block must be in contact with the back of the units below to ensure structural stability. If not, use construction adhesive to adhere blocks together. To maintain proper running bond, use partial units as needed. Once a split unit is cut to size, glue in place with a concrete adhesive.

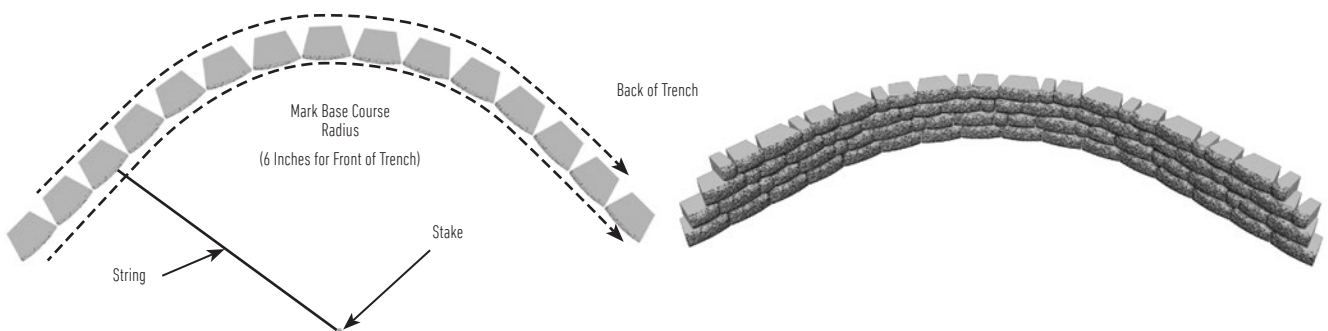



# OUTSIDE 90-DEGREE CORNERS

FOR SYSTEMS WITHOUT A CORNER UNIT

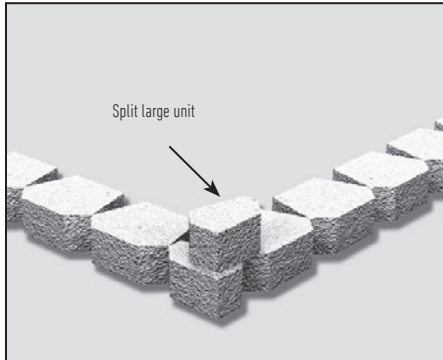

Outside 90-Degree Corner without Corner Unit

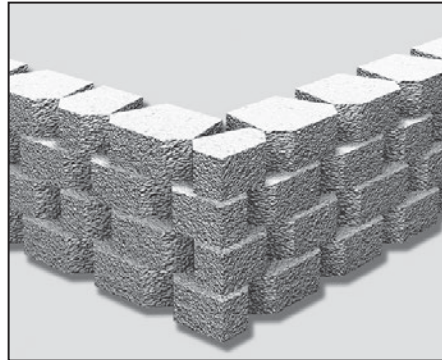

Additional Courses

## BASE COURSE

To build an outside 90-degree corner, begin by splitting a unit in half. Place this unit with both split faces out at the corner. If needed, remove the rear lip so that the block lies flat. Then lay the rest of the base course working from the corner block out.

## ADDITIONAL COURSES

Begin the next course with the other half of the split unit faced in the opposite direction at the corner. Place the second and third blocks on either side of the corner unit. Once the corner unit is in position, glue block in place with a concrete adhesive. Continue to alternate the corner unit orientation with each course and always use a concrete adhesive on the corner units. Use cut or split units as necessary to maintain running bond.

# OUTSIDE 90-DEGREE CORNERS

FOR SYSTEMS WITHOUT A CORNER UNIT

90-degree corners are built by alternating corner/column units so the long side is on different sides of the wall. Build the pattern from the corner unit when possible. Install corner units level from front to back.

Depending on the wall layout, there may be a need to go off the pattern and randomly place wall blocks near the corner. Set back corner units to reflect the batter of the wall block units and glue from bottom to top.



Outside 90-Degree Corner with Corner/Column Unit

**NOTE:** To split a block, use a hydraulic splitter or split manually by using a hammer and chisel to score the block on all sides. Pound the chisel on the same line until the block splits. If partial unit sides are not exposed, use a saw with a diamond blade to achieve a tighter fit.

# INSIDE 90-DEGREE CORNERS

## BASE COURSE

To create an inside 90-degree corner, begin by placing a block at the corner. Then lay a second block perpendicular to the first and continue laying out the rest of the base course working from the corner out. Make sure to construct the base course according to standard site prep and installation procedures.



Example Inside 90-Degree Corner

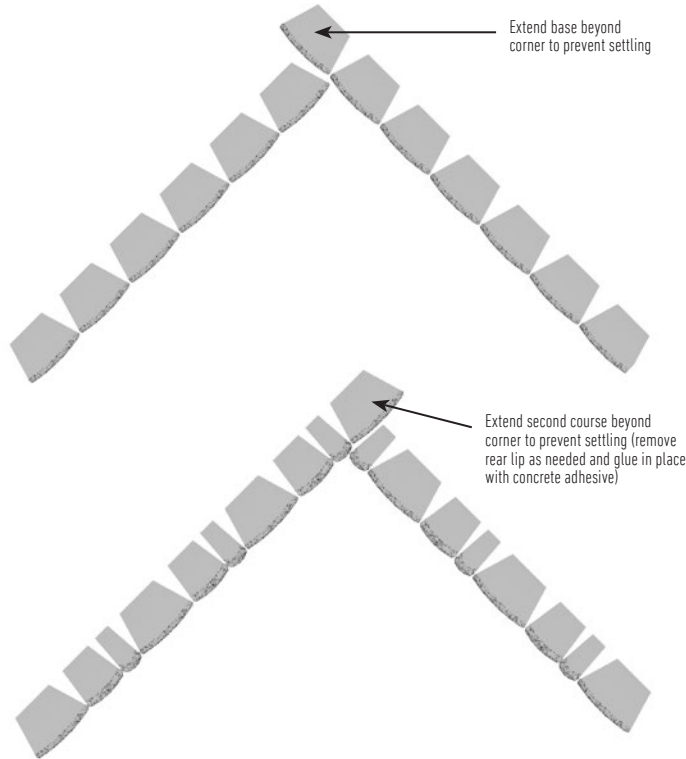

## ADDITIONAL COURSES

On the second course, place all blocks on bond along one side of the corner. Once the second course of one wall is established, begin the second course of the adjacent wall. Split units or units of varying sizes may be required on this wall to maintain running bond. Continue to alternate the corner unit orientation with each course and always use a concrete adhesive on the corner units.

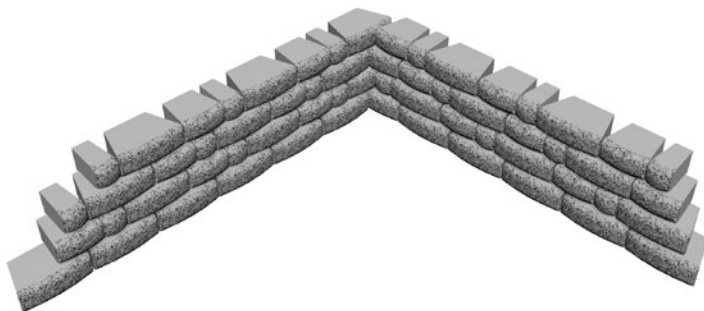

**NOTE:** To split a block, use a hydraulic splitter or split manually by using a hammer and chisel to score the block on all sides. Pound the chisel on the same line until the block splits. If partial unit sides are not exposed, use a saw with a diamond blade to achieve a tighter fit.

## STEPS IN A CURVED WALL

These drawings show Highland Stone®, Diamond® and Diamond Stone Cut® step units. Caps or pavers can be used for treads. Check local building codes for any tread depth standards.



### BASE COURSE

Thoroughly compact the leveling pad. Lay out the base course according to the wall design. Place step units first, working from the center to each side. Remember, it is very important to backfill and compact behind and along the sides of each course of step units.



### FIRST STEP COURSE

Place the first course of step units directly on top of the base course so there is no setback. Stagger them from the previous course and glue in place.



### SECOND STEP COURSE

Add the second course of steps, staggering them from the previous course to maintain running bond. Overlap the lower course by a minimum 2 inches and glue to lower course. Place and compact base material prior to installing next course.

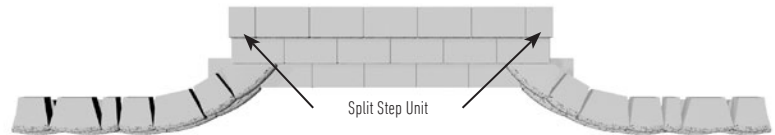

### NEXT WALL COURSE

Place a block near the second course of steps, maintaining running bond with the base course. Measure and cut a block to fit the space remaining between the step unit and the next course of the wall. Place the unit in the wall, making sure that both vertical edges fit tight against both the step and standard unit. Remove the rear lip on the blocks when necessary, and angle the blocks flush with the face of the previous course. Glue in place with a concrete adhesive. Repeat these steps until the wall is finished.

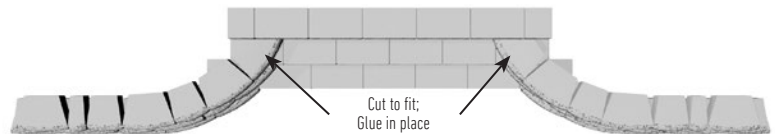

### ADDITIONAL COURSES

Beginning in the center, add the third course of steps, lining up the units with the first course. Overlap a minimum 2 inches and glue in place. Repeat until the steps are finished.

**DRAINAGE TIP:** Drain pipe can be placed behind the lowest step units at grade or behind each wall adjacent to the steps.

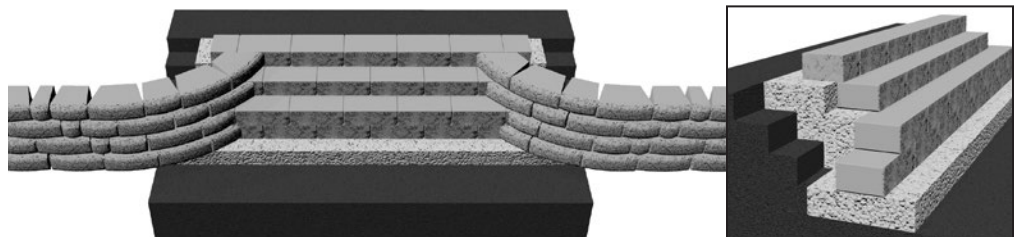

## STEPS IN A 90-DEGREE WALL

These drawings show Highland Stone®, Diamond® and Diamond Stone Cut® step units. Caps or pavers can be used for treads. Check local building codes for any tread depth standards.



### BASE COURSE

Thoroughly compact the leveling pad. Lay out the base course according to the wall design. Place step units first, working from the center to each side. Remember, it is very important to backfill and compact behind and along the sides of each course of step units.



### FIRST STEP COURSE

Place the first course of step units directly on top of the base course so there is no setback. Stagger them from the previous course and glue in place.

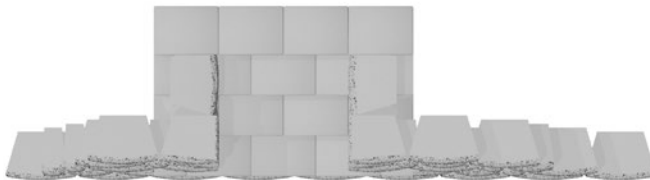

### SECOND STEP COURSE

Add the second course of steps, staggering them from the previous course to maintain running bond. Overlap the lower course by a minimum 2 inches and glue to lower course. Place and compact base material prior to installing next course.

### SECOND WALL COURSE

Build the second course of the wall. Corner units are used at the end of steps tied into wall and glued in place. Alternate long and short direction of corner unit every other row.

### THIRD STEP COURSE

Beginning in the center, add the third course of steps, lining up the units with the first course. Overlap the lower course by 2 inches and glue to lower course.

### ADDITIONAL COURSES

Build the third course of the wall. Repeat these steps until the wall is finished.

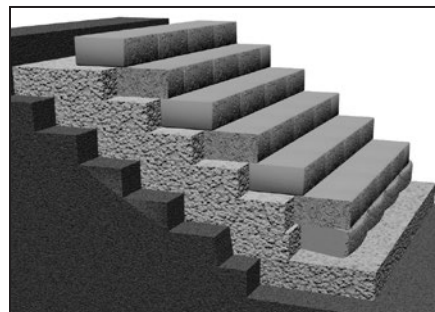
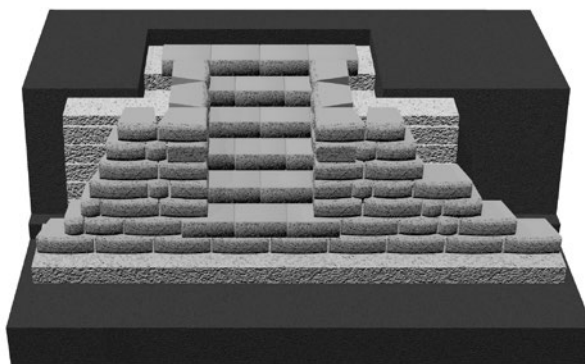

# ANCHORPLEX® SYSTEM CONSTRUCTION GUIDE

## HOW TO USE THIS GUIDE

Use this information to gain a general understanding of the basics of building retaining walls with the Anchorplex system. Do not use this in lieu of construction drawings provided by a qualified engineer. Contact ANCHOR Diamond® at 1-877-295-5415 for more information about designing and building with the Anchorplex system.

## ABOUT THE ANCHORPLEX® SYSTEM

The Anchorplex system is a retaining wall built with Oldcastle™ products and self-compacting structural backfill, also known as “no-fines” concrete, which is a highly-porous mixture of clean stone, cement and water. The mixing ratios (by weight) of aggregate to cementitious material should be between 6:1 and 7:1. The mixing rate (by weight) of water to cementitious material should be no more than 1:2. The resulting material, upon curing, should have at least 25 percent voids.

## RETAINING WALL CONSTRUCTION

Setting out the wall and excavation is no different for an Anchorplex system construction than for conventional construction, except that the amount of excavation will probably differ. Construction of the leveling pad, base course, subsequent courses and drainage is no different for an Anchorplex system construction than for conventional construction.

## INSTALLATION OF STRUCTURAL BACKFILL

After completion of the leveling pad, base course, drainpipe installation and stacking block 2 feet above grade, the first lift of structural backfill that meets Anchor Wall Systems' specifications can be installed. Do not exceed 2 feet vertical stacking of block before placing a lift of structural backfill

The structural backfill can be placed directly from delivery vehicle or with skid-type loader or other equipment. It should be placed behind the blocks and worked into all voids and cores of the blocks (if applicable). When properly formulated, the structural backfill will not leak through the face of the wall.

After installation of the first lift of structural backfill, install additional courses and repeat the process. Place additional lifts every 8 to 24 inches depending on site conditions and project scale. Subsequent pours can be made as soon as the structural backfill in the previous lift has set — usually within 2 to 3 hours.

## INSTALLATION OF FILTER FABRIC

Place a layer of filter fabric over the structural backfill and up the back of the top course and the cap. Then fill behind the top course and cap with low-permeability soil.

## CAPPING & FINISHING

Follow standard practice when capping the wall. Protect the wall with a finish grade at the top and bottom.

## EXAMPLE: 6" MULTI-PIECE RETAINING WALL SYSTEM USING THE ANCHORPLEX SYSTEM

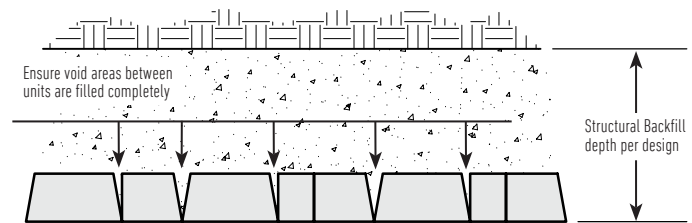
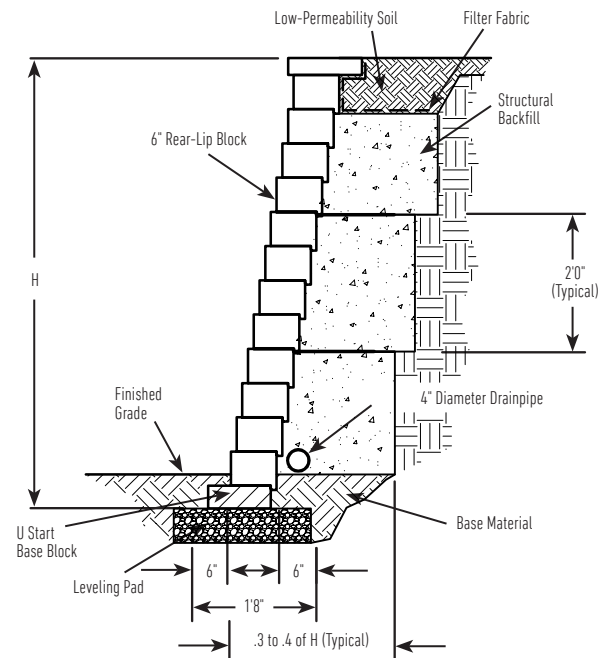

# LAYING PATTERN GUIDE FOR MULTI-PIECE WALLS

## USING A PATTERN FOR SINGLE-HEIGHT RETAINING WALLS

When using a pattern, begin at one edge, laying the units as indicated. Install at least one repeat of the pattern to establish the pattern before proceeding to the next course. Stagger the patterns as shown to avoid vertical bonds.

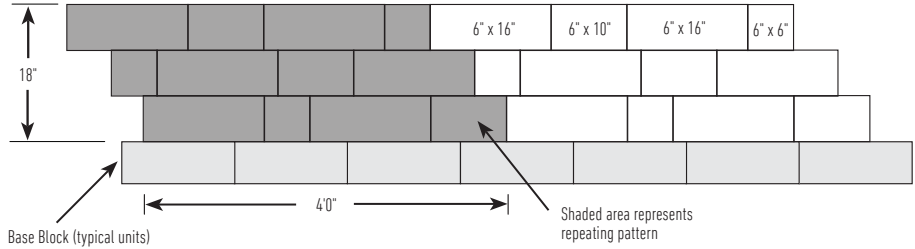

One set of 6-inch-high retaining wall blocks consists of 2 large units, 1 medium unit and 1 small unit, and is 2 square feet.

6" Multipiece wall system, 18-inch by 4-foot pattern = 6 sq. ft.

Blocks required		Blocks required	
12	6" x 16"	6	6" x 16"
6	6" x 10"	3	6" x 10"
6	6" x 6"	3	6" x 6"

## USING A PATTERN FOR FREESTANDING WALLS

One set of 6-inch-high blocks consists of 2 large units, 1 medium unit and 1 small unit, and is 1 square foot of two sided wall.

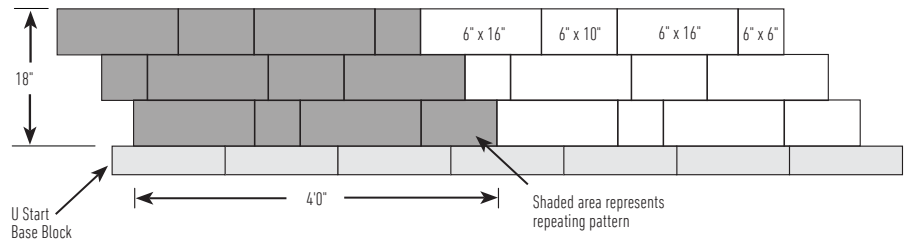

Note: These freestanding wall installation patterns show only one side of the freestanding wall. The same number of blocks are needed to build the other side of a freestanding wall when using Belair Wall 2.0 and Brisa freestanding wall systems. Freestanding wall installation patterns are measured in length by height of one side of the wall, and are expressed in square feet. Sets of blocks required include the number of blocks needed to build both sides of the wall.

## ENDING A WALL WITH WALL ENDS

Start pattern next to a wall end unit if the wall does not end with a column. Every other wall end is cut in half. Glue all pieces in place using concrete adhesive.

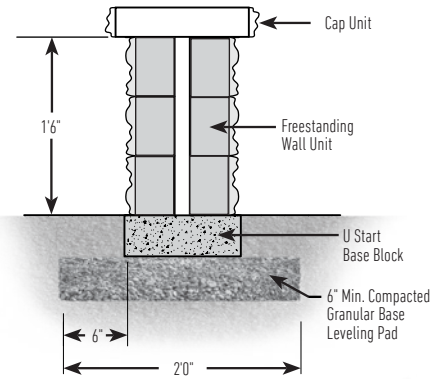

TYPICAL CROSS SECTION

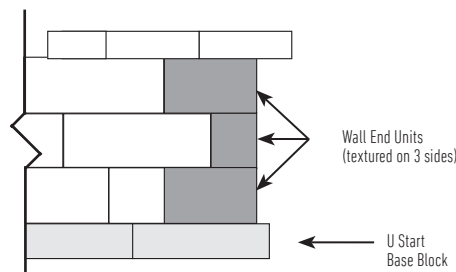



## COLUMN CONSTRUCTION

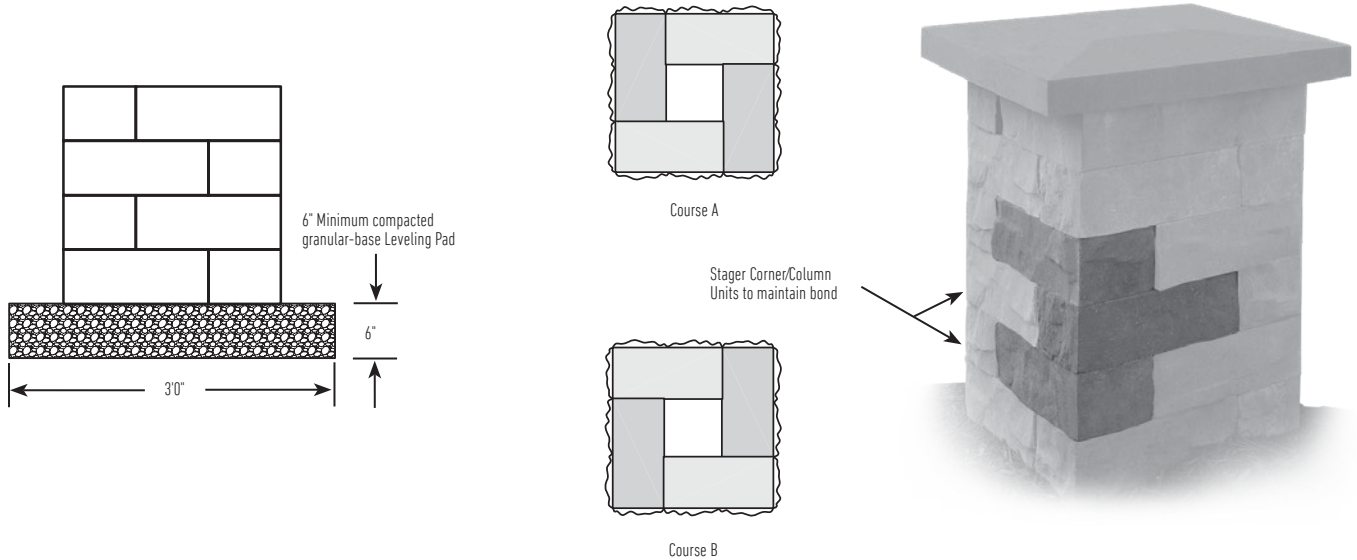

## STEPPING UP THE BASE AT LOWEST POINT

Walls built on a sloping grade require a stepped base. Begin excavation at the lowest point and dig a level trench into the slope until it is deep enough to accommodate the base material and height of one entire block.

### STEP-UP

At this point, step up the height of one block and begin a new section of base trench. Continue to step up as needed to top of slope. Always bury at least one full unit at each step.

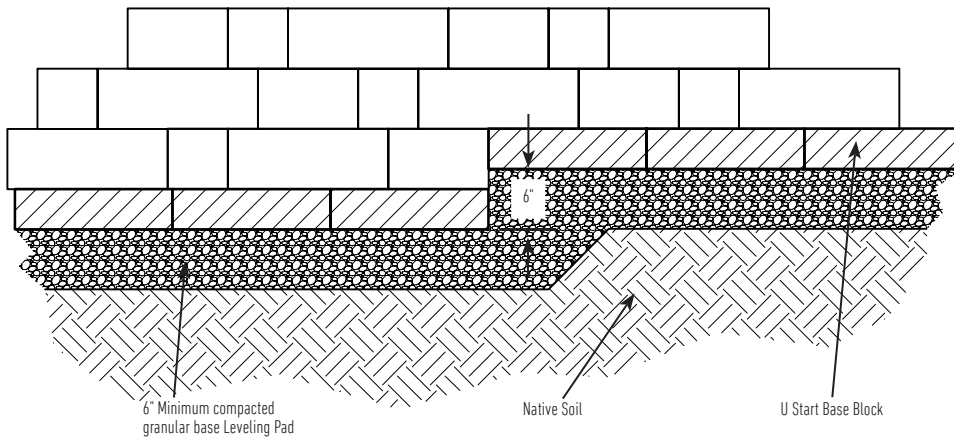



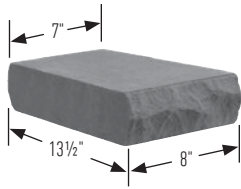

### TRAPEZOID DOUBLE-SIDED CAP

The double-sided cap has a right-angle side and an offset-angle side. The caps can be used in any of four directions since there is no specific top or bottom.

### STRAIGHT WALL

The cap must be laid alternately, narrow (N) and wide (W) faces, for a straight line. Always start capping from the lowest elevation.

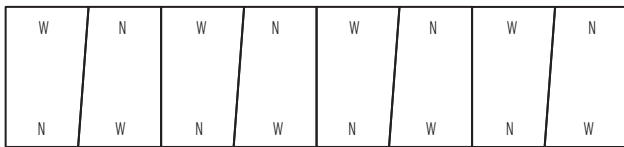

### CURVES

Lay out the cap units side by side with same face facing out (wide faces for outside curves; narrow faces for inside curves). Occasional cutting of some pieces may be necessary.

Minimum radius: 7'6"

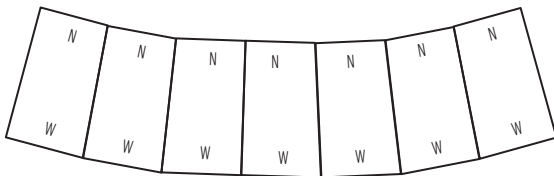

### 90-DEGREE CORNERS WITH CAP END

Using a Cap End unit.

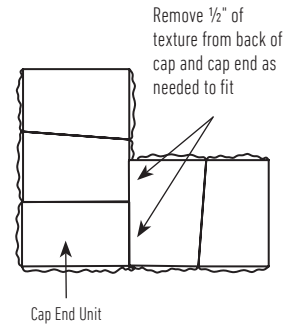
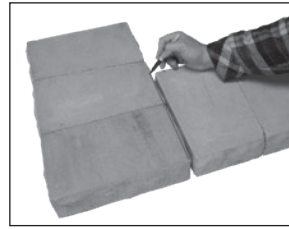

### FINISH WITH A CAP END

Do not cut the cap end, cut an interior cap if needed.

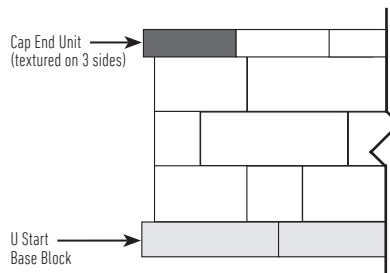

### STEPPING UP CAPS WITH CAP ENDS

If a wall elevation changes, caps can be stacked where the wall steps up. Begin laying caps at the lowest elevation and work your way toward the next step-up. Cut a cap unit to fit. Place the cut unit directly on top of the capped portion of the wall with the cut side hidden from view. If not using a Cap End, place the trapezoid double-sided cap so that the side with the arrow is hidden.

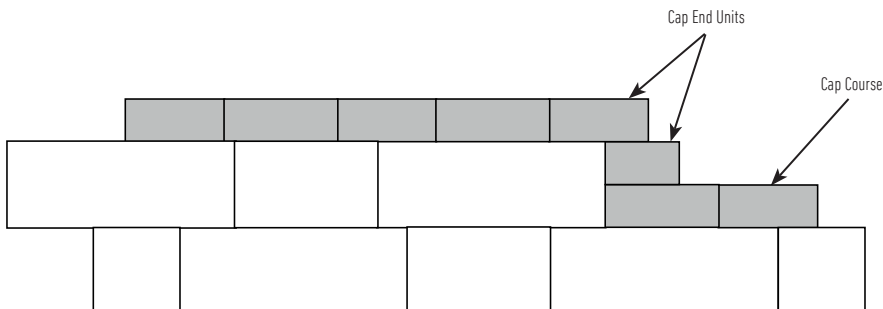

**NOTE:** To split a block, use a hydraulic splitter or split manually by using a hammer and chisel to score the block on all sides. Pound the chisel on the same line until the block splits. If partial unit sides are not exposed, use a saw with a diamond blade to achieve a tighter fit.

## STEP CONSTRUCTION

When constructing steps, you must consider whether it is a fill or a cut-grade situation. Construction is similar, but varies in the amount of dummy units required.

A fill step will have a base course of dummy units in the entire footprint of the steps. For each additional step, add dummy units behind the facing units for stability. There are two methods for creating the step facing. Use sets of either 6-inch-high or 3-inch-high units. A cut-grade set of steps will use one layer of dummy blocks under each step, effectively stepping up the grade.

All applications will require some sort of tread to cover the facing units.

### USING FILL SCENARIO

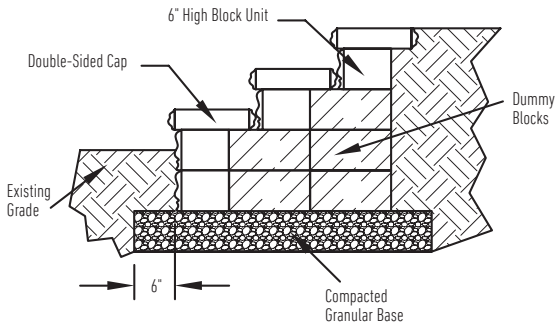

### USING CUT SCENARIO

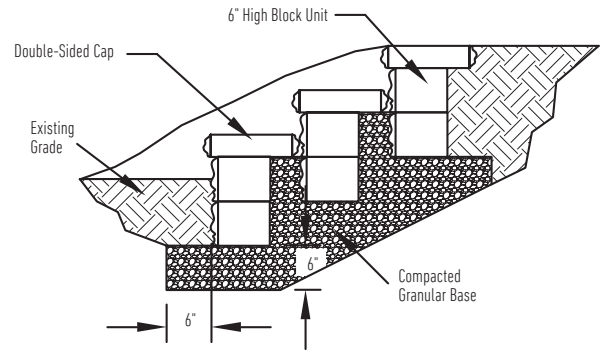

## RETAINING WALL SQUARE FIRE PIT CONSTRUCTION

Inside of fire pit must be lined with a heat-resistant material. Affix all units with construction-grade adhesive.



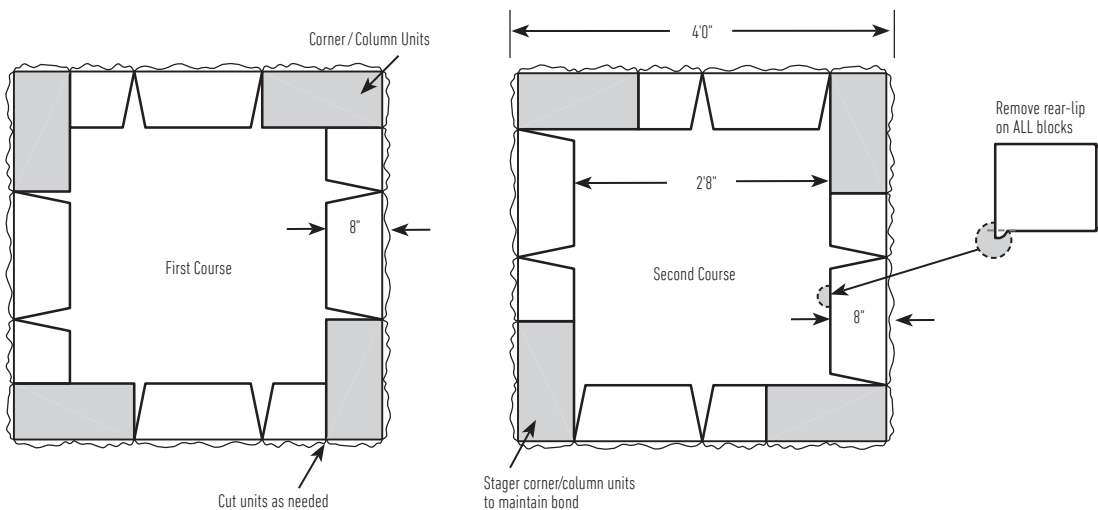
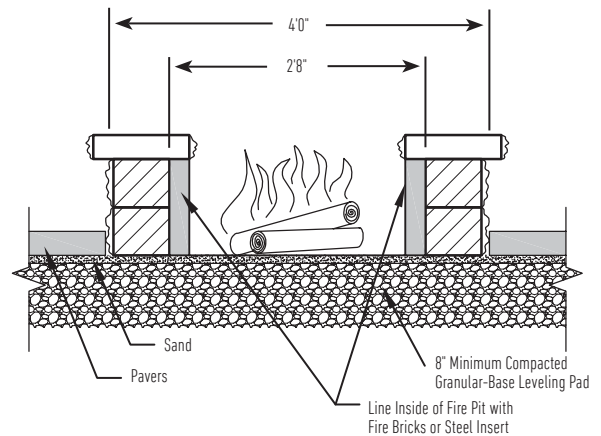





These blocks are not fireproof and could start to crack under extreme heat. These blocks are intended for landscape applications and are not fire-rated. Over time the blocks may crack. A possible solution is to use heavy fire-rated bricks or a steel liner on the interior of an above or below ground fire ring/pit with the blocks outside the perimeter. Again, the heat may adversely affect landscape products, even with an interior heat-resistant barrier in place.



<b>Piece Counts:</b>	
<b>Column/Corner</b>	<b>8</b>
<b>6 x 16 x 8</b>	<b>8</b>
<b>6 x 8 x 8</b>	<b>8</b>



Scan for additional product information

RESIDENTIAL	COMMERCIAL	STEPS	COLUMNS	FIRE PITS	KITCHEN	FREESTANDING WALL	RETAINING WALL
							
✓	✓	✓					✓

## SHAPES & SIZES

### Block

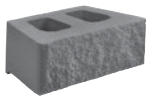

6 x 17<sup>3</sup>/<sub>4</sub> x 9

### Right Virtual Joint



6 x 17<sup>3</sup>/<sub>4</sub> x 9

### Left Virtual Joint



6 x 17<sup>3</sup>/<sub>4</sub> x 9

### Universal Cap



3 x 18 / 12 x 13

### U Start Base Block®



3<sup>1</sup>/<sub>2</sub> x 18<sup>7</sup>/<sub>16</sub> x 12\*

Sold separately. Recommended for use with all available wall block units. Visit [Belgard.com](http://Belgard.com) for full product information.

\*U Start Base Block actual coverage length is 16<sup>11</sup>/<sub>16</sub>

UNIT	SQFT/ PALLET	SQFT/ LAYER	LAYER/ PALLET	UNITS/ PALLET	SQFT/ UNIT	WEIGHT/ UNIT	WEIGHT/ PALLET
------	-----------------	----------------	------------------	------------------	---------------	-----------------	-------------------

### STRAIGHT FACE

6 X 17 <sup>3</sup> / <sub>4</sub> X 9	45	9	5	30 SOLID 15 LEFT VJ 15 RIGHT VJ	0.74	56	3092
--	----	---	---	---------------------------------------	------	----	------

### UNIVERSAL CAP

3 X 18 / 12 X 13	90 LF	11.25 LF	8	72	1.25 LF	54.69	3938
------------------	-------	----------	---	----	---------	-------	------











# DIAMOND PRO®

HERITAGE COLLECTION 

METROPOLITAN COLLECTION 



Scan for additional product information

RESIDENTIAL	COMMERCIAL	STEPS	COLUMNS	FIRE PITS	KITCHEN	FREESTANDING WALL	RETAINING WALL
							
✓	✓	✓	✓				✓

## SHAPES & SIZES

*\*Special Order*

### Diamond Pro Straight Face

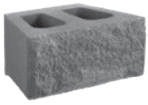

8 x 18 x 12

### Diamond Pro Beveled Face



8 x 18 x 12

### Diamond Pro Corner

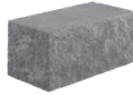

8 x 18 x 9

### Diamond Pro Cap\*

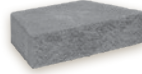

4 x 17¼ / 14 x 10

### Universal Cap



3 x 18 / 12 x 13

### Diamond Pro Smooth Face



8 x 18 x 12

### Diamond Pro Smooth Face Corner



8 x 17 x 8

### Diamond Pro Smooth Face Cap



4 x 18 / 12 x 12

### U Start Base Block®



3½ x 18<sup>7</sup>/<sub>16</sub> x 12\*

*Sold separately. Recommended for use with all available wall block units. Visit [Belgard.com](http://Belgard.com) for full product information.*

*\*U Start Base Block actual coverage length is 16<sup>11</sup>/<sub>16</sub>.*











UNIT	SQFT/ PALLET	SQFT/ LAYER	LAYER/ PALLET	UNITS/ PALLET	SQFT / UNITS	WEIGHT/ UNIT	WEIGHT/ PALLET
<b>DIAMOND PRO STRAIGHT FACE</b>							
8 X 18 X 12	32	8	4	32	1	83	2653
<b>DIAMOND PRO BEVELED FACE</b>							
8 X 18 X 12	32	8	4	32	1	81	2597
<b>DIAMOND PRO CORNER</b>							
8 X 18 X 9	32	8	4	32	1	115	2848
<b>DIAMOND PRO CAP</b>							
4 X 17¼ / 14 X 10	61.02 LF	10.98 LF	6	54	1.22 LF	53	2858
<b>DIAMOND PRO SMOOTH FACE</b>							
8 X 18 X 12	36	9	4	36	1	79	2844
<b>DIAMOND PRO SMOOTH FACE CORNER</b>							
8 X 17 X 8	22.67	5.64	2	24	.94	82	2640
<b>DIAMOND PRO SMOOTH FACE CAP</b>							
4 X 18 / 12 X 12	67.5 LF	11.25 LF	6	54	1.25 LF	57	3078
<b>UNIVERSAL CAP</b>							
3 X 18 / 12 X 13	90 LF	2.82	8	72	1.25 LF	55	3938
<b>U START BASE BLOCK</b>							
3½ X 18½ X 12	77.84 LF	–	7	56	1.39 LF	51	2839

# DIAMOND PRO STONE CUT®



Scan for additional product information

RESIDENTIAL	COMMERCIAL	STEPS	COLUMNS	FIRE PITS	KITCHEN	FREESTANDING WALL	RETAINING WALL
							
✓	✓	✓	✓				✓

## SHAPES & SIZES

*\*Special Order*

**Diamond Pro Stone Cut Large Unit**

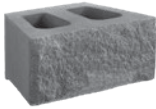

8 x 18 x 12

**Diamond Pro Stone Cut Virtual Joint**



8 x 18 x 12

**Diamond Pro Stone Cut Corner**

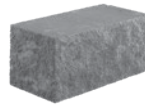

8 x 18 x 9

**Diamond Pro Cap\***

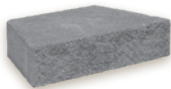

4 x 17¼ / 12 x 10¾

**Universal Cap**



3 x 18 / 12 x 13

**U Start Base Block®**



3½ x 18¾ x 12\*

*Sold separately. Recommended for use with all available wall block units. Visit [Belgard.com](http://Belgard.com) for full product information.*

*\*U Start Base Block actual coverage length is 16¼.*











# DIAMOND PRO STONE CUT®

UNIT	SQFT/ PALLET	SQFT/ LAYER	LAYER/ PALLET	UNITS/ PALLET	SQFT/ UNIT	WEIGHT/ UNIT	WEIGHT/ PALLET
<b>DIAMOND PRO STONE CUT LARGE UNIT</b>							
<b>8 X 18 X 12</b>	32	8	4	32	1	87	2771
<b>DIAMOND PRO STONE CUT VIRTUAL JOINT</b>							
<b>8 X 18 X 12</b>	32	8	4	32	1	79	2515
<b>DIAMOND PRO CORNER</b>							
<b>8 X 18 X 9</b>	32	8	4	32	1	115	2848
<b>DIAMOND PRO CAP</b>							
<b>4 X 17¼ / 12 X 10¾</b>	61.02 LF	10.17 LF	6	54	1.22 LF	53	2862
<b>UNIVERSAL CAP</b>							
<b>3 X 18 / 12 X 13</b>	90 LF	11.25 LF	8	72	1.25 LF	55	3938
<b>U START BASE BLOCK</b>							
<b>3½ X 18⅞ X 12</b>	77.84 LF	–	7	56	1.39 LF	51	2839







Scan for additional  
product information

RESIDENTIAL	COMMERCIAL	STEPS	COLUMNS	FIRE PITS	KITCHEN	FREESTANDING WALL	RETAINING WALL
							
✓		✓	✓	✓	✓	✓	✓

## SHAPES & SIZES

<b>Block</b>	<b>U Start Base Block®</b>
	
4 x 12 x 8	3½ x 18 <sup>7</sup> / <sub>16</sub> x 12*

Sold separately. Recommended for use with all available wall block units. Visit [Belgard.com](http://Belgard.com) for full product information.

\*U Start Base Block actual coverage length is 16<sup>11</sup>/<sub>16</sub>.

UNIT	SQFT/ PALLET	SQFT/ LAYER	LAYER/ PALLET	UNITS/ PALLET	SQFT/ UNITS	WEIGHT/ UNIT	WEIGHT/ PALLET
------	-----------------	----------------	------------------	------------------	----------------	-----------------	-------------------

### UNIVERSAL BLOCK - INDIANAPOLIS, IN PLANT

4 X 12 X 8	31.68	7.92	4	96	.33	30.14	2893
------------	-------	------	---	----	-----	-------	------

### UNIVERSAL BLOCK - SHEFFIELD VILLAGE, OH PLANT









4 X 12 X 8	39.6	6.6	6	120	.33	29.39	3527
------------	------	-----	---	-----	-----	-------	------

### U START BASE BLOCK

3½ X 18 <sup>7</sup> / <sub>16</sub> X 12	77.84 LF	–	7	56	1.39 LF	51	2839
---	----------	---	---	----	---------	----	------



Scan for additional product information

RESIDENTIAL	COMMERCIAL	STEPS	COLUMNS	FIRE PITS	KITCHEN	FREESTANDING WALL	RETAINING WALL
							
✓	✓	✓	✓	✓	✓	✓	✓

## SHAPES & SIZES

### Freestanding Wall



6 x 6 / 4 x 9



6 x 12 / 10 x 9



6 x 18 / 16 x 9



6 x 6 x 12



6 x 12 x 12



6 x 18 x 12

### Retaining Wall

### Column/Corner



6 x 18 x 9

### Universal Cap



3 x 18 / 12 x 13

### U Start Base Block®



3½ x 18¾ x 12\*

*Sold separately. Recommended for use with all available wall block units. Visit [Belgard.com](http://Belgard.com) for full product information.*

*\*U Start Base Block actual coverage length is 16 11/16.*



UNIT	SQFT/ PALLET	SQFT/ LAYER	LAYER/ PALLET	UNITS/ PALLET	SQFT/ UNIT	WEIGHT/ UNIT	WEIGHT/ PALLET
------	-----------------	----------------	------------------	------------------	---------------	-----------------	-------------------

### RETAINING WALL

6 X 6 X 12	8	2	4	32	0.25	31	2912
6 X 12 X 12	16	4		32	0.50	60	
6 X 18 X 12	24	6	4	32	0.75	81	2592

### FREESTANDING WALL

6 X 6 / 4 X 9	8.4	2.1	4	40	0.21	26	3280
6 X 12 / 10 X 9	18.4	4.6		40	0.46	56	
6 X 18 / 16 X 9	28.4	7.1	4	40	0.71	87	3480

### UNIVERSAL CAP

3 X 18 / 12 X 13	90 LF	11.25 LF	8	72	1.25 LF	54.69	3938
------------------	-------	----------	---	----	---------	-------	------









### U START BASE BLOCK

3½ X 18⅞ X 12	77.84 LF	–	7	56	1.39 LF	51	2839
---------------	----------	---	---	----	---------	----	------

# MELVILLE™ WALL



Scan for additional  
product information

RESIDENTIAL	COMMERCIAL	STEPS	COLUMNS	FIRE PITS	KITCHEN	FREESTANDING WALL	RETAINING WALL
							
✓	✓	✓	✓	✓	✓	✓	✓

## SHAPES & SIZES

### Wall Block

### Cap



4 x 20 x 10

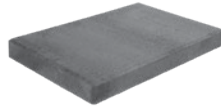

2 x 20 x 13

UNIT	SQFT/ PALLET	SQFT/ LAYER	LAYER/ PALLET	UNITS/ PALLET	SQFT/ UNIT	WEIGHT/ UNIT	WEIGHT/ PALLET
------	-----------------	----------------	------------------	------------------	---------------	-----------------	-------------------

### WALL BLOCK

4 X 20 X 10	26.67	4.44	6	48	.555	524.82	3149
-------------	-------	------	---	----	------	--------	------









### CAP

2 X 20 X 13	100 LF	10 LF	10	60	1.667 LF	245	2450
-------------	--------	-------	----	----	----------	-----	------





Scan for additional product information

RESIDENTIAL	COMMERCIAL	STEPS	COLUMNS	FIRE PITS	KITCHEN	FREESTANDING WALL	RETAINING WALL
							
✓	✓	✓	✓	✓	✓	✓	✓

## SHAPES & SIZES

### FSW/SRW/Column Wall Block



6 x 17¾ x 12

### Anchor™ Fiberglass Pins\*



\*1 box of pins recommended per pallet, pins sold separately.

0.5 x 5

### Universal Cap

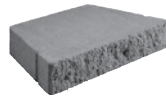

3 x 18 / 12 x 13

### U Start Base Block®



3½ x 18⅞ x 12\*

Sold separately. Recommended for use with all available wall block units. Visit [Belgard.com](http://Belgard.com) for full product information.

\*U Start Base Block actual coverage length is 1611/16.

UNIT	SQFT/PALLET	SQFT/LAYER	LAYER/PALLET	UNITS/PALLET	SQFT/UNIT	WEIGHT/UNIT	WEIGHT/PALLET
<b>WALL BLOCK</b>							
6 X 17¾ X 12	33.3	6.66	5	45	.74	796.5	3983
<b>UNIVERSAL CAP</b>							
3 X 18/12 X 13	22.54	2.82	8	72	.313	492.21	3938
<b>U START BASE BLOCK</b>							
3½ X 18⅞ X 12	77.84 LF	–	7	56	1.39 LF	50.69	2839

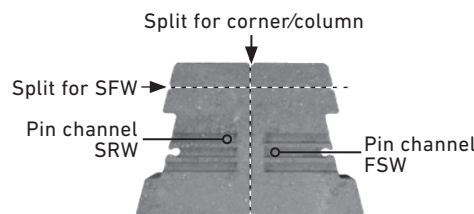









# TANDEM® WALL

## FREESTANDING / RETAINING WALLS

NATURAL COLLECTION   
 METROPOLITAN COLLECTION 



Scan for additional product information

RESIDENTIAL	COMMERCIAL	STEPS	COLUMNS	FIRE PITS	KITCHEN	FREESTANDING WALL	RETAINING WALL
							
✓	✓	✓	✓	✓	✓	✓	✓

### SHAPES & SIZES

#### Ashlar Tandem™



#### Lamina Tandem™

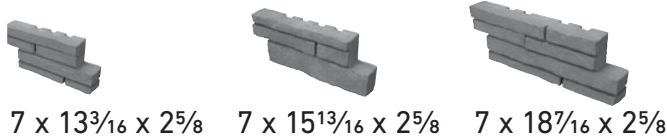

#### Melville Tandem™

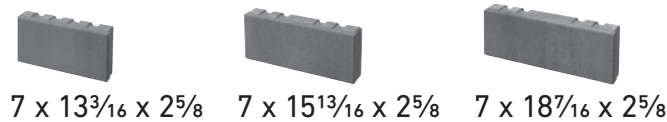

#### Tandem Column



Tandem Unit  
7 x 18 7/16 x 2 5/8

Column Grid  
Height 42

Connector

Items are sold separately. Veneers (1 pallet of Veneers = 2 Columns); Column Grid & Connectors (1 bag of connectors per column grid)

#### Modular Grid Kit



Modular Grid 42 x 28 3/8  
 Connector Panel Connectors & Screws  
 Kit includes: 25 Connectors, 15 Stainless Panel Connectors & 15 Stainless Steel Screws.

#### Tandem Cap Unit



15 x 24 x 3 1/4

#### 8" Connecting Member



3 x 12/8 x 12  
 8" connectors are sold separately

#### Tandem Modular Block® with Universal Connector

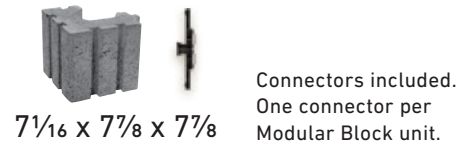

7 1/16 x 7 7/8 x 7 7/8

Connectors included. One connector per Modular Block unit.

#### U Start Base Block®



3 1/2 x 18 1/2 x 12\*

\*Recommended for use with all available wall block units. (Sold Separately)  
 NOTE: U Start Base Block actual coverage length is 16 1/16.

# TANDEM® WALL

FREESTANDING / RETAINING WALLS

NATURAL  
COLLECTION 

METROPOLITAN  
COLLECTION 

UNIT	SQFT/ PALLET	SQFT/ LAYER	LAYER/ PALLET	UNITS/ PALLET	SQFT/ UNIT	WEIGHT/ UNIT	WEIGHT/ PALLET
------	-----------------	----------------	------------------	------------------	---------------	-----------------	-------------------

## ASHLAR TANDEM WALL UNITS

7 X 13 <sup>3</sup> / <sub>16</sub> X 2 <sup>5</sup> / <sub>8</sub>	19.2	3.2	–	30	.64	–	570
7 X 15 <sup>13</sup> / <sub>16</sub> X 2 <sup>5</sup> / <sub>8</sub>	23.1	3.85	–	30	.77	–	696
7 X 18 <sup>7</sup> / <sub>16</sub> X 2 <sup>5</sup> / <sub>8</sub>	27	4.5	–	30	.9	–	816
<b>TOTAL</b>	<b>70.1</b>	<b>11.69</b>	<b>6</b>	<b>90</b>	<b>2.31</b>	<b>175</b>	<b>2082</b>

## MELVILLE TANDEM WALL UNITS

7 X 13 <sup>3</sup> / <sub>16</sub> X 2 <sup>5</sup> / <sub>8</sub>	19.2	3.2	–	30	.64	19	570
7 X 15 <sup>13</sup> / <sub>16</sub> X 2 <sup>5</sup> / <sub>8</sub>	23.1	3.85	–	30	.77	23.2	696
7 X 18 <sup>7</sup> / <sub>16</sub> X 2 <sup>5</sup> / <sub>8</sub>	27	4.5	–	30	.90	27.2	816
<b>TOTAL</b>	<b>70.1</b>	<b>11.69</b>	<b>6</b>	<b>90</b>	<b>2.31</b>	<b>–</b>	<b>2082</b>

## LAMINA TANDEM WALL UNITS

7 X 13 <sup>13</sup> / <sub>16</sub> X 2 <sup>5</sup> / <sub>8</sub>	15.576	2.596	–	24	.649	77.08	462.48
7 X 15 <sup>7</sup> / <sub>16</sub> X 2 <sup>5</sup> / <sub>8</sub>	18.696	3.116	–	24	.779	92.52	555.12
7 X 18 <sup>1</sup> / <sub>16</sub> X 2 <sup>5</sup> / <sub>8</sub>	21.816	3.636	–	24	.909	108	648
<b>TOTAL</b>	<b>56.08</b>	<b>9.346</b>	<b>6</b>	<b>72</b>	<b>–</b>	<b>277.6</b>	<b>1666</b>

## TANDEM CAP UNIT

15 X 24 X 3 <sup>1</sup> / <sub>4</sub>	20 SF 64 LF	2.5	8	32	.625 SF 2 LF	373.75	2990
---	----------------	-----	---	----	-----------------	--------	------

## COLUMN UNIT

7 X 18 <sup>1</sup> / <sub>2</sub> X 2 <sup>5</sup> / <sub>8</sub>	45.43	9	5	50	2 COLUMNS/ PALLETS	27	1350
--	-------	---	---	----	-----------------------	----	------

## TANDEM MODULAR BLOCK

7 <sup>7</sup> / <sub>16</sub> X 7 <sup>7</sup> / <sub>8</sub> X 7 <sup>7</sup> / <sub>8</sub>	49.29	12.32	4	128	0.389	22	2816
--	-------	-------	---	-----	-------	----	------

## U START BASE BLOCK









3 <sup>1</sup> / <sub>2</sub> X 18 <sup>1</sup> / <sub>2</sub> X 12	77.84 LF	–	7	56	1.39 LF	51	2839
---	----------	---	---	----	---------	----	------







# VERSA-LOK® STANDARD



Scan for additional product information

RESIDENTIAL	COMMERCIAL	STEPS	COLUMNS	FIRE PITS	KITCHEN	FREESTANDING WALL	RETAINING WALL
							
✓	✓	✓	✓	✓		✓	✓

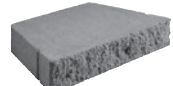
## SHAPES & SIZES









Standard	Versa-lok C Cap*	Universal Cap	Versa-Pin**
			
6 x 16 / 14 x 12	3 <sup>5</sup> / <sub>8</sub> x 15 <sup>5</sup> / <sub>8</sub> x 11 <sup>5</sup> / <sub>8</sub>	3 x 18 / 12 x 13	2 Versa-Pins Per Block

\*C Cap is only manufactured in Sheffield Village, Ohio. \*\*Sold separately

UNIT	SQFT/PALLET	SQFT/LAYER	LAYER/PALLET	UNITS/PALLET	SQFT/UNITS	WEIGHT/UNIT	WEIGHT/PALLET
<b>VERSA-LOK</b>							
6 X 16 / 14 X 12	24	6	4	36	.667	764.91	3060
<b>VERSA-LOK C CAP</b>							
3 <sup>5</sup> / <sub>8</sub> X 15 <sup>5</sup> / <sub>8</sub> X 11 <sup>5</sup> / <sub>8</sub>	83.79 LF	11.97 LF	7	63	1.33 LF	47.93	3020
<b>UNIVERSAL CAP</b>							
3 X 18 / 12 X 13	22.54	2.82	8	72	.313	492.21	3938



Scan for additional  
product information

RESIDENTIAL	COMMERCIAL	STEPS	COLUMNS	FIRE PITS	KITCHEN	FREESTANDING WALL	RETAINING WALL
							
✓		✓	✓	✓	✓	✓	✓

## SHAPES & SIZES

### Small



6 x 9 / 6 x 10

### Medium



6 x 12 / 6 x 10

### Large



6 x 18 / 15 x 10

### Universal Cap



3 x 18 / 12 x 13

### Corner Unit



6 x 12 x 10

UNIT	SQFT/ PALLET	SQFT/ LAYER	LAYER/ PALLET	UNITS/ PALLET	SQFT/ UNITS	WEIGHT/ UNIT	WEIGHT/ PALLET
------	-----------------	----------------	------------------	------------------	----------------	-----------------	-------------------

## WELLINGTON WALL

6 X 9/6 X 10	6	1.5	–	16	.375	37.88	606
6 X 12/6 X 10	8	2	–	16	.50	50.5	808
6 X 18/15 X 10	12	3	–	16	.75	75.75	1212
TOTAL	26 SRW 23 FSW	6.5	4	48	1.625	–	2626

## UNIVERSAL CAP









3 X 18/12 X 13	90 LF	11.25 LF	8	72	1.25 LF	54.69	3938
----------------	-------	----------	---	----	---------	-------	------

## CORNER UNIT

6 X 12 X 10	16	8	2	32	.5	59	1888
-------------	----	---	---	----	----	----	------



Scan for additional product information

RESIDENTIAL	COMMERCIAL	STEPS	COLUMNS	FIRE PITS	KITCHEN	FREESTANDING WALL	RETAINING WALL
							
✓		✓	✓	✓	✓	✓	✓

## SHAPES & SIZES

### 3-Piece



4 x 8 / 5 x 8



4 x 12 / 9 x 8



4 x 16 / 13 x 8

### Universal



4 x 12 x 8

UNIT	SQFT/PALLET	SQFT/LAYER	LAYER/PALLET	UNITS/PALLET	SQFT/UNITS	WEIGHT/UNIT	WEIGHT/PALLET
------	-------------	------------	--------------	--------------	------------	-------------	---------------

### 3-PIECE MODULAR

4 X 8/5 X 8	9.24	1.32	–	42	.22	101.46	710.22
4 X 12/9 X 8	13.86	1.98	–	42	.33	157.38	1101.66
4 X 16/13 X 8	18.48	2.64	–	42	.44	218.46	1529.22
TOTAL	42	–	7	126	.99	477.3	3341

### UNIVERSAL

4 X 12 X 8	40	6.67	6	120	.333	30.14	3617
------------	----	------	---	-----	------	-------	------

# WESTON STONE™ INSTALLATION INSTRUCTIONS

This is a pinless system. Maximum wall height is 2½ feet. Walls exceeding 2½ feet in height may require geogrid reinforcing and the consultation of a qualified engineer. Contact your Belgard sales representative or dealer for assistance.

Weston Stone wall units must be glued with a quality construction adhesive to develop the necessary mechanical bond. All measurements herein are approximate. Natural materials are used in the manufacturing of this product.

## WESTON STONE™ WALL PATTERNS

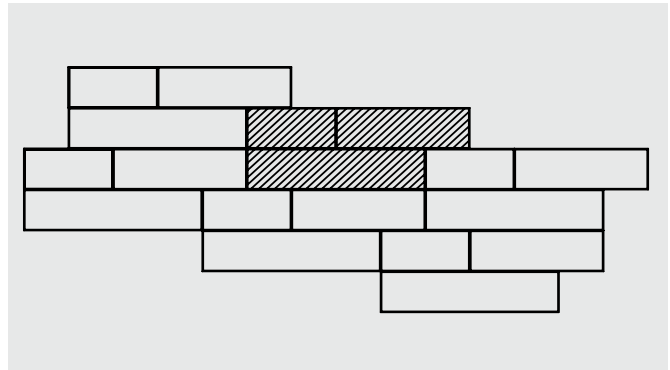
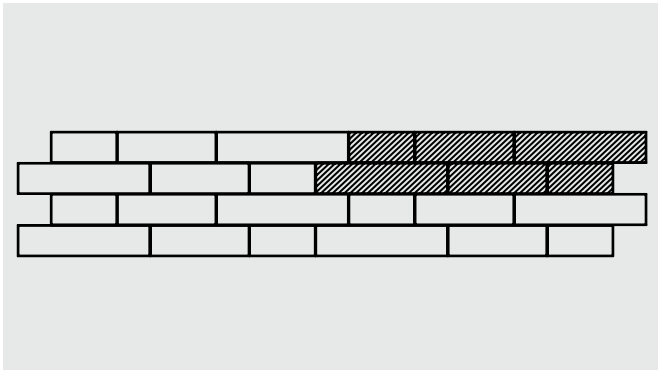

## TYPICAL CROSS SECTION WITH WESTON STONE SEAT WALL

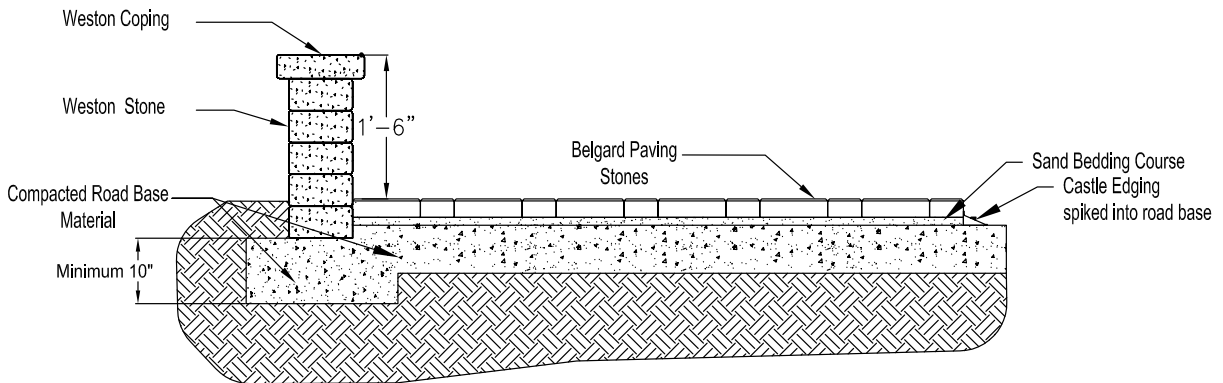

## TREE RINGS WITH WESTON STONE

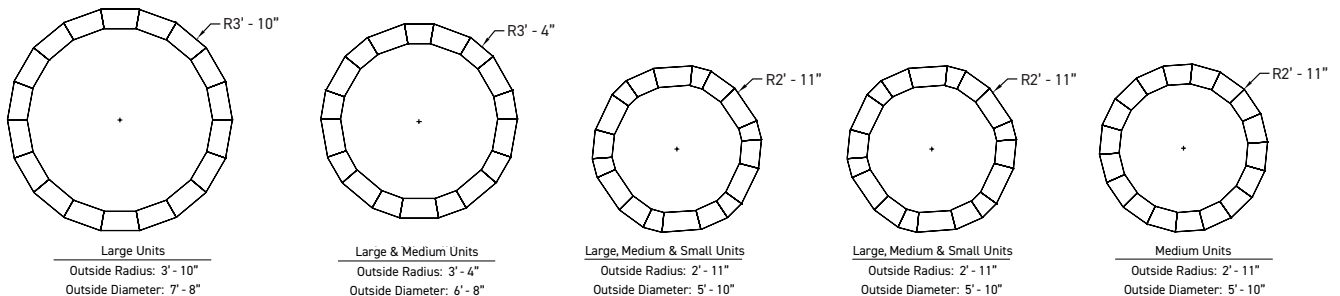



# FIRE FEATURES

## FIRE FEATURES INSTALLATION GUIDE

83 Installation Instructions

## FIRE FEATURES

84 Melville™ Series

87 Beaufort™ Series

90 Bordeaux™ Series

93 Weston Stone Fire Pit Kit

# STANDARD INSTALLATION INSTRUCTIONS

## GRAVEL BASE

Gravel Fill shall be a clean angular stone or angular granular fill meeting the following gradation as determined in accordance with ASTM D 422.

Sieve Size	Percent Passing
1-in	100
3/4-in	75-100
No. 4	0-60
No. 40	0-50
No. 200	0-12

## FOUNDATION PREPARATION

Following excavation of the leveling pad, foundation soil shall be examined to assure the actual foundation soil strength meets or exceeds the assumed design bearing strength. Soils not meeting the required strength shall be removed and replaced with soil meeting the design criteria.



*Scan for Fortified Installation Method  
to be used with soft soils or expanding clays*

## LEVELING PAD PREPARATION

A minimum 18-in thick layer or compacted granular material shall be placed for use as a leveling pad up to the grades and locations as shown on the construction drawings. The granular base shall be compacted to a firm, level bearing pad on which to place the bottom level of the unit. A leveling pad consisting of 6-in (minimum) thick lean, unreinforced concrete may be used at the contractor's option, or if so detailed on the plans. The leveling pad should extend a minimum of 6-in from the toe and from the heel of the unit base.

## GRAVEL FILL

Gravel fill shall be placed to the minimum finished thickness and width shown on the construction plans.

Gravel lifts shall be a maximum thickness of 6-in.

Lifts shall be compacted by three passes of a light weight vibratory plate compactor.

For areas not affected by freeze-thaw conditions please contact your local Belgard sales representative for further installation information.

# MELVILLE™ SERIES

METROPOLITAN  
COLLECTION 



*Scan for additional  
product information*





# MELVILLE™ SERIES

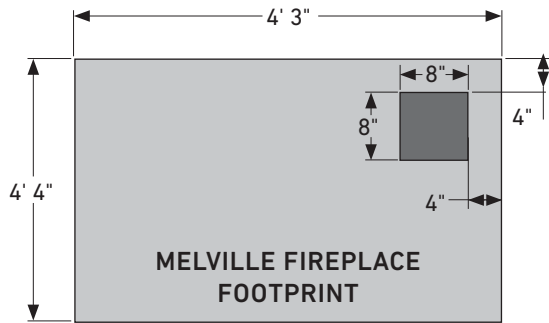

## FIREPLACE

Rough Dimensions:  
2' 7" D x 4' 3" W x 7' 8" H

Approximate Weight:  
4205 lbs.

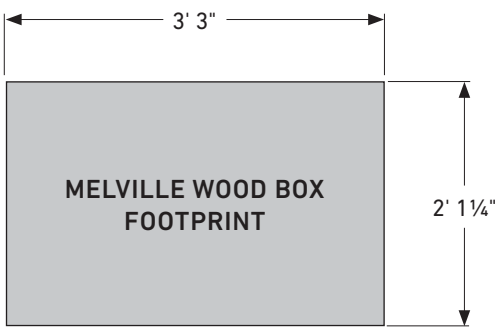
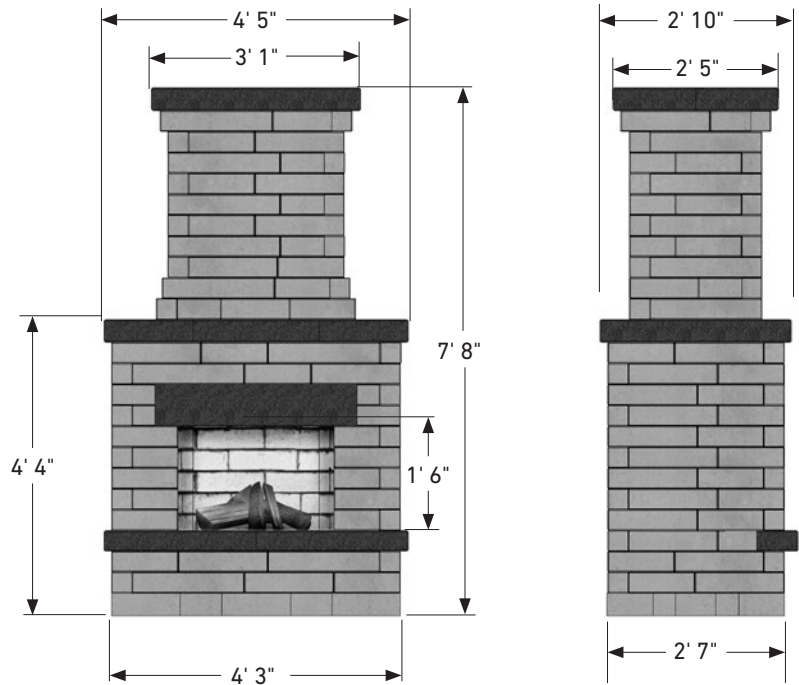

## WOOD BOXES

Rough Dimensions:  
2' 1" D x 3' 3" W x 3' 1" H

Approximate Weight:  
3070 lbs. or 1535 lbs. each

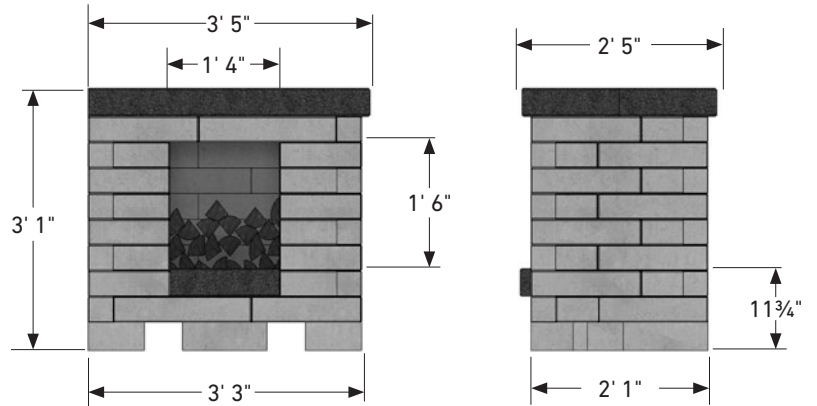

## GRILL ISLAND

Rough Dimensions:  
2' 8" D x 5' 11" W x 3' 5" H

Approximate Weight:  
3500 lbs.

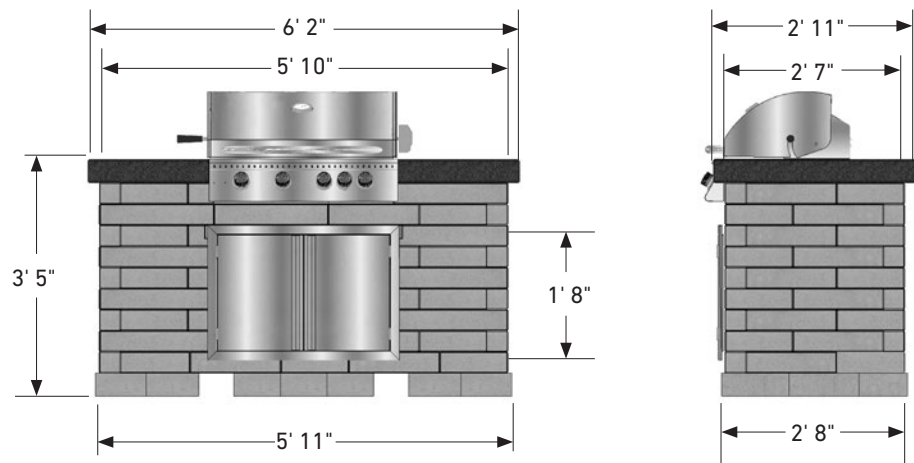

# MELVILLE™ SERIES

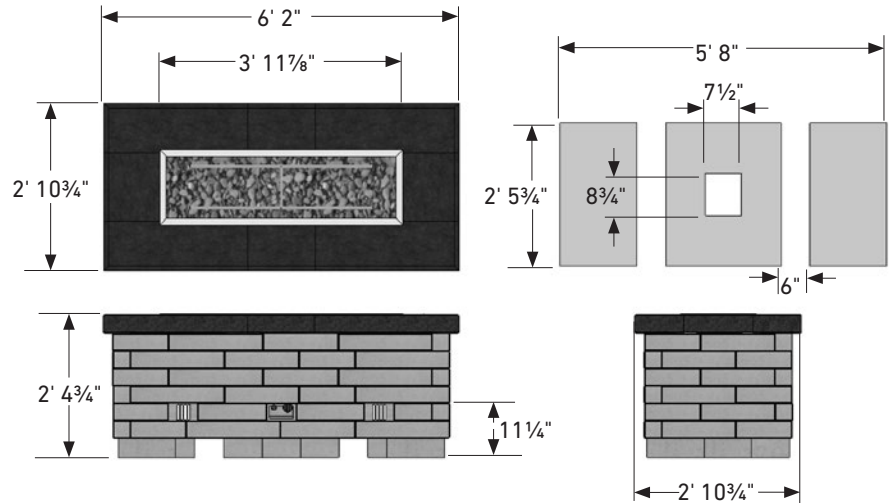

## LINEAR FIRE TABLE

Rough Dimensions:  
2' 6" D x 5' 8" W x 2' 5" H

Approximate Weight:  
2500 lbs.

## LINEAR FIREPLACE

Rough Dimensions:  
2' 6" D x 7' 1" W x 5' 4" H

Approximate Weight:  
4000 lbs.

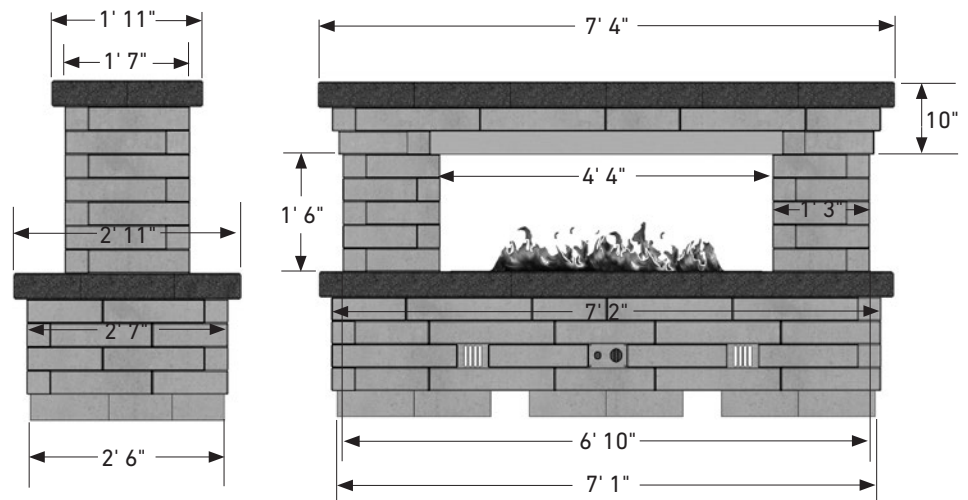

### FIREPLACE

13070020  
Melville Wood Fireplace  
Colors: Scandina Gray/Midnight

### WOOD BOXES

13140010  
Melville Wood Boxes (Pair)  
Colors: Scandina Gray/Midnight

*36" wood burning fireplace can be converted to a vented gas unit on-site.*

### GRILL ISLAND

Melville Grill Island (NG)  
Colors: Scandina Gray/Midnight

Melville Grill Island (LP)  
Colors: Scandina Gray/Midnight

### LINEAR FIREPLACE

13000026  
Melville Linear Fireplace  
Colors: Scandina Gray/Midnight

### LINEAR FIRE TABLE

13000027  
Melville Linear Fire Table  
Colors: Scandina Gray/Midnight

# BEAUFORT™ SERIES

NATURAL  
COLLECTION 



Scan for additional  
product information

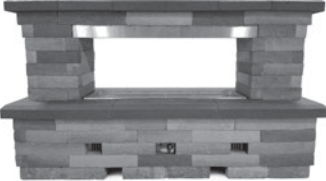

# BEAUFORT™ SERIES

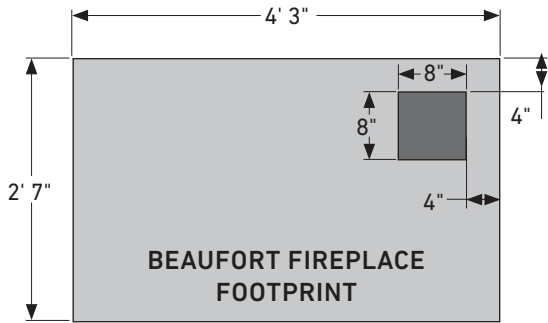

## FIREPLACE

Rough Dimensions:  
2' 7" D x 4' 3" W x 7' 8" H

Approximate Weight:  
4170 lbs.

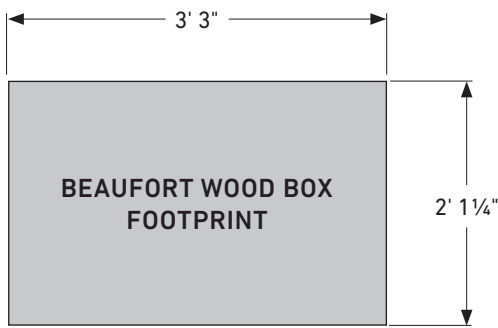
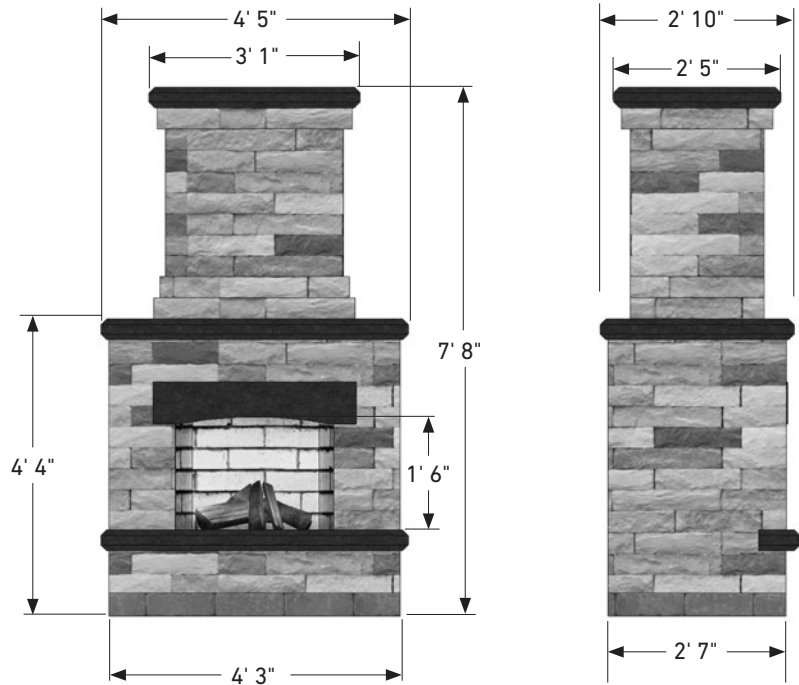

## WOOD BOXES

Rough Dimensions:  
2' 1" D x 3' 3" W x 3' 1" H

Approximate Weight:  
3070 lbs.

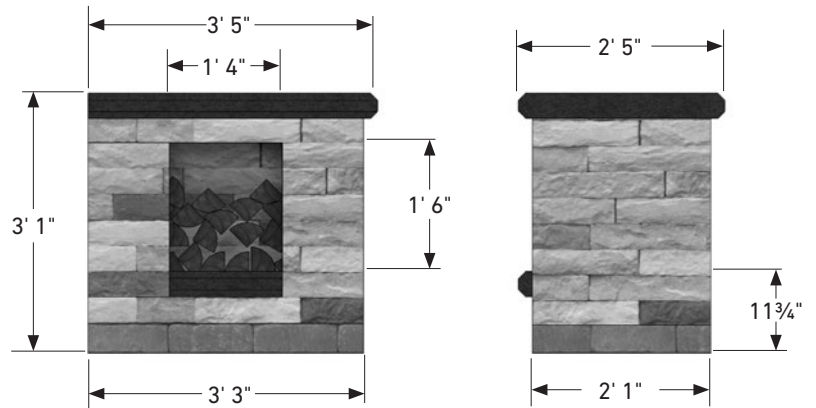

## GRILL ISLAND

Rough Dimensions:  
2' 8" D x 6' W x 3' 5" H

Approximate Weight:  
3140 lbs.

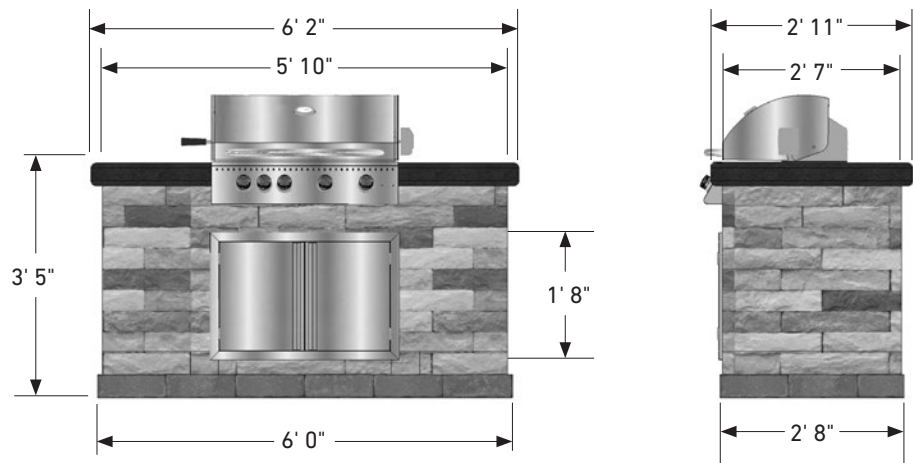

# BEAUFORT™ SERIES

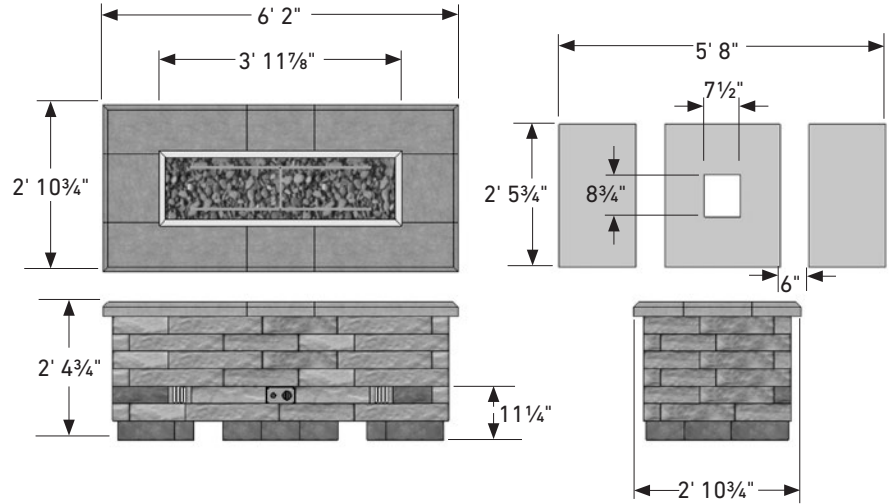

## LINEAR FIRE TABLE

Rough Dimensions:  
2' 6" D x 5' 8" W x 2' 5" H

Approximate Weight:  
2500 lbs.

## LINEAR FIREPLACE

Rough Dimensions:  
2' 6" D x 7' 1" W x 5' 4" H

Approximate Weight:  
3700 lbs.

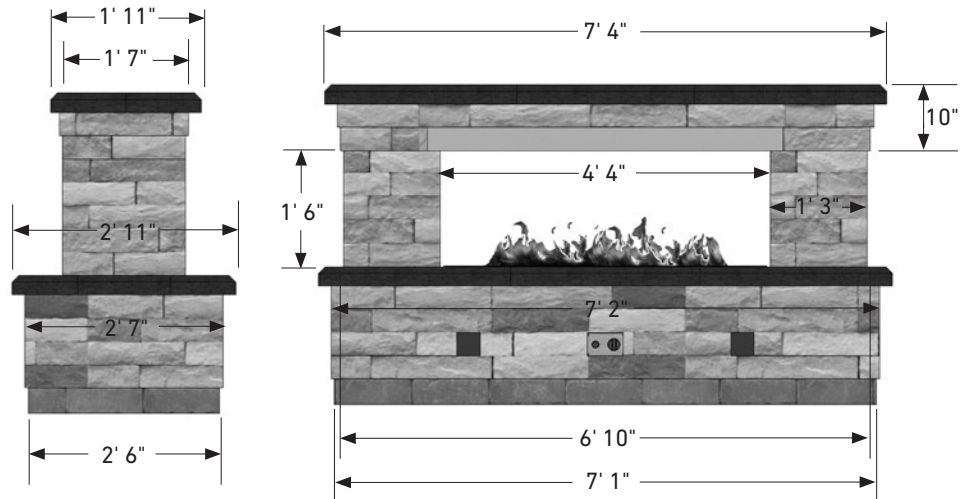

### FIREPLACE

13070010  
Beaufort Wood Fireplace  
Colors: Shelby/Midnight

### WOOD BOXES

13140505  
Beaufort Wood Boxes (Pair)  
Colors: Shelby/Midnight

*36" wood burning fireplace can be converted to a vented gas unit on-site.*

### GRILL ISLAND

13110518  
Beaufort Grill Island (NG)  
Colors: Shelby/Midnight

13110818  
Beaufort Grill Island (LP)  
Colors: Shelby/Midnight

### LINEAR FIREPLACE

13000018  
Beaufort Linear Fireplace  
Colors: Shelby/Midnight

### LINEAR FIRE TABLE

13000205  
Beaufort Linear Fireplace  
Colors: Shelby/Midnight



# BORDEAUX™ SERIES

NATURAL  
COLLECTION 



Scan for additional  
product information



# BORDEAUX™ SERIES

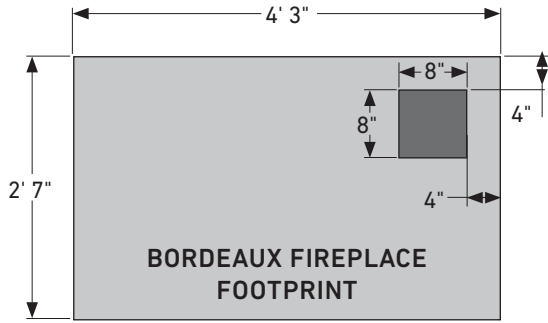

## FIREPLACE

Rough Dimensions:  
2' 7" D x 4' 3" W x 7' 8" H

Approximate Weight:  
4200 lbs.

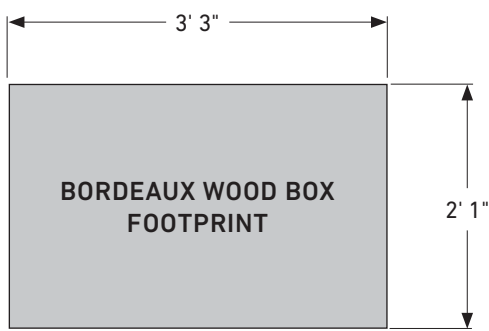
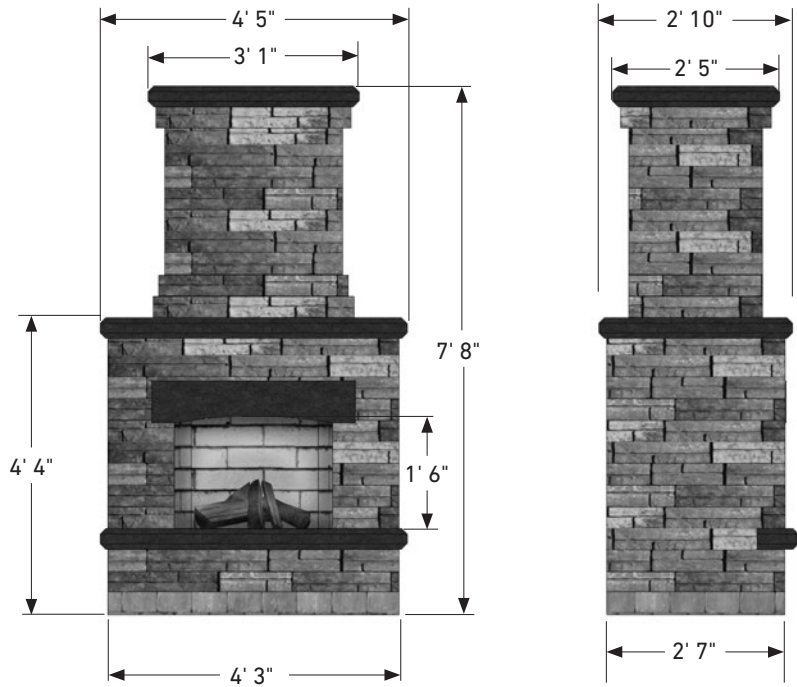

## WOOD BOXES

Rough Dimensions:  
2' 1" D x 3' 5" W x 3' 1" H

Approximate Weight:  
3070 lbs.

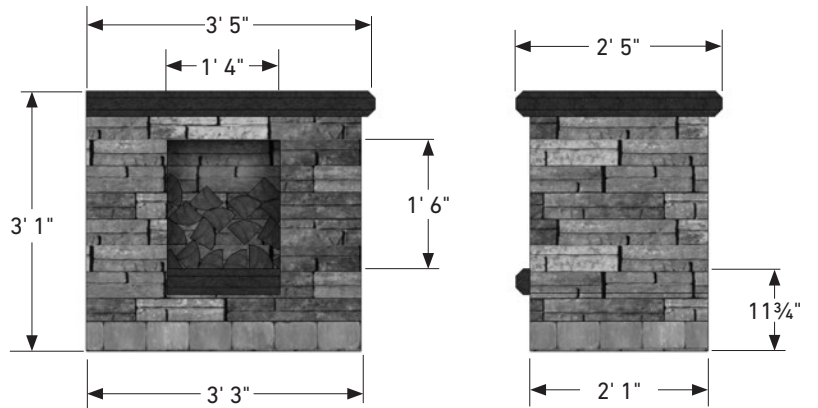

## GRILL ISLAND

Rough Dimensions:  
2' 8" D x 6' W x 3' 5" H

Approximate Weight:  
2500 lbs.

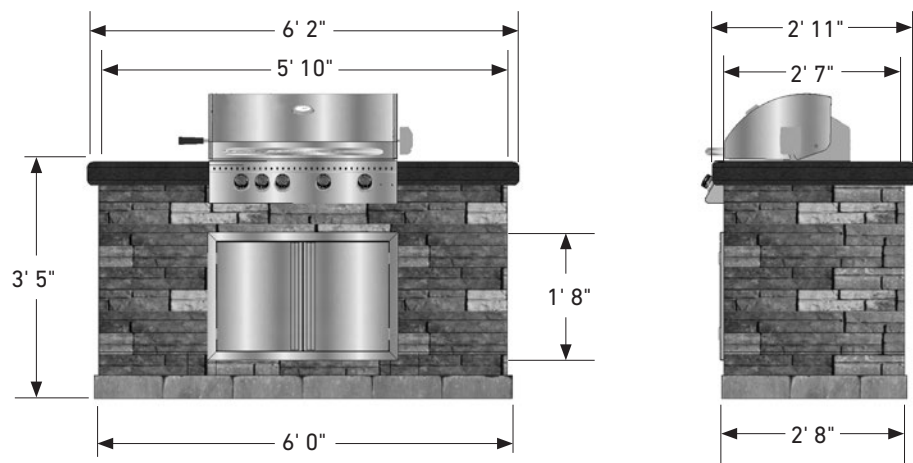



# BORDEAUX™ SERIES

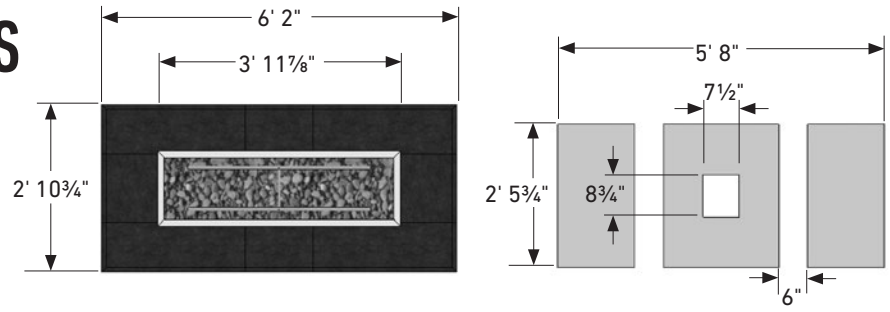

## LINEAR FIRE TABLE

Rough Dimensions:  
2' 10<sup>3</sup>/<sub>4</sub>" D x 6' 2" W x 2' 4<sup>3</sup>/<sub>4</sub>" H  
Approximate Weight:  
2500 lbs.



## LINEAR FIREPLACE

Rough Dimensions:  
2' 6" D x 7' 1" W x 5' 4" H  
Approximate Weight:  
3700 lbs.

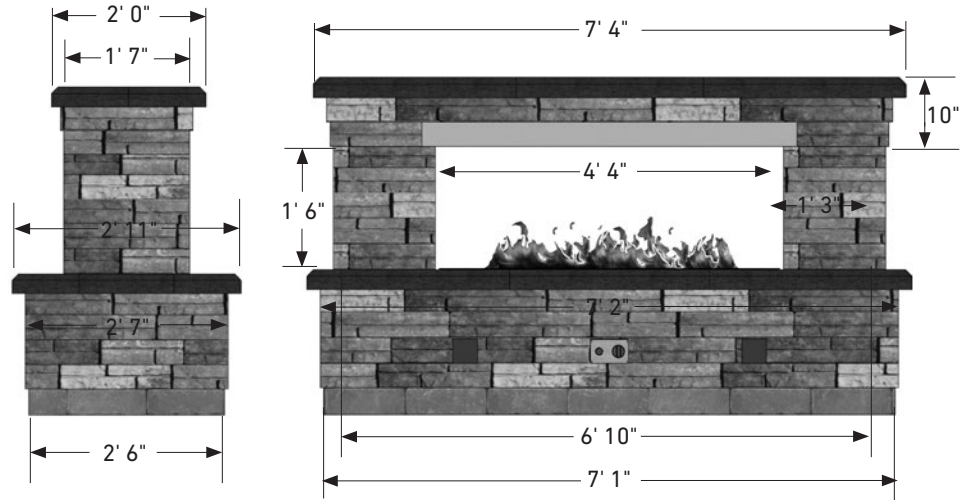

### FIREPLACE

70300791  
Bordeaux Wood Fireplace  
Colors: Lamina Sienna/Cordova  
Stone Buff Base + Top

13070014  
Bordeaux Wood Fireplace  
Colors: Lamina Sienna/Cordova  
Midnight Base + Top

13070012  
Bordeaux Wood Fireplace  
Colors: Lamina Pewter  
Midnight Base + Top

### WOOD BOXES

13140001  
Bordeaux Wood Boxes (Pair)  
Colors: Lamina Sienna/  
Cordova Stone Buff

13140020  
Bordeaux Wood Boxes (Pair)  
Colors: Lamina Sienna/  
Cordova Stone Midnight

13140021  
Bordeaux Wood Boxes (Pair)  
Colors: Lamina Pewter  
Midnight Base + Top

### GRILL ISLAND

13110010  
Bordeaux Grill Island (NG)  
Colors: Lamina Sienna/  
Cordova Stone Buff  
+ Stainless

13110011  
Bordeaux Grill Island (LP)  
Colors: Lamina Sienna/  
Cordova Stone Buff  
+ Stainless

13110014  
Bordeaux Grill Island (NG)  
Colors: Lamina Sienna/  
Cordova Stone Midnight  
+ Stainless

13110015  
Bordeaux Grill Island (LP)  
Colors: Lamina Sienna/  
Cordova Stone Midnight  
+ Stainless

Bordeaux Grill Island (NG)  
Colors: Pewter/Midnight  
+ Stainless

Bordeaux Grill Island (LP)  
Colors: Pewter/Midnight  
+ Stainless

### LINEAR FIREPLACE

13000021  
Bordeaux Linear Fireplace  
Colors: Sienna/Buf

13000019  
Bordeaux Linear Fireplace  
Colors: Sienna/Midnight

13000020  
Bordeaux Linear Fireplace  
Colors: Pewter/Midnight

### LINEAR FIRE TABLE









13000023  
Bordeaux Linear Fire Table  
Colors: Sienna/Buf

13000204  
Bordeaux Linear Fire Table  
Colors: Sienna/Midnight

13000203  
Bordeaux Linear Fire Table  
Colors: Pewter/Midnight

36" wood burning fireplace can be converted to a vented gas unit on-site.

# WESTON STONE™ FIRE PIT KIT

RESIDENTIAL	COMMERCIAL	STEPS	COLUMNS	FIRE PITS	KITCHEN	FREESTANDING WALL	RETAINING WALL
							
✓				✓			

## SHAPES & SIZES

### Fire Pit Kit



4 x 8 x 8



4 x 12 x 8

### Fire Ring



Outside is 55" in diameter  
 Inside is 39.5" in diameter  
 Stacks up to 4 rows high  
 Metal ring insert included in kit

UNIT	SQFT/ PALLET	SQFT/ LAYER	LAYER/ PALLET	UNITS/ PALLET	UNITS/ SQFT	WEIGHT/ UNIT	WEIGHT/ PALLET
------	-----------------	----------------	------------------	------------------	----------------	-----------------	-------------------

### FIRE PIT KIT

4 X 8 X 8	-	-	-	36	-	-	-
4 X 12 X 8	-	-	-	36	-	-	-
TOTAL	-	-	4	-	-	-	1632

## FIRE PIT KITS INSTALLATION INSTRUCTIONS

- Always use in accordance with all applicable local and state fire codes
- Failure to follow these instructions could result in a hazardous fire causing property damage or physical injury
- Caution: For outdoor use only
- Use the fire ring on stone, dirt or sand surfaces
- For adult use only — do not allow children to use the fire ring
- Do not use on lawns, wooden decks, concrete or asphalt
- Do not use fire ring indoors or under a patio roof
- Do not use in windy conditions
- Do not leave fire unattended at any time
- Do not use under tree branches, trellis, or overhangs of any kind, including covered porches
- Do not use flammable liquids such as gasoline, alcohol, diesel fuel, kerosene, or charcoal lighter fluid to light or relight fires as this may also cause paint to flake off fire ring
- Care should be taken to make sure all combustible material is far enough away from the fire ring not to ignite it
- Avoid using softwoods such as pine or cedar because they are likely to throw sparks — hardwoods are recommended
- Keep children and pets away from the fire ring while it is in use
- Exercise the same precautions you would with any open fire
- Do not wear flammable or loose clothing when tending an open fire
- Avoid touching surfaces as they will be extremely hot
- Assure the fire is completely extinguished before leaving fire ring
- Any modifications to this appliance may be dangerous and are not permitted

### ADDITIONAL MATERIALS NEEDED

- Tamper
- Level
- 2 Bags of Leveling Sand
- 2 Tubes of Concrete Adhesive
- Caulk Gun
- 3 Bags of Gravel or Lava Rock
- Shovel
- Optional Marking Paint or Chalk





# ACCESSORIES

## ACCESSORIES

- 96 Anglia Edger®
- 97 Artforms™
- 99 Granika Step®
- 100 Landings™ Step Unit
- 103 Marina™ Coping



Scan for additional  
product information

RESIDENTIAL	COMMERCIAL	STEPS	CAPS	COPING
				
✓	✓			

## SHAPES & SIZES

### Multi-Piece



5 1/4 x 7 5/8 x 8



5 1/4 x 10 x 8



5 1/4 x 15 5/8 x 8



5 1/4 x 17 5/8 x 8









UNIT	SQFT/ PALLET	SQFT/ LAYER	LAYER/ PALLET	UNITS/ PALLET	UNITS/ LAYER	WEIGHT/ UNIT	WEIGHT/ PALLET
------	-----------------	----------------	------------------	------------------	-----------------	-----------------	-------------------

### MULTI-PIECE

5 1/4 X 7 5/8 X 8	8 LF	2.67 LF	–	12	4	25.7	308
5 1/4 X 10 X 8	10 LF	3.33 LF	–	12	4	31	372
5 1/4 X 15 5/8 X 8	15.75 LF	5.25 LF	–	12	4	48	576
5 1/4 X 17 5/8 X 8	36 LF	12 LF	–	24	8	56	1344
TOTAL	69.75 LF	–	3	60	20	–	2600



Scan for additional product information

RESIDENTIAL	COMMERCIAL	STEPS	CAPS	FIRE PITS	KITCHEN	FREESTANDING WALL	RETAINING WALL
							
✓	✓	✓	✓	✓	✓	✓	

## SHAPES & SIZES

18 x 36

6 x 36

Installation Hardware



18 x 36 x 3



6 x 36 x 3

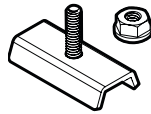

Anchor Slide & Nut

50 per box

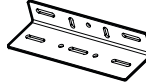

Joining Plate

10 per box

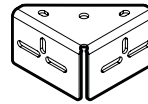

Outer Corner

10 per box

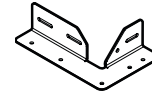

Inner Corner

10 per box

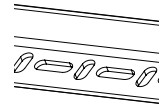

Stretcher

10 in a bundle

UNIT	SQFT/PALLET	SQFT/LAYER	LAYER/PALLET	UNITS/PALLET	UNITS/LAYER	SQFT/UNIT	WEIGHT/PALLET
------	-------------	------------	--------------	--------------	-------------	-----------	---------------

18 x 36	81	9	9	18*	2	4.5	2676
6 x 36	31.5	10.5	3	21*	7	1.5	1049

\*Total number of both open and closed end panels. 18 x 36 pallets contain 9 of each. 6 x 36 pallets contain 3 open end panels and 18 closed end panels

18 X 36 X 3

6 X 36 X 3

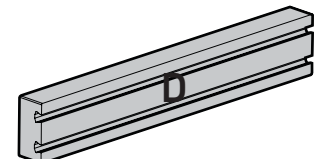
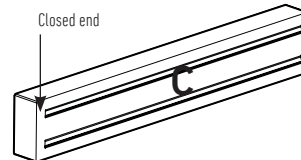
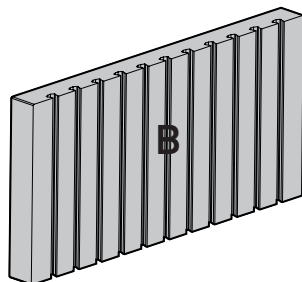
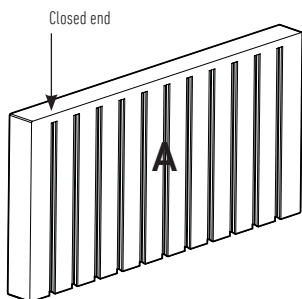

# PANEL CONFIGURATIONS

## IDEAL:

This configuration uses equal number of panel A and panel B.

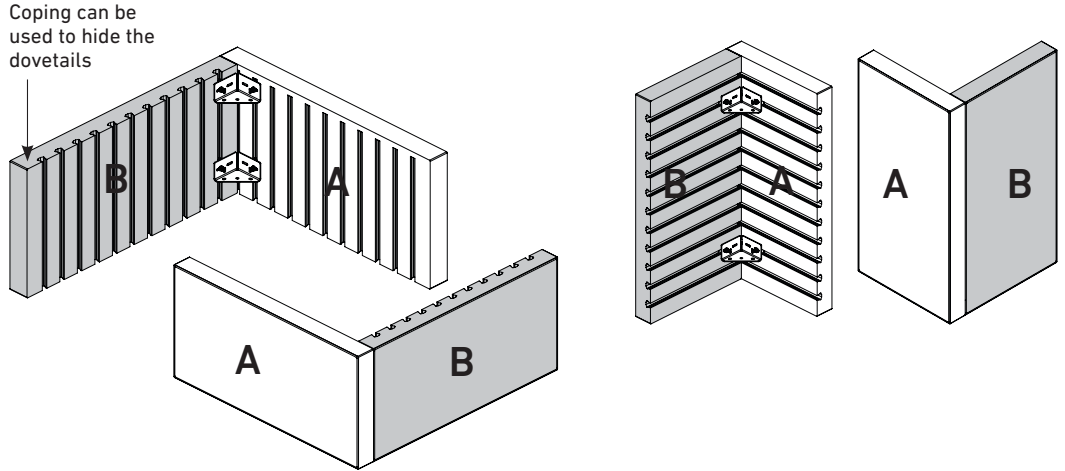

## NOT OPTIMAL:

This configuration uses panel A only.

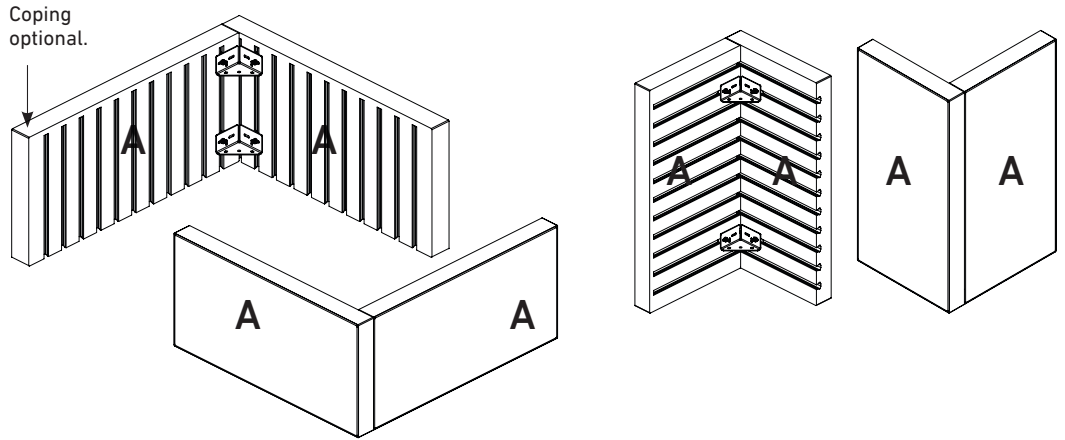

## NOT RECOMMENDED:

This configuration uses panel B only and the dovetails are exposed. Use ideal configuration as shown above.

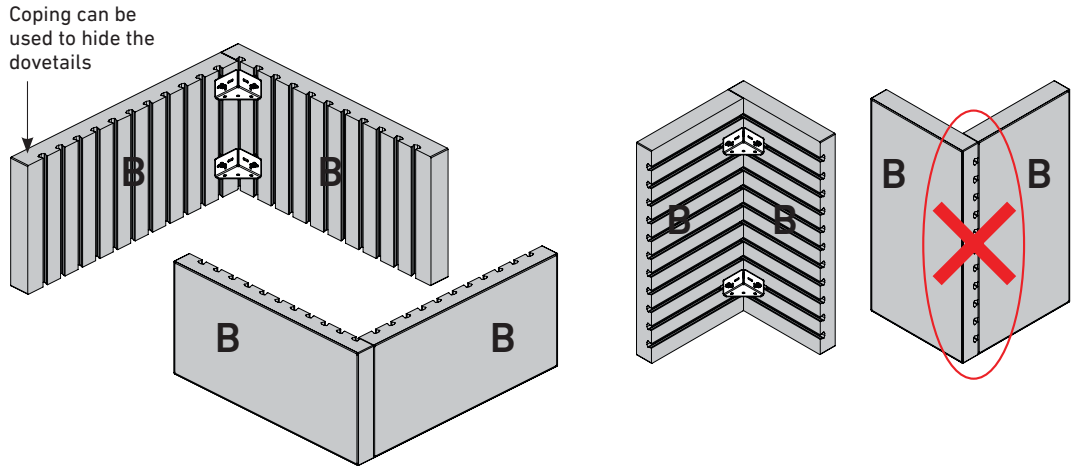





\*IMPORTANT: When planning configurations, consider the amount of panel A and panel B on a pallet. 18 x 36" panels are sold in pair/layer or in full pallet only. 6 x 36" panels are sold in layer or in full pallet only.





Scan for additional  
product information

RESIDENTIAL	COMMERCIAL	STEPS	CAPS	COPING
				
✓	✓	✓		

## SHAPES & SIZES

### Step Unit



6 x 38 x 16





UNIT	SQFT/ PALLET	SQFT/ LAYER	LAYER/ PALLET	UNITS/ PALLET	SQFT/ UNIT	WEIGHT/ UNIT	WEIGHT/ PALLET
<b>STEP UNIT</b>							
<b>6 X 38 X 16</b>	25.33 LF	6.33 LF	4	8	3.17 LF	281.25	2250

# LANDINGS™ STEP UNIT

NATURAL  
COLLECTION 



Scan for additional  
product information

RESIDENTIAL	COMMERCIAL	STEPS	CAPS	COPING
				
✓	✓	✓		

## SHAPES & SIZES

### Step Unit



6 x 48 x 18

UNIT	SQFT/ PALLET	SQFT/ LAYER	LAYER/ PALLET	UNITS/ PALLET	SQFT/ UNIT	WEIGHT/ UNIT	WEIGHT/ PALLET
<b>STEP UNIT</b>							
<b>6 X 48 X 18</b>	24 LF	8 LF	3	6	4 LF	460	2760



# LANDINGS™ STEP UNIT INSTALLATION

Each Landings™ Step Unit is manufactured with two unique face patterns. The step units are palletized and packaged for easy skid-steer loader removal. Care needs to be taken in handling these units. If a blemish occurs on one side of unit, rotate 180° before setting unit into place.

## BASE COURSE

Excavate an area 6 inches deep by 1 foot longer by 1 foot wider than the installed step(s) size. Add a minimum of 6 inches of compactable base material, 3/4-inch minus (with fines) aggregate. Compact and level. Set unit and, if desired, add a slight pitch of no more than 1/4 inch toward the front of the step to shed moisture. If installing step units next to a retaining wall, keep units level from front to back.

The Textures on Sides 1 and 2 are Designed to Nest with Minimal Gapping Between the Units.

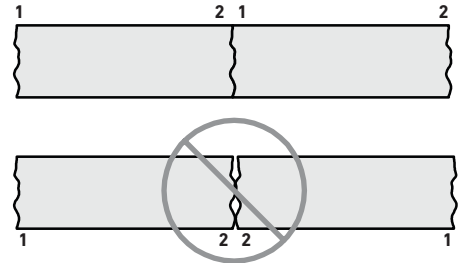

Place Units so They Nest Tightly Together.



Two unique faces on each step

## STAIR TREAD

For each consecutive step, follow base course instructions, making sure the top of the base is even with the top of the previously installed unit. Recommended tread depth is a minimum of 10 inches, but no more than 16 inches. When installing steps adjacent to a finished surface such as pavers, as illustrated, a 6-inch-tall dummy block needs to be installed below the first step.

## LANDING

For landing(s) follow base course instructions. Each step unit is manufactured with two unique face patterns. The face patterns are manufactured to nest together, which will create a narrower joint, providing pleasing aesthetics.

## STEPS IN A 90-DEGREE WALL

When building into a retaining wall, construct the steps first and build the walls adjacent to the steps.

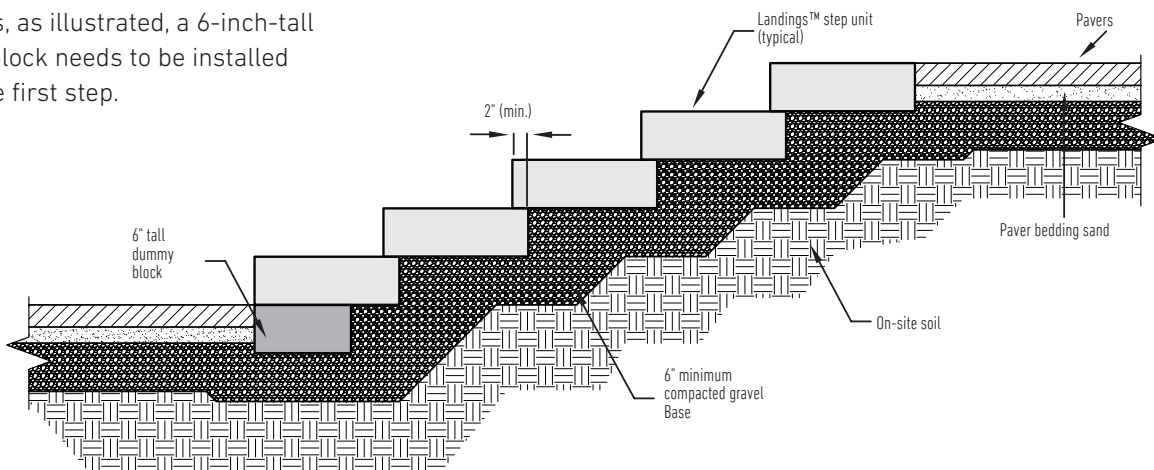

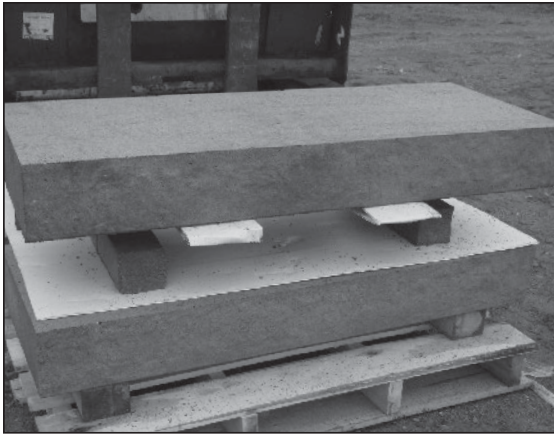

## SKID-STEER LOADER

Slide forks underneath the first step unit and lift off pallet. Set the step unit onto its desired location, using a spacer to ease in fork removal.



A helpful tip to protect the step unit is to wrap the fork of the skid-steer with corrugated plastic packaging from the pallet or other protective materials. Secure to the forks.



## CLAMP

Using a materials clamp, center the clamp on the step unit. Attach clamp to skid-steer or mini-excavator and slowly lift the step unit off of the pallet and move it into place. Be sure to have a second person to help guide the unit into place as the machine sets the step unit down.



## STRAPS

When using a heavy duty strap(s), start by wrapping the strap(s) around the center if using one or close to step unit ends if two straps are being used. Cinch the strap(s) tight and attach the looped ends of the strap(s) to skid-steer or mini-excavator. Slowly lift the step unit from the pallet and move it into place. Be sure to have a second person to help guide the unit into place as the machine sets the step unit down. Using a spacer will help to ease in the strap removal.

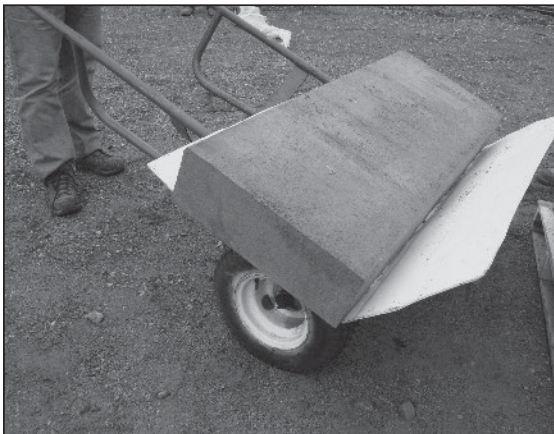

## CART





When using a cart, place provided corrugated plastic from pallet or other protective material onto the cart to help protect the step unit. With help from a second person, slowly slide the step unit from the pallet onto the cart. Maneuver the unit carefully into place.

Videos can be found on our YouTube channel:  
[www.youtube.com/anchorblockmn](http://www.youtube.com/anchorblockmn)

# MARINA™ COPING



Scan for additional product information

RESIDENTIAL	COMMERCIAL	STEPS	CAPS	COPING
				
✓	✓	✓	✓	✓

## SHAPES & SIZES

### 60mm

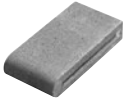

5<sup>18</sup>/<sub>16</sub> X 11<sup>13</sup>/<sub>16</sub> X 2<sup>3</sup>/<sub>8</sub>

UNIT	SQFT/ PALLET	SQFT/ LAYER	LAYER/ PALLET	UNITS/ PALLET	SQFT/ UNITS	WEIGHT/ UNIT	WEIGHT/ PALLET
60mm							
5 <sup>18</sup> / <sub>16</sub> X 11 <sup>13</sup> / <sub>16</sub> X 2 <sup>3</sup> / <sub>8</sub>	97.5 LF	2.5 LF	5	195	.5 LF	-	2555

# MARINA COPING - POOL INSTALLATION

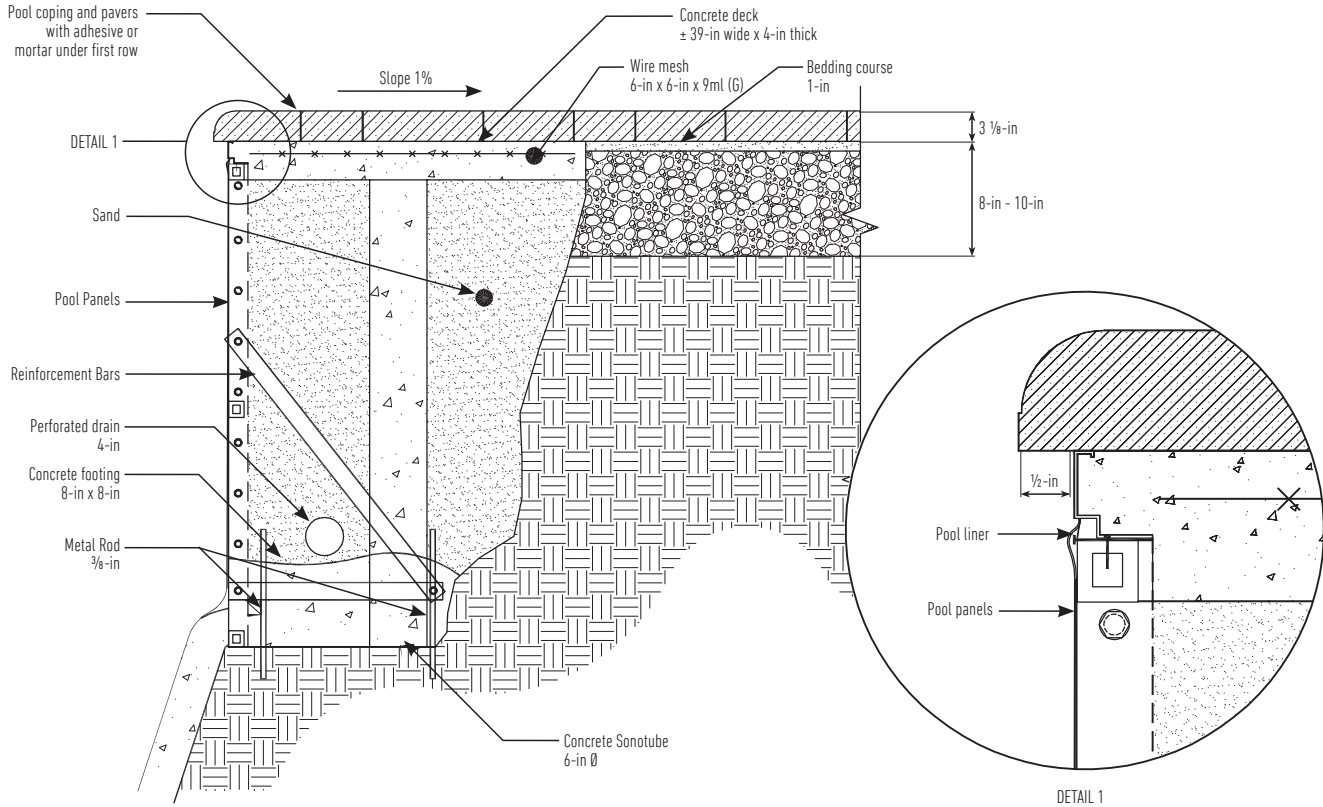

# MARINA COPING - STEP INSTALLATION

## OPTION 1

- A. Marina Coping
- B. Wall Block
- C. Grey block (4 in x 8 in x 16 in) or Wall Block

Note: All elements must be glued together with the concrete adhesive

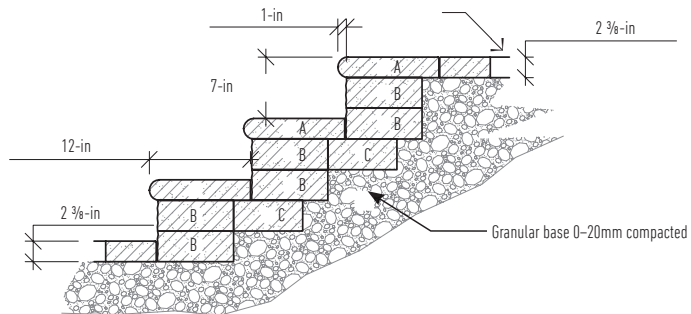

## OPTION 2

- A. Marina Coping
- B. Wall Block

Note: A & B elements must be glued together with the concrete adhesive.

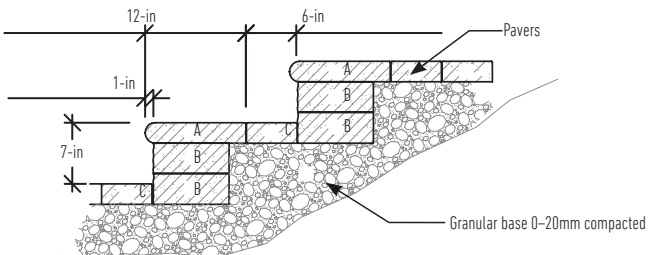

# BELGARD® | PAVES THE WAY™

**OLDCASTLE APG GREAT LAKES**  
901 E. Troy Ave.  
Indianapolis, IN 46203  
Ph: 800-424-0190

6045 Dixie Highway,  
Bridgeport, MI 48722  
Ph: 800-424-0190

5190 Oster Rd.,  
Sheffield Village, OH 44054  
Ph: 440-949-1167  
National Ph: 877-235-4273

## STAY CONNECTED WITH BELGARD.



[Pinterest.com/Belgard](https://www.pinterest.com/Belgard)



[Facebook.com/OutdoorLivingbyBelgard](https://www.facebook.com/OutdoorLivingbyBelgard)



[Belgard.com/Blog](https://www.belgard.com/blog)



[YouTube.com/BelgardHardscapes](https://www.youtube.com/BelgardHardscapes)



[Twitter.com/Belgard](https://twitter.com/Belgard)



[Instagram.com/BelgardOutdoorLiving](https://www.instagram.com/BelgardOutdoorLiving)