

2017 **hardscapes** product guide

specifications • packaging • color selector



**Rochester**  
Concrete Products™

Our (new) mesh protector between paver layers eliminates scuff marks and dust during transport.



**KolorLast**<sup>™</sup>  
Hardscape Protectant

Our (new) KolorLast protectant is applied in the manufacturing process, creating a molecular bond with concrete to unlock the natural beauty of pavers while improving colorfastness and resistance to acid rain and staining.

See the KolorLast difference at [www.rochesterpcp.com/kolorlast](http://www.rochesterpcp.com/kolorlast)

## landscape tiles

Antique Travertine Landscape Tiles . . . . .	23
Barn Plank Landscape Tiles . . . . .	25
Classic Travertine Landscape Tiles . . . . .	26
Patio Decking . . . . .	27
Slate Landscape Tiles . . . . .	24

## pavers & slabs

Barrington Paver . . . . .	31
Broadmour Pavers . . . . .	33
Cobble Stone Paver . . . . .	36
Colonial Paver/Circle Kit . . . . .	37-38
Dynasty Slab . . . . .	27
Holland Eco Paver . . . . .	43
Fieldstone Paver . . . . .	42
Flagstone Paver . . . . .	36
Heartland Paver . . . . .	42
Holland . . . . .	39
Lamont Paver/Circle Kit . . . . .	34-35
Mezzano Paver . . . . .	29
Minnetonka Paver . . . . .	28
Navarro Paver . . . . .	30
Pedestal/Ballast Pavers . . . . .	27
Serano Paver . . . . .	32
Turfstone Eco paver . . . . .	43
Victorian Paver/Circle Kit . . . . .	40-41

## retaining walls

Belvedere Wall and Fire Ring . . . . .	54-55
Classic 6 and 8 Walls . . . . .	51
Classic 8 Chiseled Face Wall . . . . .	50
Classic Colonial 6 and 8 Walls . . . . .	50
Compac and Hewnstone Walls & Pins . . . . .	58-59
Cottage Stone Wall . . . . .	60
Country Manor Wall . . . . .	57
Dimensional Wall . . . . .	57
Kodah Wall . . . . .	53
Lakeland and Riverland Walls . . . . .	49
Legend Wall . . . . .	51
Monument HD Wall . . . . .	52
Outcropping Wall . . . . .	56
Premier 8 Wall . . . . .	53
Recon Walls . . . . .	61
Sapphire Wall . . . . .	52
StackStone/RomanStack Walls . . . . .	62
Standard Wall . . . . .	59
Stonegate Country Manor . . . . .	58
StoneHedge 6 Wall . . . . .	60
Vintage 4 and 8 Walls . . . . .	45
Vintage 6 Wall . . . . .	45

## outdoor living kits

Colonial Fireplace . . . . .	68
Compact Bar . . . . .	71
Compact Fireplace . . . . .	69
Contemporary Fireplace . . . . .	67
Dining and Pub Tables . . . . .	72
Grand Fireplace . . . . .	67
Grand Fire Ring & Accessories . . . . .	70
Grand Gas Fire Ring . . . . .	70
Grand Island Bar Series . . . . .	71
Oak Gas Log Set (Fireplaces) . . . . .	68
Outdoor Oven . . . . .	66
Pillars and Seat Walls . . . . .	69
StackStone Fire Pit . . . . .	77
The Kitchen Cabinet Kits . . . . .	66
Victorian Fire Pit . . . . .	70
Victorian Fireplace . . . . .	68
Waterfalls . . . . .	72

## accessories

Adhesive . . . . .	81
Bullnose Paver . . . . .	75
Caps and Tops (Seat Wall & Pillar) . . . . .	74
Edgers . . . . .	75-76
Geo Grid/Sleeve-It . . . . .	81
Granite Paver/Wall Accent . . . . .	77
Retaining Wall Caps . . . . .	76
Sands, Cleaners & Sealers . . . . .	78-80
Snap Edge . . . . .	80
Stair Stacker . . . . .	74
Stepping Stones . . . . .	74
Steps and Treads . . . . .	73

## miscellaneous

Classic Block Wall Construction . . . . .	84-86
General Terms & Conditions . . . . .	83
Paver Materials Calculators . . . . .	44
Retaining Wall Materials Calculators . . . . .	63
Retaining Wall Grid Tables . . . . .	64-65
Vintage Block Wall Construction . . . . .	87-89
Vintage 4 & 8 Wall Patterns . . . . .	46-48
Warranty Statement . . . . .	82

Note: Product availability and specifications subject to change without notice. Certain products not available in all areas. Not responsible for errors or omissions. Refer to actual product samples when making color selection. For Product Guide updates, download electronic version at: [www.rochesterpcp.com/literature](http://www.rochesterpcp.com/literature)



**colonial** 6cm paver**desert** terra cotta/brown/buff**beechwood** brown/charcoal/buff**carmel** brown/buff**victorian** 6cm paver**beechwood** brown/charcoal/buff**rosewood** red/charcoal**antique copper** red/charcoal/buff

# pavers & slabs



moonlight gray charcoal/natural



antique copper red/charcoal/buff



(new)  
Onyx available in  
Colonial 3/4 sq.  
and rectangles,  
Lamont 6 x 8 & 4 x 8's  
and Granite Paver.

The screenshot shows the 'Project Details' section of the online estimator. It includes the following fields and options:

- Project Name:** A text input field with the placeholder 'Enter a name for your project'.
- Length Restrained (Lineal Ft):** A text input field with the placeholder 'Area of project to be restrained by a paver restraint product like Snap Edge. If none, leave blank.'
- \*Project Type:** Radio button options for Driveway (selected), Patio, Pool Deck, and Sidewalk/Path.
- \*Base Rock (Inches):** A text input field with the value '10' and a note: 'Quantity shown is based on ICPI suggested amounts for your project. You may require more or less. Adjust at your own risk.'
- \*Square footage:** A text input field with the placeholder 'Total square footage of the project including borders and accents for the calculation.'
- \*Waste Overage (%):** A text input field with the value '5' and a note: 'We recommend 5% of waste overage to account for damaged product or non-linear patio or walkway designs.'
- Project Description:** A large text area for additional project information.
- GET STARTED** button at the bottom right.

(new)  
Paver and wall **online calculator.**

Quickly estimate hardscapes, edging, sand, caps and adhesive—and it's mobile friendly.

[rochestercp.com/estimator](http://rochestercp.com/estimator)



**mezzano** 6cm paver • new color **bluestone** • accent pavers = **brown, buff, onyx**



**beechwood** brown/charcoal/buff



**antique brown** brown/charcoal/desert buff



**sierra gray** charcoal/desert buff

**minnetonka** 6cm paver • new color **antique copper**



**beechwood** brown/charcoal/buff

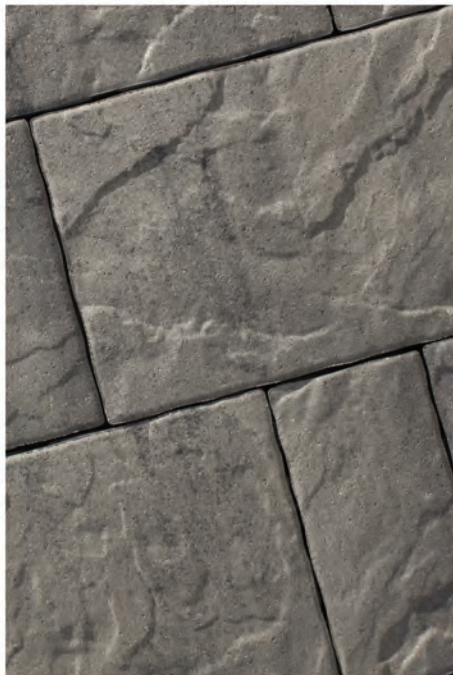

**cascade** gray/charcoal



**santa fe** gray/sandstone/brown

# pavers & slabs



**santa fe** gray/sandstone/brown



**cascade** gray/charcoal



## flagstone 6cm paver



**antique brown** brown/charcoal/desert buff



**santa fe** gray/sandstone/brown



**sierra gray** charcoal/desert buff

**serano** 6cm paver • accent pavers = **brown, buff, onyx****beechwood** brown/charcoal/buff**bluestone** gray/brown/charcoal**antique brown** brown/charcoal/desert buff**barrington** 6cm paver • new color **antique copper****beechwood** brown/charcoal/buff**cascade** gray/charcoal**santa fe** gray/sandstone/brown



# pavers & slabs

## broadmour & plank



**santa fe** gray/sandstone/brown



**cascade** gray/charcoal



**cascade** gray/charcoal

## broadmour & plank 10cm paver

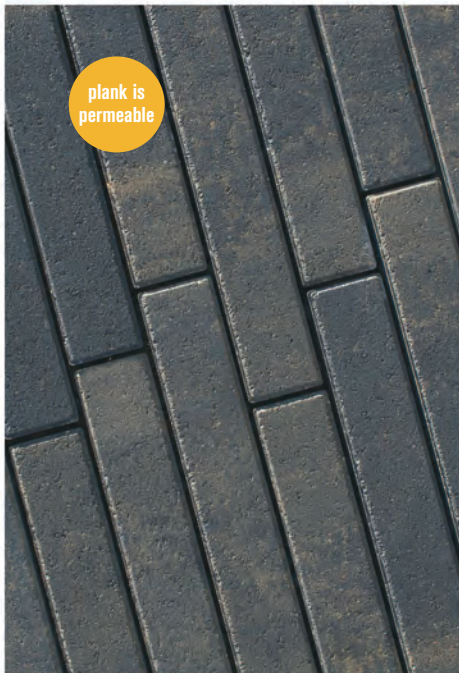

**sierra gray** charcoal/desert buff



**santa fe** gray/sandstone/brown



**beechwood** brown/charcoal/buff

**lamont** 6cm paver • onyx, brown, desert buff in 6 x 8" and 4 x 8's



**beechwood** brown/charcoal/buff



**antique brown** brown/charcoal/desert buff



**santa fe** gray/sandstone/brown

**cobble stone** 8cm paver



**moonlight gray** charcoal/natural



**beechwood** brown/charcoal/buff

# pavers & slabs



**desert buff** light buff



**sierra gray** charcoal/desert buff



**sierra gray** charcoal/desert buff



**onyx** dark charcoal

**holland** 6cm pavers

---



**antique copper** red/charcoal/buff



**beechwood** brown/charcoal/buff



**moonlight gray** charcoal/natural



**rosewood** red/charcoal



**carmel** brown/buff



**desert** terra cotta/brown/buff

**holland** 8cm pavers available in buff, charcoal (not shown)

# pavers & slabs

## navarro 8cm pavers



**beechwood** brown/charcoal/buff



**antique brown** brown/charcoal/desert buff

## holland eco 8cm pavers

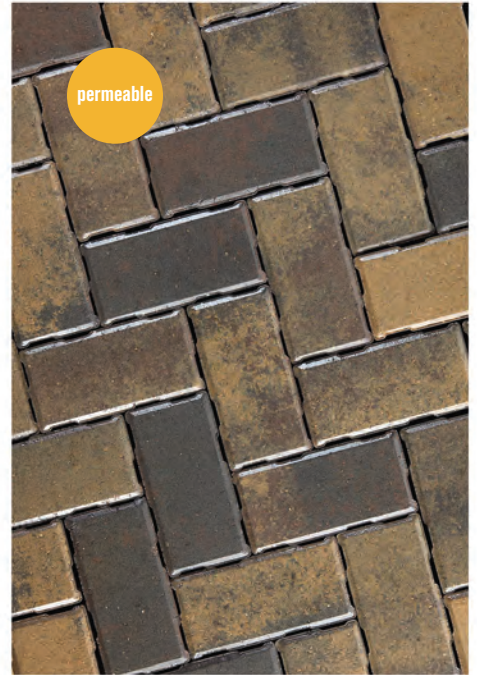

**beechwood** brown/charcoal/buff



**santa fe** gray/sandstone/brown



**sierra gray** charcoal/desert buff



**carmel** brown/buff



**slate** landscape tiles



**bluestone** charcoal/light charcoal/gray



**fond du lac** gray/charcoal/sandstone

**barn plank** landscape tiles

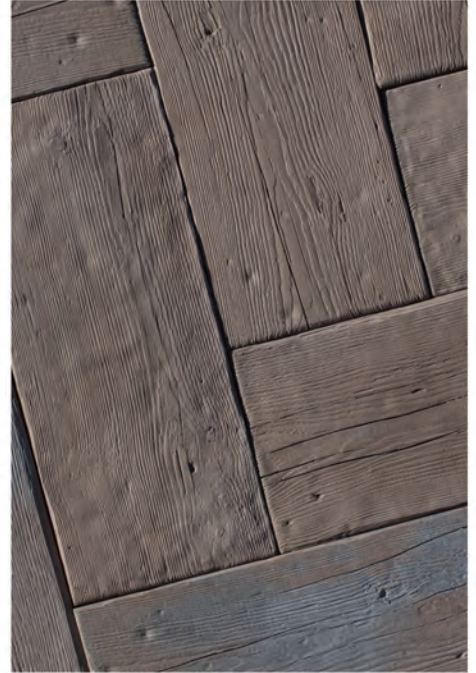

**espresso** brown/charcoal

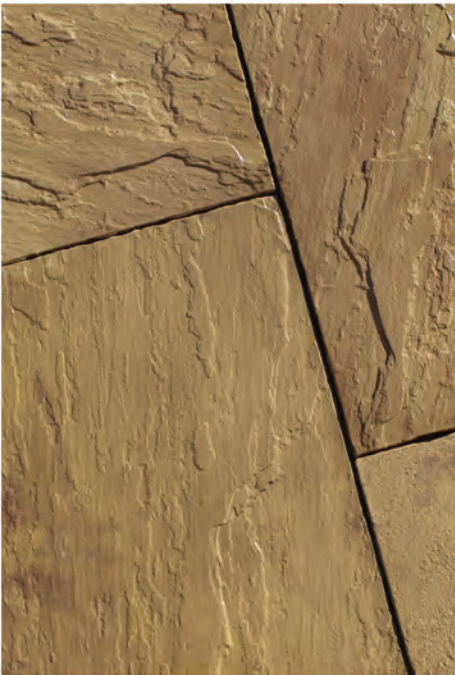

**western buff** sandstone/brown



**cream** white/sandstone



**cedar** tan/brown

# landscape tiles, caps & tops

**antique** travertine



**ivory** white cement



**graphite** dark gray

**stepping** stones



**fond du lac** gray/charcoal/sandstone

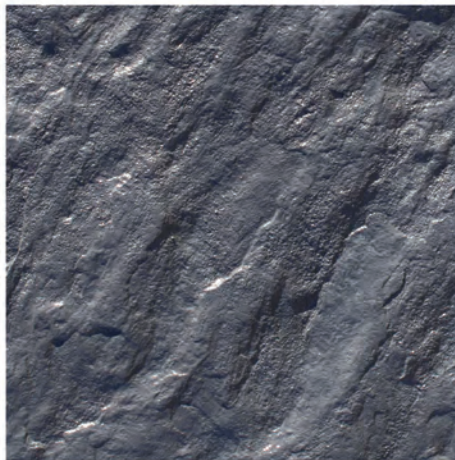

**bluestone** charcoal/light charcoal/gray



**western buff** sandstone/brown

**seat wall/pillar caps**



**bluestone** charcoal/light charcoal/gray



**western buff** sandstone/brown



**indiana limestone** gray

**lakeland & riverland walls**



**bluestone** gray/brown/charcoal



**santa fe** gray/sandstone/brown



**onyx** dark charcoal



**beechwood** brown/charcoal/buff



**desert** sandstone/blush/brown

**vintage 6 wall** • new color **bluestone**



**santa fe** gray/sandstone/brown



**beechwood** brown/charcoal/buff



**desert buff**

**vintage 8 & 4 walls**



**bluestone** gray/brown/charcoal



**desert** sandstone/blush/brown



**santa fe** gray/sandstone/brown



# retaining walls

## classic 6 & 8 walls • see page 51 for available colors



**santa fe** gray/sandstone/brown



**sandstone brown** sandstone/brown



**bluestone** gray/brown/charcoal



**sandstone**



**brown**



**charcoal**



**gray**

## legend wall

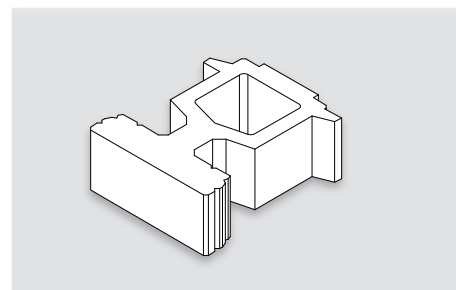

**gray or sandstone**

## sapphire wall

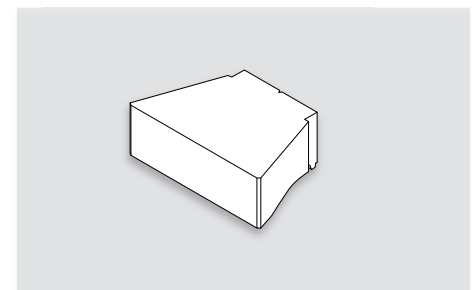

**beechwood** brown/charcoal/buff  
**santa fe** gray/sandstone/brown  
**sandstone**

## classic colonial wall



**bluestone** gray/brown/charcoal



**santa fe** gray/sandstone/brown



**sandstone brown** sandstone/brown

**cottage stone wall**



**sandstone**



**sandstone brown** sandstone/brown



**brown**



**charcoal**



**gray**

**stonehedge 6 wall**



**sandstone**



**santa fe** gray/sandstone/brown



**santa fe** gray/sandstone/brown



**bluestone** gray/brown/charcoal



**sandstone brown** sandstone/brown



**bluestone** gray/brown/charcoal

**limestone gray** (not shown)

**chiseled face wall**

# retaining walls

## belvedere, kodah & outcropping walls



**copper canyon**



**fond du lac**



**pacific gray**

## country manor wall

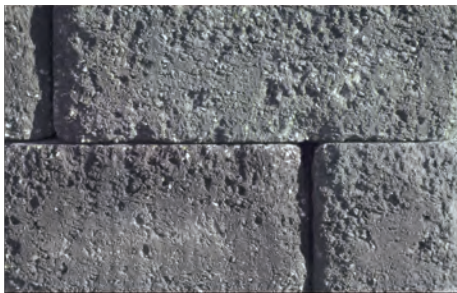

**bluestone** gray/brown/charcoal



**santa fe** gray/sandstone/brown



**beechwood** brown/charcoal/buff

## stonegate country manor wall

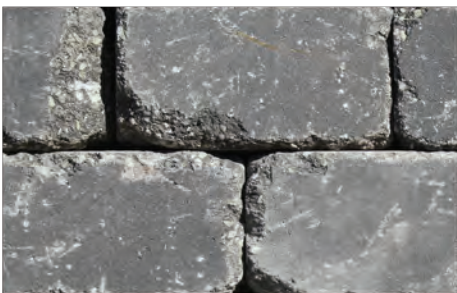

**bluestone** gray/brown/charcoal



**santa fe** gray/sandstone/brown



**beechwood** brown/charcoal/buff





# ***Rochester*** Concrete Products™

Manufacturers and distributors of quality hardscape products and supplies



# product updates

## new products

- Mezzano paver accent
- Serrano paver accent
- Broadmour paver sizes
  - 17 x 35" and 35 x 35"
- KolorLast paver treatment
- Lakeland Large Non-Tumbled
- Sapphire retaining wall
- Premier 8 retaining wall
- Grand Island Bar and Grill Series updates
  - Summerset Sizzler Grill
  - 30 x 30" Stainless Steel Doors
- Outdoor Oven Tool Set
- Grand Canyon Gas Log Set
- 3" Split Face Cap
- Online Product Calculator

Note: New products and colors will be made as soon as the weather permits, call for availability.

## new colors

- Antique Copper
  - Barrington
  - Minnetonka
- Bluestone
  - Mezzano
  - Vintage 6
- Cascade
  - Broadmour
- Onyx
  - Bullnose
  - Lakeland
  - Riverland
  - Granite paver
  - Granite wall accent
  - Colonial ¾ square and rectangle
  - Serrano accent
  - Mezzano accent
  - Holland 6 cm
- Desert Buff
  - Vintage 6
  - Colonial ¾ square and rectangle

## discontinued items

- 20 x 16" & 24 x 24" Stainless Steel Door
- 6" Step Tread
- Belvedere Pillar Kit
- Classic 6 in Brown and Monterey
- Classic 6 Eco
- Classic Colonial in Monterey
- Classic Travertine
- Colonial paver in Antique Brown
- Dimensional Wall
- Dynasty
- Fieldstone paver
- Heartland paver
- RomanStack
- Vermont Castings Grills

Note: Products are available while supplies last, call for availability.

# planning your order

## product data

All dimensions are nominal and in inches; weights are in pounds.

## stacking pallets

The following items can stack on top of other pallets but **CANNOT** be stacked upon due to pallet size and/or position of product on pallet:

- Travertine 18 x 18, 24 x 18, and 14 x 14 bullnose
- Antique Travertine: 24 x 18, 24 x 24, and 24 x 12 bullnose
- Slate in 18 X 18, 24 X 24, 24 x 36, and 14 x 14 bullnose
- Fire Ring Cap
- Cottage Stone
- Stepping Stones

## loading notes

- Grand Fire Ring Kits can be stacked up to three high
- For LTL purposes, each "spot" cannot weigh over 3,000 lbs. stacked
- Weight per pallet includes 50 lbs. for pallets

## freight rates

Whether shipping LTL or full loads, dispatchers will find the most competitive freight rate available. Contact dispatch at the location your order is shipping from to request a quote.

Do you need a few pallets to complete a job but can't wait for a full truckload order? Dispatchers will work to get what you need shipped quickly via LTL carrier. LTL shipments less than 15,000 lbs. and 10 pallets are shipped at current rates throughout the Midwest at 1-3 day delivery.

## staff

<b>Sales Rep</b>	<b>Region</b>	<b>Cell Phone</b>	<b>Email</b>
Scott Gengler	IA, NE	507-269-6982	scott.gengler@rochesterpcp.com
Kurt Glave	IL, IN	847-401-3741	kurt.glave@rochesterpcp.com
Crystal Kjellesvik	IL	630-400-4988	crystal.kjellesvik@rochesterpcp.com
Glen Nevala	MN, SD, ND	612-702-4115	glen.nevala@rochesterpcp.com
Jeremy Bickner	MN	612-916-7449	jeremy.bickner@rochesterpcp.com
Travis Lawrence	MN	612-801-9026	travis.lawrence@rochesterpcp.com
Debra Hyde	WI	507-254-4116	debra.hyde@rochesterpcp.com
John Sheahan	WI	507-279-2950	john.sheahan@rochesterpcp.com
Chad Peterson	WI	262-758-2354	chad.peterson@rochesterpcp.com
Jim Weidner	Inside Sales	507-951-4374	jim.weidner@rochesterpcp.com

<b>Dispatch</b>	<b>Location</b>	<b>Office Phone</b>	<b>Email</b>
Tammy Weiss	Beaver Dam	920-386-3105	tammy.weiss@rochesterpcp.com
Cherey Justmann	Beaver Dam	920-386-3104	cherey.justmann@rochesterpcp.com
Mark Straub	Jordan	952-492-3636	mark.straub@rochesterpcp.com
September Stender	Jordan	952-492-3636	september.stender@rochesterpcp.com
Jaime Martinez	Rochester	507-424-4693	jaime.martinez@rochesterpcp.com
Tanya Kapfer	Thorp	715-669-5552	tanya.kapfer@rochesterpcp.com

<b>Support Staff</b>	<b>Job</b>	<b>Office Phone</b>	<b>Email</b>
David Spies	Marketing Director	507-535-3507	david.spies@rochesterpcp.com
Cathy Haggerty	Event Director	507-535-3501	cathy.haggerty@rochesterpcp.com
Brittany Hollenbeck	Marketing Manager	507-535-3519	brittany.hollenbeck@rochesterpcp.com
Lindsay Birr	Merchandise Manager	507-535-3512	lindsay.birr@rochesterpcp.com
Jessica Hepinstall	Fulfillment Coordinator	507-535-3500	jessica.hepinstall@rochesterpcp.com
Becky Erdman	Warranty/Sample Coordinator	507-535-1480	becky.erdman@rochesterpcp.com

## locations

<b>Plants</b>	<b>Address</b>	<b>City, State, Zip</b>	<b>Phone</b>	<b>Fax</b>
Rochester	7200 North Broadway Ave	Rochester, MN 55906	507-288-8850	507-424-4697
Beaver Dam	W6558 Hwy 33	Juneau, WI 53039	920-386-3333	920-386-4612
Thorp	N14665 Dickerson Ave	Thorp, WI 54771	715-669-5552	715-669-7135
Jordan	3535 Bluff Drive	Jordan, MN 55352	952-492-3636	952-492-3668

# antique travertine landscape tiles

Silver Creek Stoneworks

## Features

- Three sizes, ea. with eighteen unique faces
- Radius edges for no-gap installation
- Strong and durable 10,000 psi concrete

## Colors

- Graphite
- Ivory

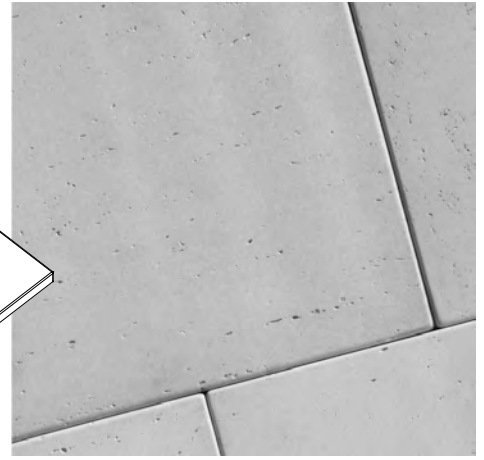
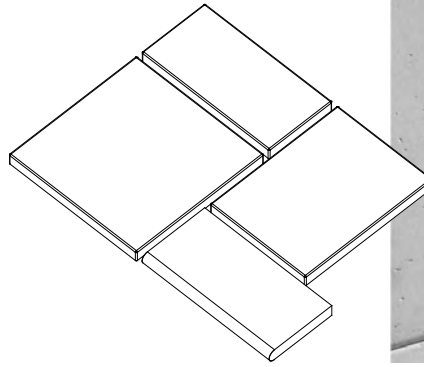

Name	Size	Face Area	Weight	Units/Pallet	Pallet	Pallet Weight
	24 x 12 x 2" H	2 sq. ft.	46 lbs.	20	40 sq. ft.	970 lbs.
	24 x 18 x 2" H	3 sq. ft.	70 lbs.	20	60 sq. ft.	1,450 lbs.
	24 x 24 x 2" H	4 sq. ft.	88 lbs.	20	80 sq. ft.	1,810 lbs.
bullnose	24 x 12 x 2" H	2 sq. ft.	43 lbs.	20	40 sq. ft.	910 lbs.

**Notes:** Partial pallet quantities available. Special color runs available with set-up fee, minimum quantities apply. Customer must take 100% of product run. **Special note:** 24 x 18, 24 x 24, and 24 x 12 bullnose CANNOT be double stacked.

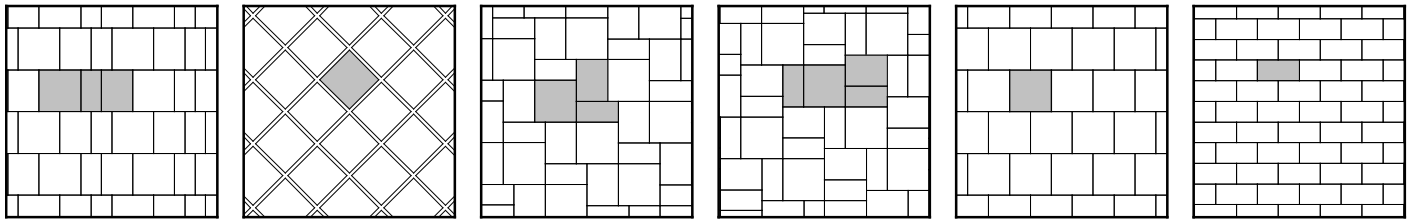

Size	Pattern 1	Pattern 2	Pattern 3	Pattern 4	Pattern 5	Pattern 6
24 x 12 x 2" H	22.2%		22.2%	36.2%		100%
Ratio	1		1	2		
24 x 18 x 2" H	33.3%		33.3%	27.3%		
Ratio	1		1	1		
24 x 24 x 2" H	44.4%	100%	44.4%	36.5%	100%	
Ratio	1		1	1		

# slate landscape tiles

Silver Creek Stoneworks

## Features

- Five sizes with twenty-seven unique faces
- 24 x 36" size creates greater scalability
- Strong and durable 10,000 psi concrete

## Colors

- Bluestone
- Cream
- Fond du Lac
- Western Buff

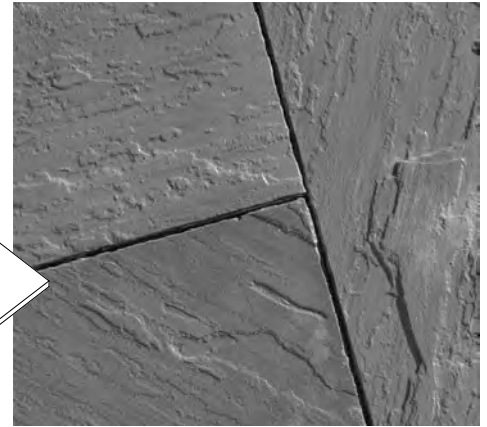
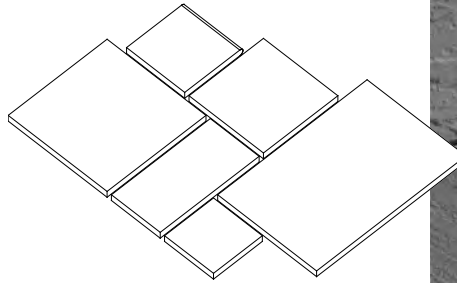

Name	Size	Face Area	Weight	Units/Pallet	Pallet	Pallet Weight
	12 x 12 x 1.5" H	1 sq. ft.	19 lbs.	48	48 sq. ft.	938 lbs.
	18 x 18 x 1.5" H	2.25 sq. ft.	43 lbs.	24	54 sq. ft.	1,082 lbs.
	24 x 12 x 1.5" H	2 sq. ft.	38 lbs.	24	48 sq. ft.	962 lbs.
	24 x 24 x 1.5" H	4 sq. ft.	77 lbs.	24	96 sq. ft.	1,898 lbs.
	24 x 36 x 1.5" H	6 sq. ft.	106 lbs.	16	96 sq. ft.	1,746 lbs.
bullnose	14 x 14 x 1.5" H	1.36 sq. ft.	25 lbs.	24	32.66 sq. ft.	650 lbs.

**Notes:** Partial pallet quantities available. Special color runs available with set-up fee, minimum quantities apply. Customer must take 100% of product run. Use a buffer pad between the plate compactor and surface to prevent scuffing.

**Special note:** 18 x 18, 24 x 24, 24 x 36, and 14 x 14 bullnose CANNOT be double stacked.

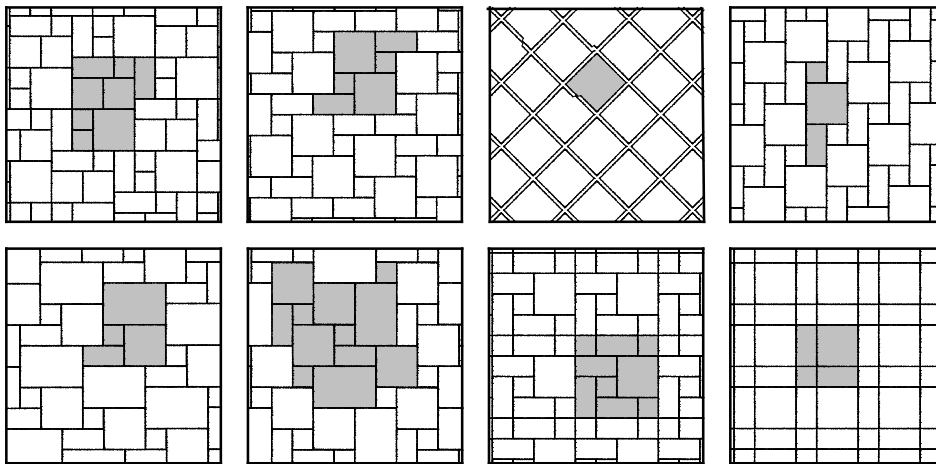

Size	Pattern 1	Pattern 2	Pattern 3	Pattern 4	Pattern 5	Pattern 6 - Largo	Pattern 7	Pattern 8
12 x 12	19%	14%		14%	7.69%	11.1%	25%	11.2%
Ratio	3	2		1	1	4	4	1
18 x 18	29%							
Ratio	2							
24 x 12	26%	29%		29%	15.39%	11.1%	50%	44.4%
Ratio	2	2		1	1	2	4	2
24 x 24	26%	57%	100%	57%	30.77%	44.4%	25%	44.4%
Ratio	1	2		1	1	4	1	1
24 x 36					46.15%	33.3%		
Ratio					1	2		



# barn plank landscape tiles

Silver Creek Stoneworks

## Features

- Three sizes, ea. with three unique faces
- Will never rot or warp
- Deep splits and detailed grain top and sides

## Colors

- Cedar
- Espresso

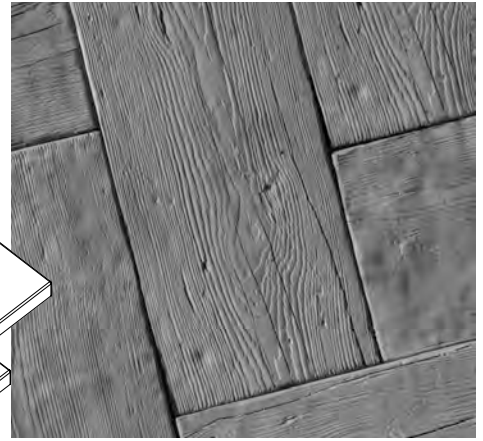
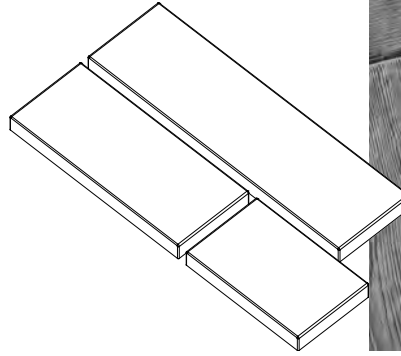

Name	Size	Face Area	Weight	Units/Pallet	Pallet	Pallet Weight
Small	15.50 x 9.75 x 2" H	1.05 sq. ft.	24 lbs.	40	42 sq. ft.	1,010 lbs.
Medium	23.375 x 9.75 x 2" H	1.59 sq. ft.	33 lbs.	20	31.80 sq. ft.	710 lbs.
Large	35 x 9.75 x 2" H	2.37 sq. ft.	52 lbs.	20	47.40 sq. ft.	1,090 lbs.

**Notes:** Partial pallet quantities available. To calculate pieces divide total sq. ft. by 5.20.

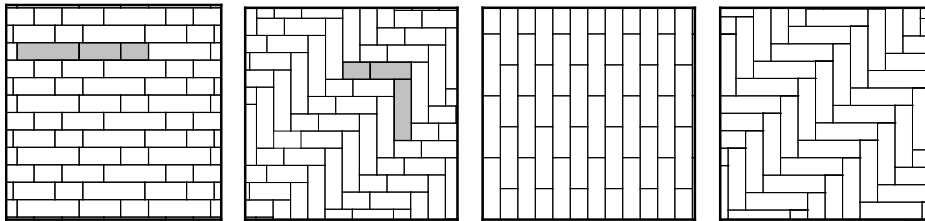

Name	Pattern 1	Pattern 2	Pattern 3	Pattern 4
Small	20.9%	14.2%		
Ratio	1	1		
Medium	31.6%	21.5%		
Ratio	1	1		
Large	47.4%	64.3%	100%	100%
Ratio	1	1		

# classic travertine landscape tiles

Silver Creek Stoneworks

## Features

- Three shapes with eighteen unique faces
- 90° edges create classic appearance
- Strong and durable 10,000 psi concrete

## Colors

- Graphite
- Ivory



Name	Size	Face Area	Weight	Units/Pallet	Pallet	Pallet Weight
Small	18 x 12 x 1.5" H	1.5 sq. ft.	28 lbs.	48	72 sq. ft.	1,394 lbs.
Medium	18 x 18 x 1.5" H	2.25 sq. ft.	42 lbs.	24	54 sq. ft.	1,058 lbs.
Large	24 x 18 x 1.5" H	3 sq. ft.	58 lbs.	24	72 sq. ft.	1,442 lbs.
Bullnose	14 x 14 x 1.5" H	1.36 sq. ft.	25 lbs.	24	32.64 sq. ft.	650 lbs.

**Notes:** Discontinued, available while supplies last. Call for availability. **Important installation note:** use extra care when leveling Travertine, ¼" or greater spacing is recommended because Travertine does not have a beveled edge. Use a buffer pad between the plate compactor and surface to prevent scuffing. **Special note:** 18 x 18, 24 x 18, and 14 x 14 bullnose CANNOT be double stacked.

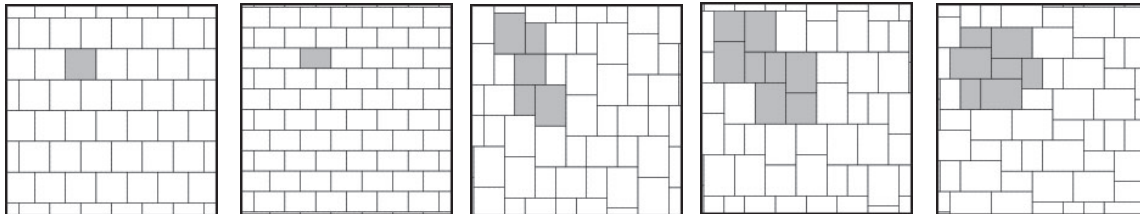

Name	Pattern 1	Pattern 2	Pattern 3	Pattern 4	Pattern 5
Small		100%	27%	15%	40%
Ratio			2	2	4
Medium	100%		20%	23%	
Ratio			1	2	
Large			53%	62%	60%
Ratio			2	4	3

# decking applications

Silver Creek Stoneworks and Interlock Concrete Products

Name	Size	Face Area	Weight	Units/Pallet	Pallet	Pallet Weight
Silver Creek Slate Pedestal Paver*	24 x 24 x 1.875" H	4	80	20	80 sq. ft.	1,650 lbs.
Diamond Face Slab Ballast Paver**	24 x 24 x 1.75" H	4	90	25	100 sq. ft.	2,300 lbs.

**Notes:** \*Special order, lead-time is required. \*\*Gray only. Available by pallet.

## dynasty slabs

Interlock Concrete Products

### Colors

- Charcoal
- Mahogany
- Mocca
- Sierra

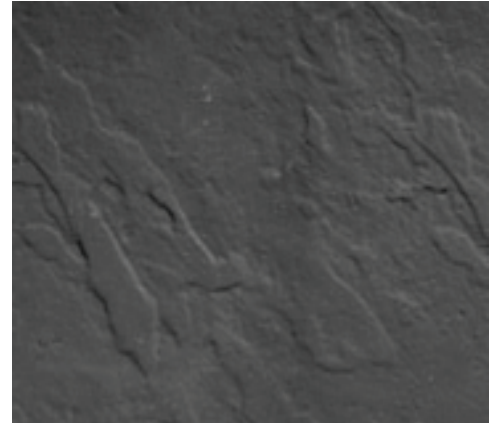

Name	Size	Face Area	Weight	Units/Bands	Bands/Pallet	Units/Pallet	Pallet	Pallet Weight
Slate	15.75 x 15.75 x 1.75" H	1.72 sq. ft.	38 lbs.	20	2	38	68.8 sq. ft.	1,570 lbs.
Slate	15.75 x 23.625 x 1.75" H	2.58 sq. ft.	56 lbs.	20	2	56	103.2 sq. ft.	2,290 lbs.

**Notes:** Discontinued, available while supplies last. Call for availability. Use a buffer pad between the plate compactor and surface to prevent scuffing. AWS and Bison pedestal systems available, call for details.

# minnetonka 6cm paver/slab

Interlock Concrete Products

## Features

- Three-piece, one pallet system
- Slate surface detail
- Suitable for paths, patios, pool decks
- Auto spacers, 1/8" joint
- Accent with Mezzano

## Colors

- Antique Copper
- Beechwood\*
- Cascade\*
- Santa Fe\*

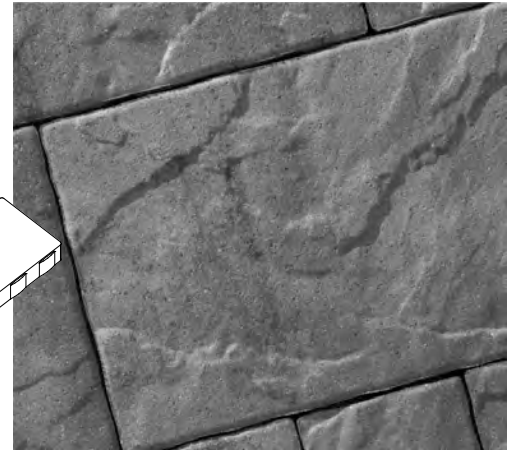
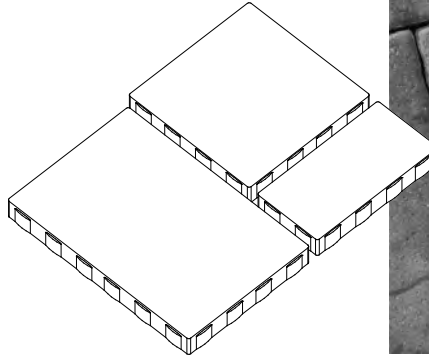

\*Available with or without KolorLast treatment.

Name	Size	Face Area	Weight	Units/Layer	Layer	Layers	Units/Pallet	Pallet	Pallet Weight
Small	8 x 16 x 2.375" H	0.89 sq. ft.	24.5 lbs.	2			20		
Medium	16 x 16 x 2.375" H	1.78 sq. ft.	49 lbs.	2	10.2 sq. ft.	10	20	102 sq. ft.	3,000 lbs.
Large	16 x 24 x 2.375" H	2.67 sq. ft.	73.5 lbs.	2			20		

**Notes:** Available by pallet or layer.

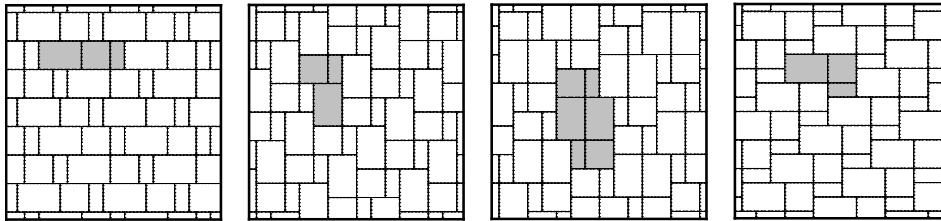

Name	Pattern 1	Pattern 2	Pattern 3	Pattern 4
Small	16.6%	16.6%	16.6%	16.6%
Medium	33.33%	33.33%	33.33%	33.33%
Large	50.07%	50.07%	50.07%	50.07%



KolorLast is applied in the manufacturing process, creating a molecular bond with concrete to unlock the natural beauty of pavers while improving colorfastness and resistance to acid rain and staining.

# mezzano 6cm paver

Interlock Concrete Products

## Features

- Three-piece, one pallet system
- Slate surface texture
- Auto spacers, 1/8" joint
- Suitable for vehicular applications
- New Accent paver

## Colors

- Antique Brown
- Beechwood\*
- Bluestone
- Cascade\*
- Santa Fe\*
- Sierra Gray

## Additional Accent Colors

- Buff
- Brown
- Onyx\*

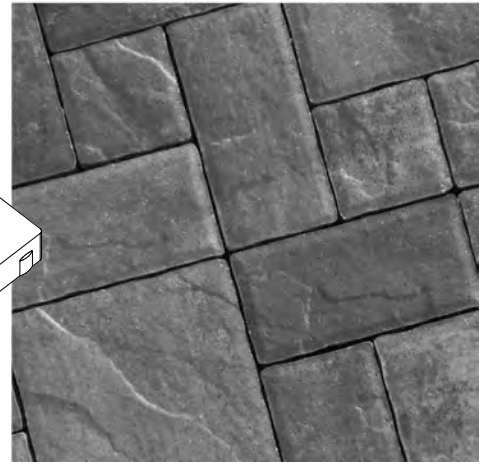
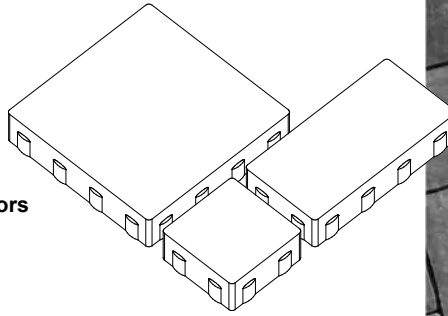

\*Available with or without KolorLast treatment.

Name	Size	Face Area	Weight	Units/Layer	Layer	Layers	Units/Pallet	Pallet	Pallet Weight
Small	5.75 x 5.75 x 2.375" H	0.23 sq. ft.	6 lbs.	6	1.38 sq. ft.		60		
Medium	5.75 x 11.5 x 2.375" H	0.46 sq. ft.	13 lbs.	6	2.76 sq. ft.	10	60	97 sq. ft.	2,685 lbs.
Large	11.5 x 11.5 x 2.375" H	0.92 sq. ft.	25 lbs.	6	5.52 sq. ft.		60		
Accent	5.75 x 11.5 x 2.375" H	0.46 sq. ft.	13 lbs.	21	9.66 sq. ft.	10	210	96.6 sq. ft.	2,780 lbs.

**NEW**

**Notes:** Available by pallet or layer. Pallet and Layer are rounded up to the nearest whole number.

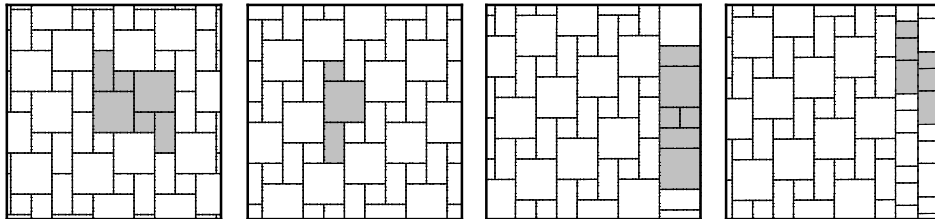

Name	Pattern 1	Pattern 2	Pattern 1 with Serano accent	Pattern 1 with Colonial accent
Small	14%	14%	14%	14%
Ratio	2	1	2	2
Medium	29%	29%	29%	29%
Ratio	2	1	2	2
Large	57%	57%	57%	57%
Ratio	2	1	2	2

**KolorLast™**  
Hardscape Protectant

# navarro 8cm paver

Interlock Concrete Products

## Features

- Three-piece, one pallet system
- Slate surface texture
- Suitable for vehicular applications

## Colors

- Antique Brown
- Beechwood
- Santa Fe
- Sierra Gray

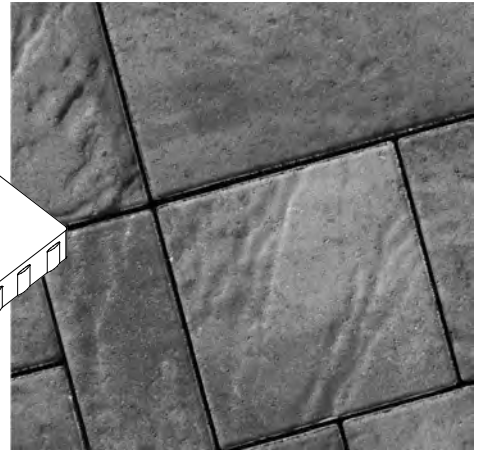
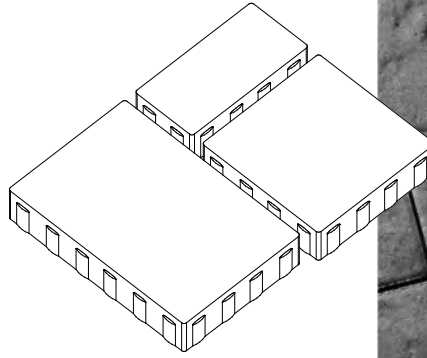

Name	Size	Face Area	Weight	Units/Layer	Layer	Layers	Units/Pallet	Pallet	Pallet Weight
Small	12 x 6 x 3.125" H	0.5 sq. ft.	19 lbs.	5	12 sq. ft.		40		
Medium	12 x 12 x 3.125" H	1.0 sq. ft.	38 lbs.	5	12 sq. ft.	8	40	96 sq. ft.	3,550 lbs.
Large	12 x 18 x 3.125" H	1.5 sq. ft.	57 lbs.	3	12 sq. ft.		24		

**Notes:** Available by pallet or layer. Special color runs available with set-up fee, minimum quantities apply. Customer must take 100% of product run.

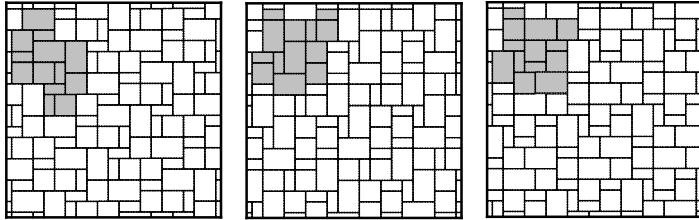

Name	Pattern 1	Pattern 2	Pattern 3
Small	20.6%	20.6%	20.6%
Ratio	5	5	5
Medium	41.7%	41.7%	41.7%
Ratio	5	5	5
Large	37.6%	37.6%	37.6%
Ratio	3	3	3

# barrington 6cm paver/slab

Interlock Concrete Products

## Features

- Three-piece, one pallet system:
- Smooth surface detail
- Suitable for paths, patios, pool decks
- Auto spacers, 1/8" joint
- Accent with Serano

## Colors

- Antique Copper
- Beechwood\*
- Cascade\*
- Santa Fe\*

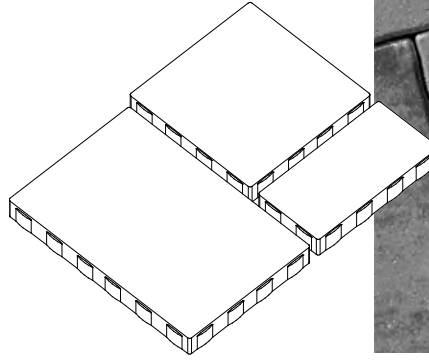

\*Available with and without KolorLast treatment.

Name	Size	Face Area	Weight	Units/Layer	Layer	Layers	Units/Pallet	Pallet	Pallet Weight
Small	8 x 16 x 2.375" H	0.89 sq. ft.	24.5 lbs.	2			20		
Medium	16 x 16 x 2.375" H	1.78 sq. ft.	49 lbs.	2	10.2 sq. ft.	10	20	102 sq. ft.	3,000 lbs.
Large	16 x 24 x 2.375" H	2.67 sq. ft.	73.5 lbs.	2			20		

**Notes:** Available by pallet or layer.

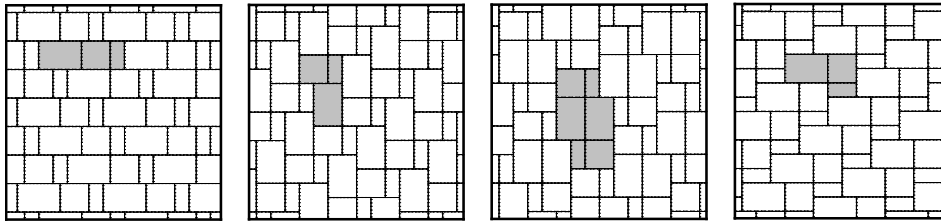

Name	Pattern 1	Pattern 2	Pattern 3	Pattern 4
Small	16.6%	16.6%	16.6%	16.6%
Medium	33.33%	33.33%	33.33%	33.33%
Large	50.07%	50.07%	50.07%	50.07%



KolorLast is applied in the manufacturing process, creating a molecular bond with concrete to unlock the natural beauty of pavers while improving colorfastness and resistance to acid rain and staining.

# serano 6cm paver

Interlock Concrete Products

## Features

- Three-piece, one pallet system
- Smooth top, contemporary style
- Auto spacers, 1/8" joint
- Suitable for vehicular applications
- New Accent paver

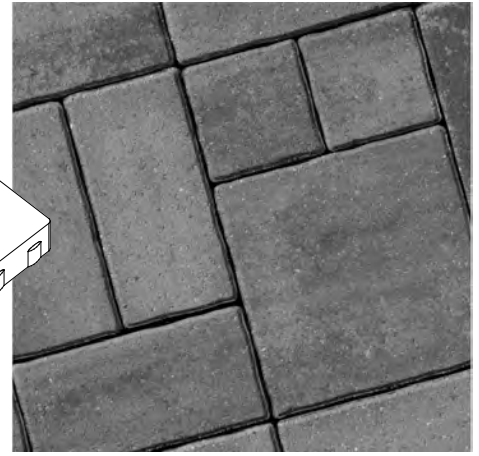
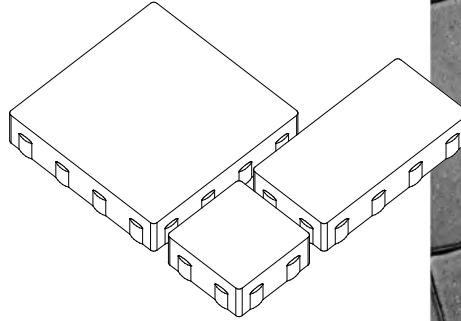

## Colors

- Antique Brown
- Beechwood\*
- Bluestone
- Cascade\*
- Santa Fe\*

## Additional Accent Colors

- Buff
- Brown
- Onyx\*

\*Available with or without KolorLast treatment.

Name	Size	Face Area	Weight	Units/Layer	Layer	Layers	Units/Pallet	Pallet	Pallet Weight
Small	5.75 x 5.75 x 2.375" H	0.23 sq. ft.	6 lbs.	6	1.38 sq. ft.		60		
Medium	5.75 x 11.5 x 2.375" H	0.46 sq. ft.	13 lbs.	6	2.76 sq. ft.	10	60	97 sq. ft.	2,685 lbs.
Large	11.5 x 11.5 x 2.375" H	0.92 sq. ft.	25 lbs.	6	5.52 sq. ft.		60		
Accent	5.75 x 11.5 x 2.375" H	0.46 sq. ft.	13 lbs.	21	9.66 sq. ft.	10	210	96.6 sq. ft.	2,780 lbs.

NEW

**Notes:** Available by pallet or layer. Pallet and Layer is rounded up to the nearest whole number.

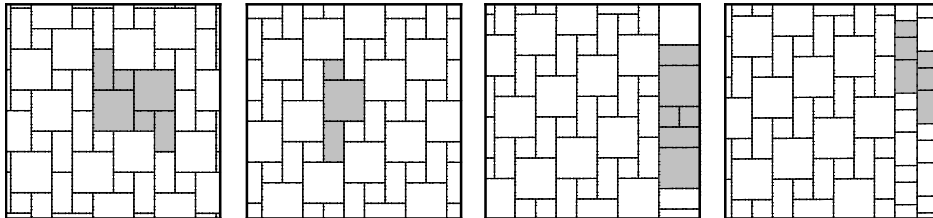

Name	Pattern 1	Pattern 2	Pattern 1 with Serano accent	Pattern 1 with Colonial accent
Small	14%	14%	14%	14%
Ratio	2	1	2	2
Medium	29%	29%	29%	29%
Ratio	2	1	2	2
Large	57%	57%	57%	57%
Ratio	2	1	2	2

**KolorLast™**  
Hardscape Protectant



# broadmour 10cm paver

Interlock Concrete Products

## Features

- Auto spacers, narrow joint
- Smooth top, contemporary style
- Plank is permeable and ideal for inset/accenting

## Colors

- Beechwood
- Cascade
- Santa Fe
- Sierra Gray

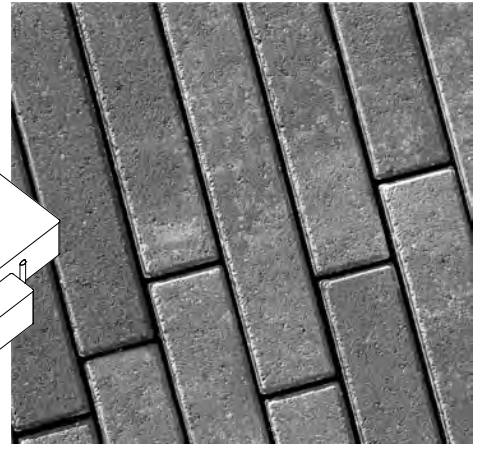
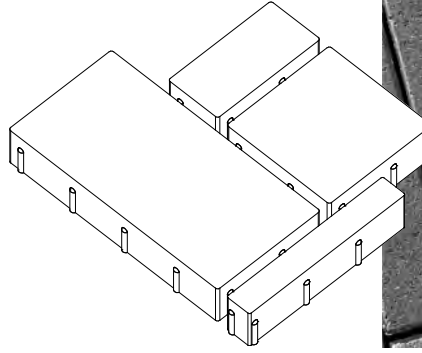

Name	Size	Face Area	Weight	Units/Layer	Layer	Layers	Units/Pallet	Pallet	Pallet Weight
Plank	18 x 3 x 4" H	0.36 sq. ft.	17.3 lbs.	22	7.92 sq. ft.	6	132	47.5 sq. ft.	2,130 lbs.
Small	6 x 12 x 4" H	0.5 sq. ft.	22.93 lbs.	15	7.17 sq. ft.	6	90	43 sq. ft.	2,050 lbs.
Medium	12 x 12 x 4" H	1.0 sq. ft.	46.22 lbs.	9	8.67 sq. ft.	6	54	52 sq. ft.	2,500 lbs.
Large	24 x 12 x 4" H	2 sq. ft.	92 lbs.	4	7.67 sq. ft.	6	24	46 sq. ft.	2,270 lbs.
X-Large*	35 x 17 x 4" H	4.33 sq. ft.	198 lbs.	6	25.98 sq. ft.	2	12	51.96 sq. ft.	2,388 lbs.
XL Square*	35 x 35 x 4" H	8.7 sq. ft.	398 ls.			1	6	51.69 sq. ft.	2,388 lbs.

NEW

**Notes:** Available by pallet or layer. \*Special order. Special color runs available with set-up fee, minimum quantities apply. Customer must take 100% of product run.

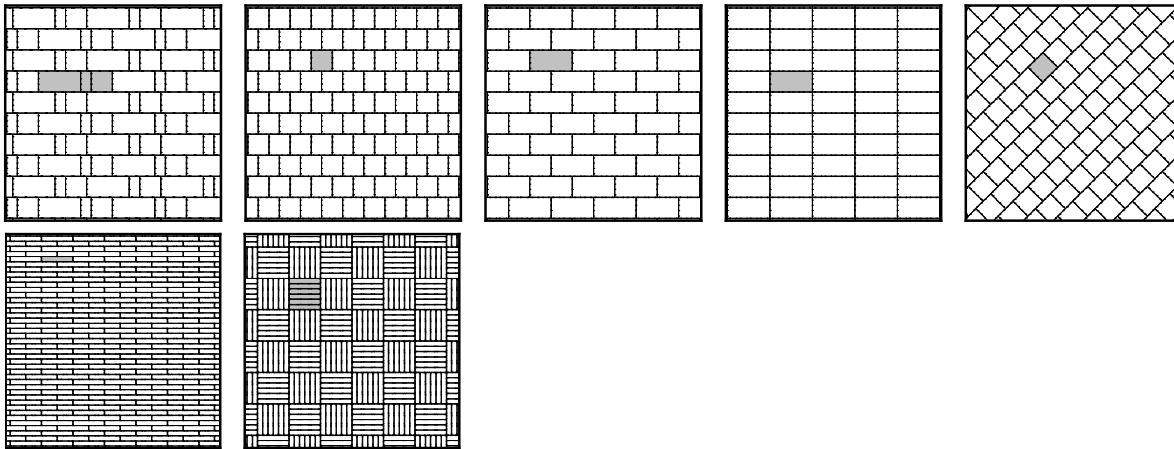

Name	Pattern 1	Pattern 2	Pattern 3	Pattern 4	Pattern 5	Pattern 6	Pattern 7
Small	14.29%	100%					
Medium	28.57%				100%		
Large	57.14%		100%	100%			
Plank						100%	100%

# Iamont 6cm paver

Interlock Concrete Products

## Features

- Four-piece tumbled system
- No auto spacers, zero joint
- Extremely versatile – endless designs
- 4x8 and 6x8 accent colors

## Colors

- Antique Brown
- Beechwood
- Desert Buff
- Santa Fe
- Sierra Gray

## Accent Colors

- Brown
- Onyx\*
- Desert Buff

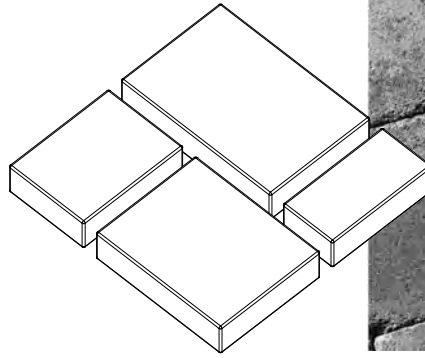

\*Available with or without KolorLast treatment.

Name	Size	Face Area	Weight	Units/Band	Band	Bands/Pallet	Units/Pallet	Pallet	Pallet Weight
4x8	4.13 x 8.25 x 2.375" H	0.24 sq. ft.	7 lbs.	80	19.2 sq. ft.	5	400	96 sq. ft.	2,625 lbs.
6x8	6.1875 x 8.25 x 2.375" H	0.35 sq. ft.	10 lbs.	50	17.8 sq. ft.	5	250	89 sq. ft.	2,450 lbs.
10x8	10.3 x 8.25 x 2.375" H	0.59 sq. ft.	17 lbs.	40	23.75 sq. ft.	4	160	95 sq. ft.	2,710 lbs.
12x8	12.375 x 8.25 x 2.375" H	0.71 sq. ft.	21 lbs.	40	28.5 sq. ft.	4	160	114 sq. ft.	3,170 lbs.

**Notes:** Available by pallet or band. Special color runs available with set-up fee, minimum quantities apply. Customer must take 100% of product run.

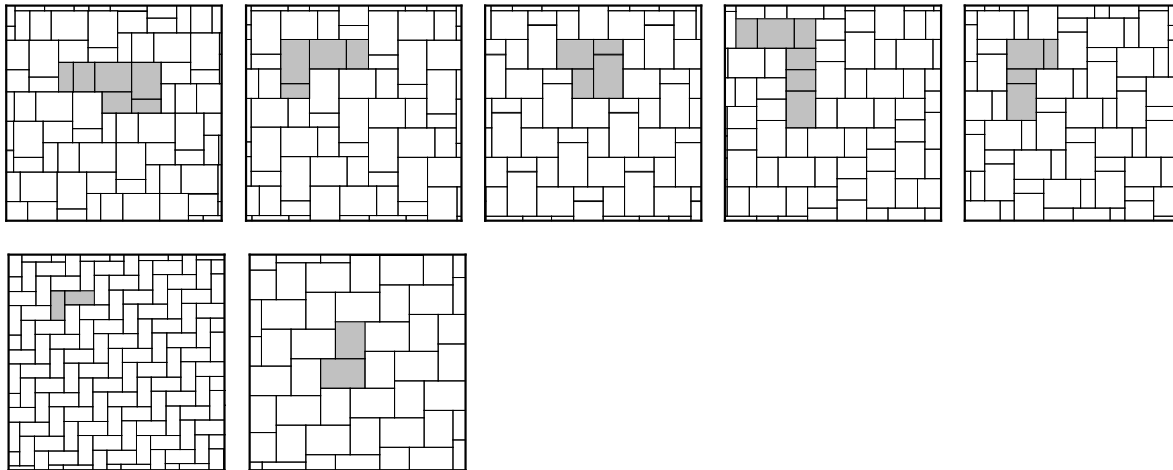

Name	Pattern 1	Pattern 2	Pattern 3	Pattern 4	Pattern 5	Pattern 6	Pattern 7
4x8	20%	12%	12%		29%	100%	
Ratio	2	1	1		2		
6x8	30%	19%	19%	45%			
Ratio	2	1	1	4			
10x8	50%	31%	31%	55%	71%		45%
Ratio	2	1	1	2	2		1
12x8		38%	38%				55%
Ratio		1	1				1

# Iamont circle 6cm paver

Interlock Concrete Products

## Features

- All on one pallet
- 10.33 ft. diameter circle
- No auto spacers, zero joint

## Colors

- Antique Brown
- Beechwood
- Desert Buff
- Santa Fe
- Sierra Gray

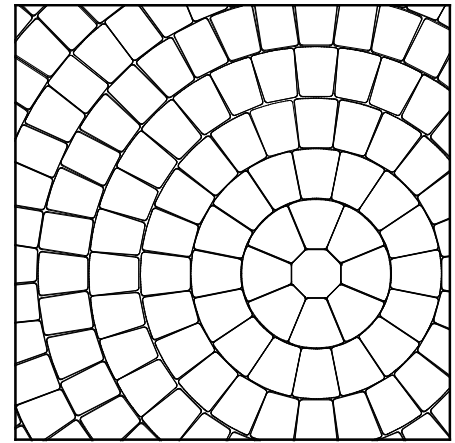

Name	Size	Face Area	Weight	Units/Pallet	Pallet	Pallet Weight
Center Piece	8.26 x 8.26 x 2.375" H	0.47 sq. ft.	13 lbs.	9		
Small Circle	9.39 x 8.26 x 2.375" H	0.54 sq. ft.	15 lbs.	9		
Middle Circle	7.97 x 8.26 x 2.375" H	0.59 sq. ft.	17 lbs.	18	89 sq. ft.	2,520 lbs.
Large Circle	7.21 x 8.26 x 2.375" H	0.41 sq. ft.	12 lbs.	135		
6 x 8	6.1875 x 8.25 x 2.375" H	0.35 sq. ft.	10 lbs.	81		

**Notes:** Sold as full pallet only. Circle bundle makes 10.33 ft. diameter.

Course No.	Outside Diameter	Outside Diameter	Area Covered	Starter Kit					6 x 8 Units	6 x 8 Pallets	6 x 8 Bands
				Center	Small	Middle	Large	6 x 8			
Center	8.26 in.	0.69 ft.	0.37 sq. ft.	1	0	0	0	0			
1	24.76 in.	2.06 ft.	3.34 sq. ft.	0	8	0	0	0			
2	41.26 in.	3.44 ft.	9.29 sq. ft.	0	0	16	0	0			
3	57.76 in.	4.81 ft.	18.20 sq. ft.	0	0	0	24	0			
4	74.26 in.	6.19 ft.	30.08 sq. ft.	0	0	0	32	0			
5	90.76 in.	7.56 ft.	44.93 sq. ft.	0	0	0	20	20			
6	107.26 in.	8.94 ft.	62.75 sq. ft.	0	0	0	24	24			
7	123.76 in.	10.31 ft.	83.54 sq. ft.	0	0	0	28	29			
8	140.11 in.	11.68 ft.	107.07 sq. ft.			1			72	2	
9	156.46 in.	13.04 ft.	133.52 sq. ft.			1			80	3	
10	172.81 in.	14.40 ft.	162.88 sq. ft.			1			88	1	
11	189.16 in.	15.76 ft.	195.16 sq. ft.			1			97	1	
12	205.51 in.	17.13 ft.	230.35 sq. ft.			1			105	1	
13	221.86 in.	18.49 ft.	268.46 sq. ft.			1			113	2	
14	238.21 in.	19.85 ft.	309.49 sq. ft.			1			122	2	
15	254.56 in.	21.21 ft.	353.43 sq. ft.			1			130	3	
16	270.91 in.	22.58 ft.	400.29 sq. ft.			1			138	3	
17	287.26 in.	23.94 ft.	450.07 sq. ft.			1			147	4	
18	303.61 in.	25.30 ft.	502.76 sq. ft.			1			155	5	
19	319.96 in.	26.66 ft.	558.37 sq. ft.			1			163	5	
20	336.31 in.	28.03 ft.	616.89 sq. ft.			1			172	6	
21	352.66 in.	29.39 ft.	678.33 sq. ft.			1			180	7	
22	369.01 in.	30.75 ft.	742.69 sq. ft.			1			189	8	

# cobble stone 8cm paver

Interlock Concrete Products

## Features

- Four-piece, one pallet system
- Wide joint; permeable or non-permeable
- Ideal companion to Navarro paver

## Colors

- Beechwood
- Moonlight Gray
- Onyx\*
- Sierra Gray

\*Available with or without KolorLast treatment.

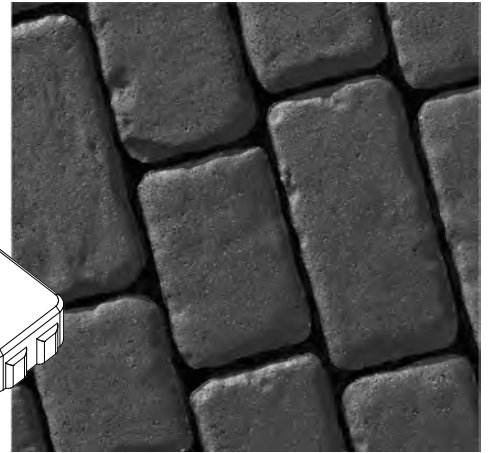
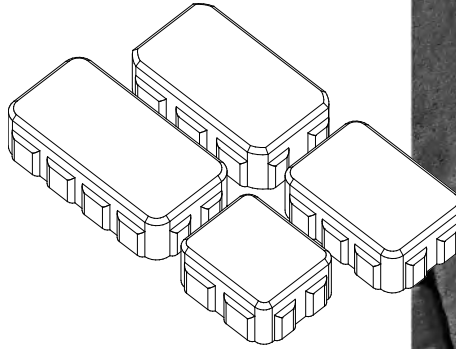

Size	Face Area	Units/Layer	Layer	Layer	Layers	Units/Pallet	Pallet	Pallet Weight
7.125 x 5.875 x 3.125" H	0.29 sq. ft.	8						
8.625 x 5.875 x 3.125" H	0.36 sq. ft.	8	12.33 sq. ft.	12.4 sq. ft.	6	192	74 sq. ft.	2,575 lbs.
10.375 x 5.875 x 3.125" H	0.42 sq. ft.	8						
11.875 x 5.875 x 3.125" H	0.48 sq. ft.	8						

**Notes:** Available by pallet or layer. Install in a running bond pattern alternating sizes as you go. Santa Fe available while supplies last, call for availability.

# flagstone 6cm paver

Interlock Concrete Products

## Features

- One shape, six unique slate faces
- Deep/wide false joint
- Suitable for pedestrian applications

## Colors

- Antique Brown
- Santa Fe
- Sierra Gray

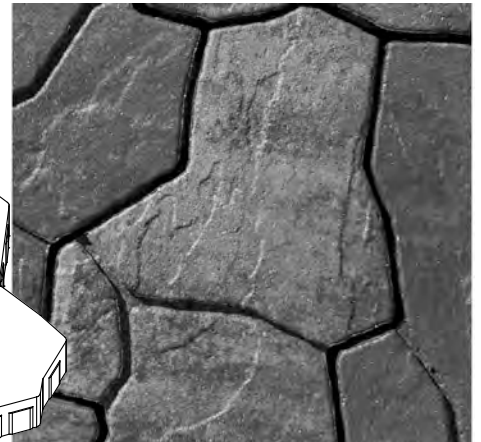
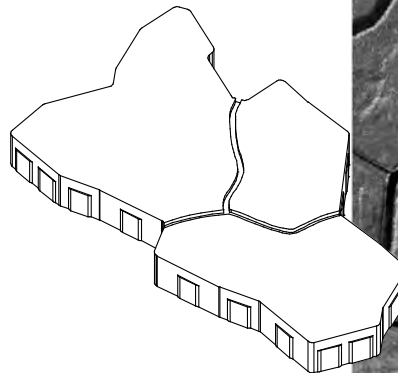

Size	Face Area	Weight	Units/Layer	Layer	Layers	Units/Pallet	Pallet	Pallet Weight
Six Faces	1.58 sq. ft.	45.8 lbs.	6	9.5	10	60	95 sq. ft.	2,806 lbs.

**Notes:** Available by pallet or layer. Lay in a running bond pattern. Use a buffer pad between the plate compactor and surface to prevent scuffing.

**KolorLast™**  
Hardscape Protectant

# colonial 6cm paver

Interlock Concrete Products

## Features

- Circle kits available
- Dimpled top, radius edge
- Auto spacers, 1/16" joint

## Colors

- Antique Copper
- Beechwood
- Carmel
- Desert
- Moonlight Gray

## Rectangle and 3/4 square Colors

- Brown
- Buff
- Charcoal
- Desert Buff
- Onyx\*
- Santa Fe

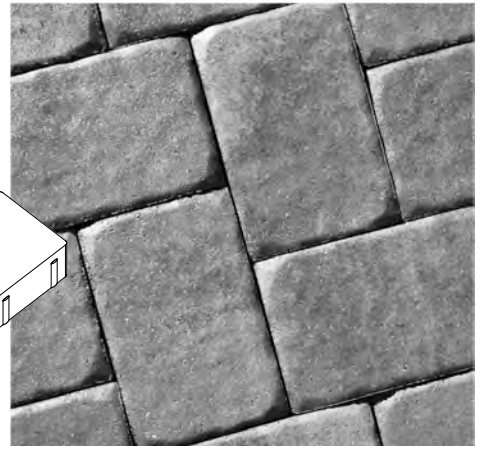
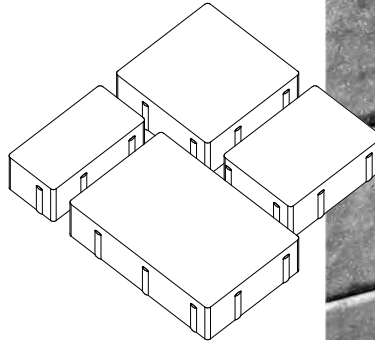

\*Available with or without KolorLast treatment.

Name	Size	Face Area	Weight	Units/Bands	Band	Bands	Units/Pallet	Pallet	Pallet Weight
Half Square	6.30 x 3.15 x 2.375" H	0.14 sq. ft.	3 lbs.	50	6.86 sq. ft.	7	350	48 sq. ft.	1,300 lbs.
3/4 Square	6.30 x 4.65 x 2.375" H	0.20 sq. ft.	6 lbs.	56	11.4 sq. ft.	7	392	80 sq. ft.	2,180 lbs.
Square	6.30 x 6.30 x 2.375" H	0.28 sq. ft.	7 lbs.	50	14 sq. ft.	7	350	98 sq. ft.	2,690 lbs.
Rectangle	6.30 x 9.45 x 2.375" H	0.41 sq. ft.	12 lbs.	45	18.4 sq. ft.	5	225	92 sq. ft.	2,650 lbs.

**Notes:** Available by pallet or band. Special color runs available with set-up fee, minimum quantities apply. Customer must take 100% of product run. Antique Brown is available while supplies last, call for availability.

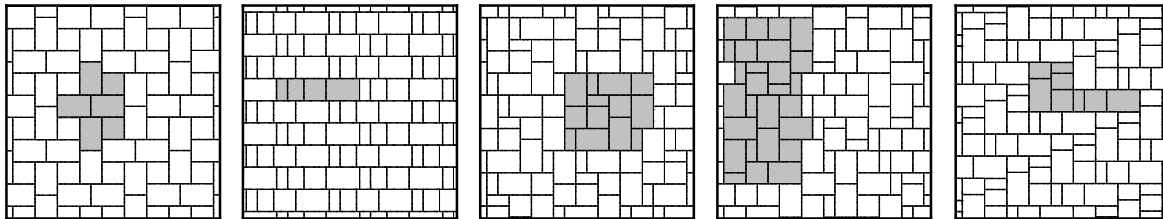

Name	Pattern 1	Pattern 2	Pattern 3	Pattern 4	Pattern 5
Half Square		13.37%	14.81%	14.55%	13.37%
Ratio		1	4	8	2
3/4 Square		19.75%			19.75%
Ratio		1			2
Square	25%	26.75%	29.63%	36.36%	26.75%
Ratio	2	1	4	10	2
Rectangle	75%	40.13%	55.56%	49.09%	40.13%
Ratio	4	1	5	9	2

# colonial circle 6cm paver

Interlock Concrete Products

## Features

- Auto spacers, 1/16" joint
- Expand to any size

## Colors

- Antique Copper
- Beechwood
- Carmel
- Desert
- Moonlight Gray

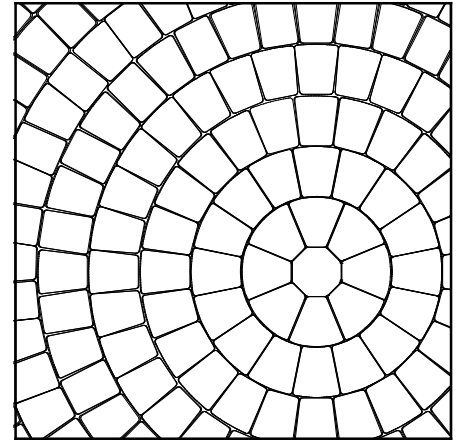

Name	Size	Face Area	Weight	Units/Layer	Layers	Units/Pallet	Pallet	Pallet Weight
Large circle (wedges)	6.3 x 5.2 x 2.375" H	0.23 sq. ft.	6 lbs.	40	7	280	56 sq. ft.	1,550 lbs.

Name	Size	Face Area	Weight	Units/Bands	Bands/Pallet	Units/Pallet	Pallet	Pallet Weight
Starter Circle Kit	Various			30	6		36 sq. ft.	1,060 lbs.
¾ Square	4.65 x 6.30	0.20 sq. ft.	6.66 lbs.	56	7	392	80 sq. ft.	2,180 lbs.

**Notes:** Available by pallet or band/layer. Starter circle kit creates a 2 course circle. 6 starter circle kits per pallet.  
**To make the 13.25 ft. dia. circle, you need the circle starter kit, plus one pallet of wedges, and one pallet of ¾ squares.**  
 Antique Brown is available while supplies last, call for availability.

Course	Diameter	Area	Starter Circle Kit	Large Circle Pallet			¾ Square Pallet		
				Pallet	Units	Layers	Units	Pallets	Bands
Center Piece	0.53 ft.	0.22 sq. ft.	1						
1	1.58 ft.	1.97 sq. ft.	1						
2	2.64 ft.	5.48 sq. ft.	1						
3	3.70 ft.	10.75 sq. ft.	1		26	1			
4	4.76 ft.	17.78 sq. ft.	1		34	2			
5	5.82 ft.	26.57 sq. ft.	1		21	2	21		1
6	6.88 ft.	37.12 sq. ft.	1		26	3	24		1
7	7.93 ft.	49.43 sq. ft.	1		30	4	30		2
8	8.99 ft.	63.50 sq. ft.	1		34	5	33		2
9	10.05 ft.	79.33 sq. ft.	1		38	6	38		3
10	11.11 ft.	96.91 sq. ft.	1	1	42		42		4
11	12.17 ft.	116.26 sq. ft.	1	1			90		5
12	13.23 ft.	137.37 sq. ft.	1	1			99	1	
13	14.28 ft.	160.23 sq. ft.	1	1			107	1	2
14	15.34 ft.	184.86 sq. ft.	1	1			116	1	4
15	16.40 ft.	211.24 sq. ft.	1	1			124	1	6
16	17.46 ft.	239.38 sq. ft.	1	1			133	2	2
17	18.52 ft.	269.29 sq. ft.	1	1			142	2	4
18	19.58 ft.	300.95 sq. ft.	1	1			150	3	
19	20.63 ft.	334.37 sq. ft.	1	1			159	3	3
20	21.69 ft.	369.55 sq. ft.	1	1			167	3	6
21	22.75 ft.	406.49 sq. ft.	1	1			176	4	2
22	23.81 ft.	445.19 sq. ft.	1	1			184	4	5
23	24.87 ft.	485.65 sq. ft.	1	1			193	5	2
24	25.93 ft.	527.87 sq. ft.	1	1			202	5	5
25	26.98 ft.	571.85 sq. ft.	1	1			210	6	2
26	28.04 ft.	617.59 sq. ft.	1	1			219	6	6
27	29.10 ft.	665.08 sq. ft.	1	1			227	7	3
28	30.16 ft.	714.34 sq. ft.	1	1			236	8	

# colonial 8cm paver

Interlock Concrete Products

## Features

- Auto spacers, 1/16" joint
- Dimpled top, radius edge
- Ideal companion to Navarro paver
- Suitable for vehicular applications

## Colors

- Antique Brown
- Antique Copper
- Beechwood
- Brown
- Charcoal

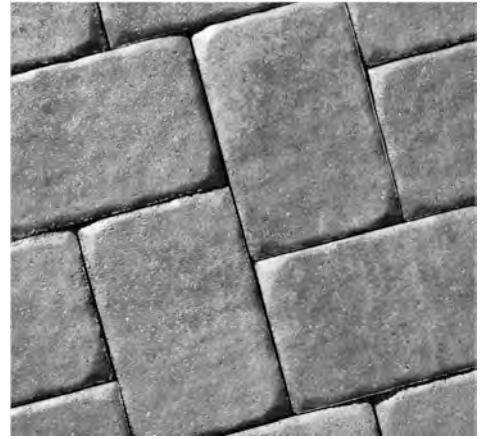

Name	Size	Face Area	Weight	Units/Bands	Bands	Band	Units/Pallet	Pallet	Pallet Weight
Square	6.30 x 6.30 x 3.125" H	0.28 sq. ft.	10 lbs.	35	7	9.71 sq. ft.	245	68 sq. ft.	2,560 lbs.
Rectangle	6.30 x 9.45 x 3.125" H	0.41 sq. ft.	16 lbs.	35	5	14.4 sq. ft.	175	72 sq. ft.	2,750 lbs.

**Notes:** Available by pallet or band. Special color runs available with set-up fee, minimum quantities apply. Customer must take 100% of product run.

# holland 6cm and 8cm pavers

Interlock Concrete Products

## Features

- One shape, six unique slate faces
- Deep/wide false joint
- Suitable for vehicular applications

## 6cm Colors

- Antique Copper
- Beechwood
- Carmel
- Desert
- Moonlight Gray
- Rosewood

## 6cm Accent Colors

- Brown
- Buff
- Charcoal
- Onyx\*

## 8cm Colors

- Buff
- Charcoal

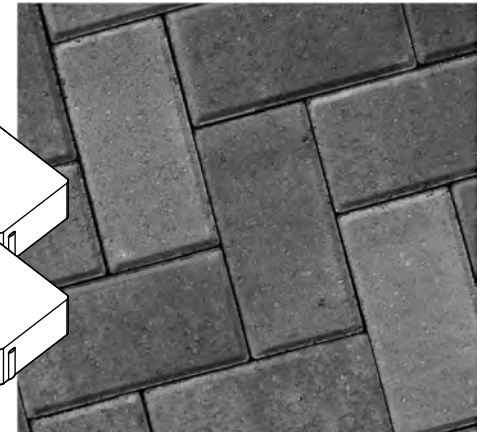
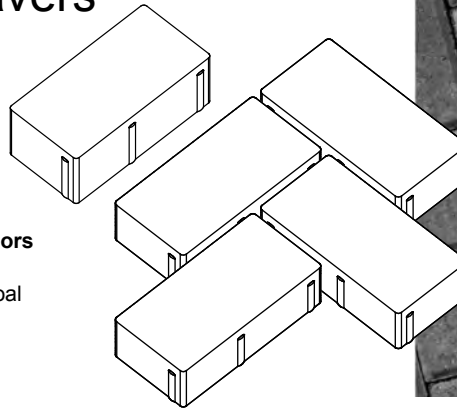

\*Available with or without KolorLast treatment.

Name	Size	Face Area	Weight	Units/Bands	Bands	Band	Units/Pallet	Pallet	Pallet Weight
6cm	8.5 x 4.25x 2.375" H	0.24 sq. ft.	7 lbs.	80	5	19.6 sq. ft.	400	98 sq. ft.	2,785 lbs.
8cm	8.5 x 4.25 x 3.125" H	0.24 sq. ft.	9 lbs.	56	5	13.8 sq. ft.	280	69 sq. ft.	2,560 lbs.

**Notes:** Available by pallet or band.

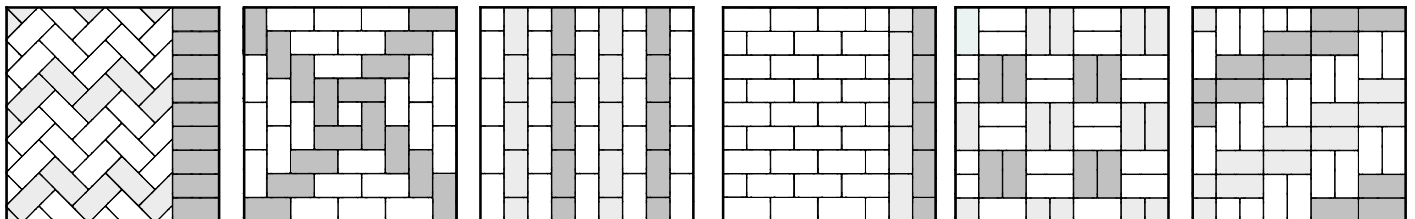

# victorian 6cm paver

Interlock Concrete Products

## Features

- Circle kits available
- Smooth top, radius edge
- No auto spacers, zero joint

## Colors

- Antique Copper
- Beechwood
- Rosewood

## Rectangle Colors

- Brown
- Buff
- Charcoal

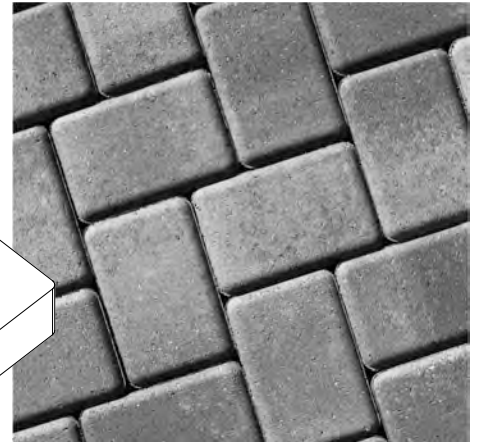
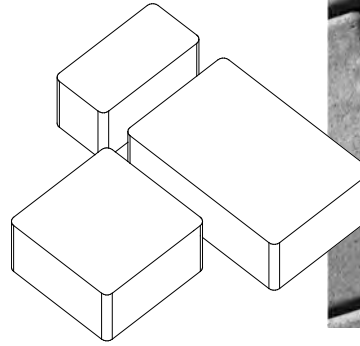

Name	Size	Face Area	Weight	Units/Bands	Bands	Band	Units/Pallet	Pallet	Pallet Weight
Half Square	4.62 x 2.31 x 2.375" H	0.07 sq. ft.	2 lbs.	55	9	4.44 sq. ft.	495	40 sq. ft.	1,000 lbs.
Square	4.62 x 4.62 x 2.375" H	0.15 sq. ft.	4 lbs.	56	9	8.44 sq. ft.	504	76 sq. ft.	2,425 lbs.
Rectangle	7 x 4.62 x 2.375" H	0.23 sq. ft.	7 lbs.	70	6	16 sq. ft.	420	96 sq. ft.	2,650 lbs.

**Notes:** Available by pallet or band. Special color runs available with set-up fee, minimum quantities apply. Customer must take 100% of product run. Carmel, Desert, and Moonlight Gray available while supplies last, call for availability.

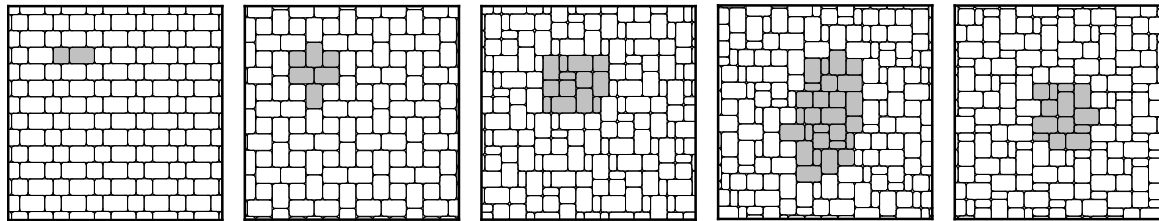

	Pattern 1	Pattern 2	Pattern 3	Pattern 4	Pattern 5
Half Square			14.53%	13.56%	14.53%
Ratio			4	8	4
Square	40%	25%	29.53%	36.32%	29.53%
Ratio	1	2	4	10	4
Rectangle	60%	75%	55.94%	50.12%	55.94%
Ratio	1	4	5	9	5



# victorian circle 6cm paver

Interlock Concrete Products

## Features

- All on one pallet
- Pallet makes 10 ft. circle
- Smooth top, radius edge
- No auto spacers, zero joint

## Colors

- Antique Copper
- Beechwood
- Rosewood

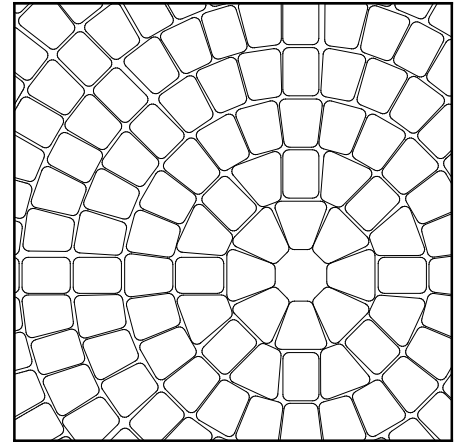

Name	Size	Face Area	Weight	Units/Pallet	Pallet	Pallet Weight
Center Piece	4.62 diameter x 2.375" H	0.11 sq. ft.	4.50 lbs.	8		
Small Triangle	4.62 x 5.81 x 2.375" H	0.12 sq. ft.	3.85 lbs.	32	79 sq. ft.	2,070 lbs.
Large Triangle	4.38 x 4.62 x 2.375" H	0.14 sq. ft.	4.83 lbs.	192		
Square	4.62 x 4.62 x 2.375" H	0.15 sq. ft.	4.82 lbs.	328		

**Notes:** Available by pallet. Circle pallet creates a 10 ft. diameter. Carmel, Desert, and Moonlight Gray available while supplies last, call for availability.

Course No.	Diameter	Area	Starter Kit				Sq. Units	Sq. Pallets	Sq. Bands
			Center	Small Triangle	Large Triangle	Square			
Center	0.39 ft.	0.12 sq. ft.	1	0	0	0			
1	1.18 ft.	1.10 sq. ft.	0	8	0	0			
2	1.98 ft.	3.07 sq. ft.	0	4	12	0			
3	2.77 ft.	6.04 sq. ft.	0	0	24	0			
4	3.57 ft.	10.00 sq. ft.	0	0	26	4			
5	4.36 ft.	14.96 sq. ft.	0	0	16	18			
6	5.16 ft.	20.91 sq. ft.	0	0	22	20			
7	5.96 ft.	27.86 sq. ft.	0	0	24	25			
8	6.75 ft.	35.80 sq. ft.	0	0	28	28			
9	7.55 ft.	44.74 sq. ft.	0	0	31	32			
10	8.34 ft.	54.67 sq. ft.	0	0	4	58			
11	9.14 ft.	65.60 sq. ft.	0	0	0	68			
12	9.94 ft.	77.52 sq. ft.	0	0	0	74			
13	10.73 ft.	90.44 sq. ft.			1	80		2	
14	11.53 ft.	104.35 sq. ft.			1	86		3	
15	12.32 ft.	119.26 sq. ft.			1	92		5	
16	13.12 ft.	135.16 sq. ft.			1	98		7	
17	13.91 ft.	152.06 sq. ft.			1	104		9	
18	14.71 ft.	169.95 sq. ft.			1	110	1	2	
19	15.51 ft.	188.83 sq. ft.			1	116	1	4	
20	16.30 ft.	208.72 sq. ft.			1	122	1	6	
21	17.10 ft.	229.59 sq. ft.			1	128	1	8	
22	17.89 ft.	251.46 sq. ft.			1	134	2	2	
23	18.69 ft.	274.33 sq. ft.			1	140	2	4	
24	19.49 ft.	298.19 sq. ft.			1	145	2	7	
25	20.28 ft.	323.04 sq. ft.			1	151	3	0	
26	21.08 ft.	348.90 sq. ft.			1	157	3	3	
27	21.87 ft.	375.74 sq. ft.			1	163	3	6	
28	22.67 ft.	403.58 sq. ft.			1	169	4	0	
29	23.46 ft.	432.42 sq. ft.			1	175	4	3	
30	24.26 ft.	462.25 sq. ft.			1	181	4	6	

# heartland 6cm paver

Interlock Concrete Products

## Features

- One shape with nine unique faces
- 9 unique faces
- Very fast, running bond installation

## Colors

- Antique Brown
- Beechwood
- Santa Fe
- Sierra Gray



Size	Face Area	Weight	Units/Layer	Layer	Layers	Units/Pallet	Pallet	Pallet Weight
15.43 x 12.60 x 2.375" H	1.09 sq. ft.	29 lbs.	9	9.8 sq. ft.	10	90	98 sq. ft.	2,880 lbs.

**Notes:** Discontinued, available while supplies last. Call for availability.

# fieldstone 6cm paver

Interlock Concrete Products

## Features

- One shape, six unique slate faces
- Deep/wide false joint
- Suitable for pedestrian applications

## Colors

- Antique Brown
- Santa Fe
- Sierra Gray

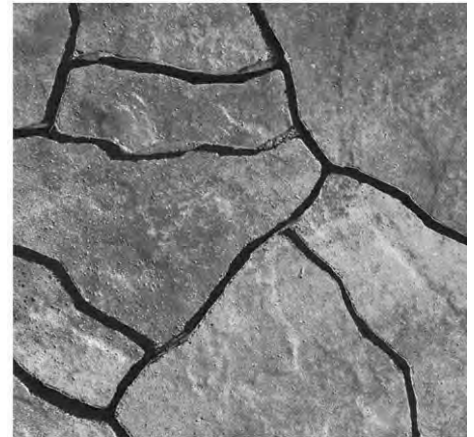

Size	Weight	Units/Layer	Layer	Layers	Units/Pallet	Pallet	Pallet Weight
1.21 sq. ft. x 2.375" H	34 lbs.	8	9.7 sq. ft.	10	80	97 sq. ft.	2,725 lbs.

**Notes:** Available by pallet or layer. Discontinued, available while supplies last. Call for availability. Lay in a running bond pattern. Use a buffer pad between the plate compactor and surface to prevent scuffing.

# holland eco 8cm permeable paver

Interlock Concrete Products

## Features

- The classic look of brick pavers
- Oversized, gives application grander scale
- Machine installation friendly

## Colors

- Beechwood
- Carmel

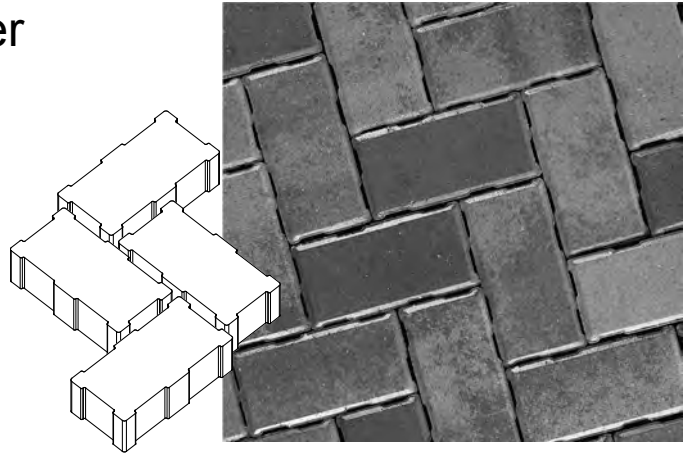

Size	Face Area	Weight	Units/Layer	Layer	Layers	Units/Pallet	Pallet	Pallet Weight
4.875 x 9.75 x 3.125" H	0.34 sq. ft.	13 lbs.	28	10.4 sq. ft.	8	224	83 sq. ft.	3,050 lbs.
4.875 x 4.875 x 3.125" H	0.17sq. ft.	6.54 lbs.	7		8	56		

**Notes:** Available by pallet. Special order may be required.

# turfstone 8cm permeable paver

Interlock Concrete Products

## Colors

- Gray

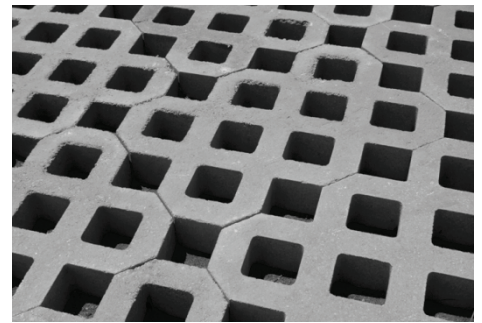

Size	Face Area	Weight	Units/Bands	Band	Bands	Units/Pallet	Pallet	Pallet Weight
23.63 x 15.75 x 3.125" H	2.58 sq. ft.	64.5 lbs.	16	41 sq. ft.	2	32	82 sq. ft.	1,940 lbs.

**Notes:** Available by pallet. Voids = 0.25 cu. ft. per unit.

# paver material requirements

Use the following methods to estimate the amount of materials you will need for your project.

## 1. Excavation Depth Guide

	Pedestrian Traffic	Light Vehicular Traffic
Pavers	2 3/8"	2 3/8"
Sand	1"	1"
Gravel Base (compacted)	4" – 6"	8" – 12"
Total Excavation Depth	7" – 9"	11" – 15"

Gravel Base: Use minimum depths in a well-drained area or undisturbed soil. Use maximum depths in poorly drained area or disturbed soil. 1/2" less is required to compensate compacting of pavers. If soil is saturated more than 50% of the time, filter fabric and extra base should be used.

## 2. Base Material Calculator

### Granular Base

Square Footage of Pavers x (depth of base ÷ 12) ÷ 27 = Cubic Yards of Base Needed

### Bedding Sand – 1" depth

Square Footage of Pavers x 0.0031 = Cubic Yards of Sand Needed

## 3. Edge Restraint Calculator

Length of restrained pavers (ft.) ÷ 8 = number of pieces of SnapEdge  
Use one spike for every foot of retained pavers.

## 4. Calculate Borders and Accents

$$\frac{\text{Length of Border (ft.)}}{\text{Length of Product (ft.)}} \div \frac{\text{Length of Product (ft.)}}{\text{Length of Product (ft.)}} = \text{Number of units}$$

Example: Cobble Border

$$\frac{30}{\text{Length of Border (ft.)}} \div \frac{0.83}{\text{Length of Product (ft.)}} = \frac{36}{\text{Number of units}}$$

### **CAUTION – Using A Plate Compactor!**

Avoid scuffs on paver surfaces. Pavers with embossed surfaces (high and low points) are more susceptible to scuff marks from plate compactors. Always use a urethane mat between the plate and the paver surface when compacting. Rochester Concrete Products is not responsible for compaction scuffs or burns on pavers.

# vintage 6 wall

Rockwood Retaining Walls

## Features

- Three-piece system (set) spilt-faced, tumbled vertical wall system
- Builds an 8 ft. radius seat wall — no cutting
- Builds freestanding or retaining walls

## Colors

- Beechwood
- Bluestone
- Santa Fe
- Desert Buff

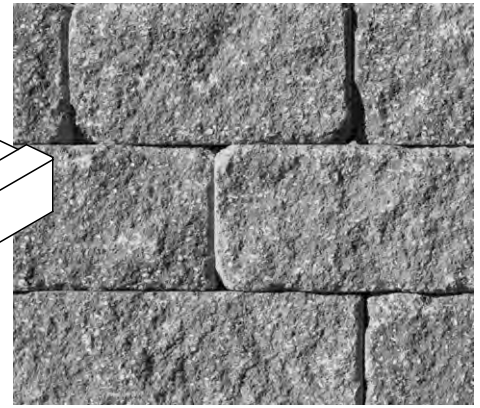
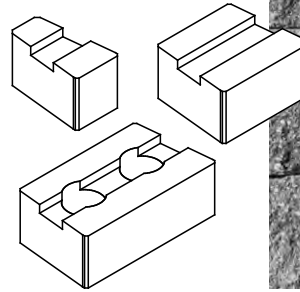

Name	Size W x D x H	Face Area	Weight	Sets/Layer	Layers	Sets/Pallet	Pallet	Pallet Weight
Small	6 x 10 x 6" H	0.25 sq. ft.						
Medium	12 x 10 x 6" H	0.50 sq. ft.	137.5 lbs.	4	5	20 sets	30 sq. ft.	2,800 lbs.
Large	18 x 10 x 6" H	0.75 sq. ft.						
Corner/pillar block	12 x 9 x 6" H	0.50 sq. ft.	48 lbs.			30	15 sq. ft.	1,490 lbs.
End block	6 x 10 x 6" H	0.42 sq. ft.	81.50 lbs.			8 sets	10 sq. ft.	702 lbs.
End block	2 x 10 x 6" H	0.83 sq. ft.						

**Notes:** Blocks available by pallet, end pieces available by the set or pallet, corners available by pallet.

# vintage 4 and 8 walls

Rockwood Retaining Walls

## Features

- Six-piece, spilt-faced, tumbled vertical wall system
- Builds an 8 ft. radius seat wall — no cutting
- Builds freestanding or retaining walls

## Colors

- Bluestone
- Desert
- Santa Fe

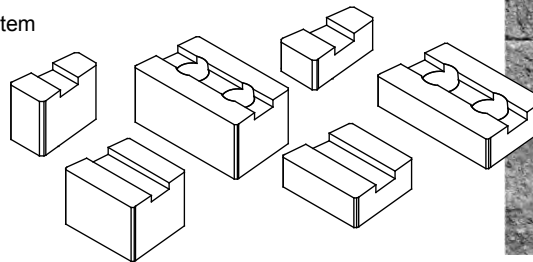

Name	Size W x D x H	Face Area	Weight	Units/Layer	Layers	Units/Pallet	Pallet	Pallet Weight
8" Small	6 x 10 x 8" H	1 sq. ft.	101 lbs.				27 sq. ft.	2,777 lbs.
8" Medium	12 x 10 x 8" H		per set	9 sets	3	27 sets		
8" Large	18 x 10 x 8" H	1 sq. ft.	91 lbs.	9	3	27	27 sq. ft.	2,507 lbs.
8" Corner	18 x 9 x 8" H	1 sq. ft.	100 lbs.	10	2	20	20 sq. ft.	2,050 lbs.
8" End Piece	18 x 10.5 x 8" H	0.88 sq. ft.	118 lbs.	8	1	8	7 sq. ft.	994 lbs.
4" Small	6 x 10 x 4" H	0.50 sq. ft.	50 lbs.				27 sq. ft.	2,750 lbs.
4" Medium	12 x 10 x 4" H		per set	per set	9 sets	6		
4" Large	18 x 10 x 4" H	0.50 sq. ft.	41 lbs.	9	6	54	27 sq. ft.	2,264 lbs.
4" Corner	18 x 9 x 4" H	0.50 sq. ft.	50 lbs.	10	2	20	10 sq. ft.	1,050 lbs.
4" End Piece	18 x 10.5 x 4" H	0.44 sq. ft.	59 lbs.	8	1	8	3.52 sq. ft.	522 lbs.

**Notes:** Blocks available by layer or pallet, end pieces available by the set or pallet, corners available by piece or pallet.

# vintage 4 and 8 retaining wall patterns

Rockwood Retaining Walls

## Construction Preparation for Retaining Walls

The first thing to consider is the wall height and combination of wall patterns you want to use in your retaining wall design. The buried base should consist of 8" x 18" block with a combination of 16", 24", and/or 32" wall patterns, which can be installed after embedment. To achieve the desired height of your wall, a combination of any suggested wall pattern can be used. (i.e., 24" wall pattern can be topped with a 16" wall pattern or vice versa.)

## Calculating Block Requirements for Retaining Walls

To calculate the number of individual blocks required for your retaining wall, select a 16", 24", or 32" pattern and refer to the example calculations below. Since each pattern has a fixed number of blocks, calculating the quantity of blocks required is done by multiplying your total wall square footage by the individual blocks per pattern.

Pattern examples and calculations:

 = Front (Long) sides of Vintage block

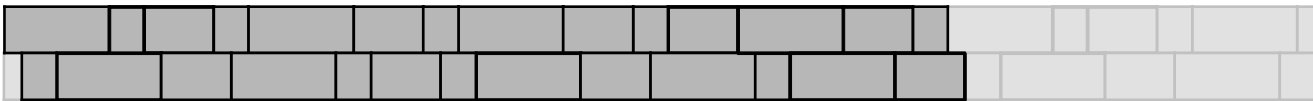

### **Block Required for 16" Tall Retaining Wall (18 sq ft)**

- 9 - 8" x 18" Blocks = 9 sq ft
- 9 - 8" x 12" Blocks = 6 sq ft
- 9 - 8" x 6" Blocks = 3 sq ft

Example: 150 sq ft wall (150 ÷ 18 sq ft = 8.33 patterns)

- 8" x 18" = 9 x 8.33 = 75 blocks
- 8" x 12" = 9 x 8.33 = 75 blocks
- 8" x 6" = 9 x 8.33 = 75 blocks

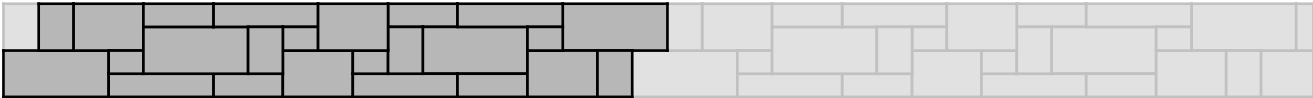

### **Block Required for 16" Tall Retaining Wall (12 sq ft)**

- 4 - 8" x 18" Blocks = 4 sq ft
- 4 - 8" x 12" Blocks = 2.67 sq ft
- 4 - 8" x 6" Blocks = 1.33 sq ft
- 4 - 4" x 18" Blocks = 2 sq ft
- 4 - 4" x 12" Blocks = 1.33 sq ft
- 4 - 4" x 6" Blocks = 0.67 sq ft

Example: 150 sq ft wall (150 ÷ 12 sq ft = 12.5 patterns)

- 8" x 18" = 4 x 12.5 = 50 blocks
- 8" x 12" = 4 x 12.5 = 50 blocks
- 8" x 6" = 4 x 12.5 = 50 blocks
- 4" x 18" = 4 x 12.5 = 50 blocks
- 4" x 12" = 4 x 12.5 = 50 blocks
- 4" x 6" = 4 x 12.5 = 50 blocks

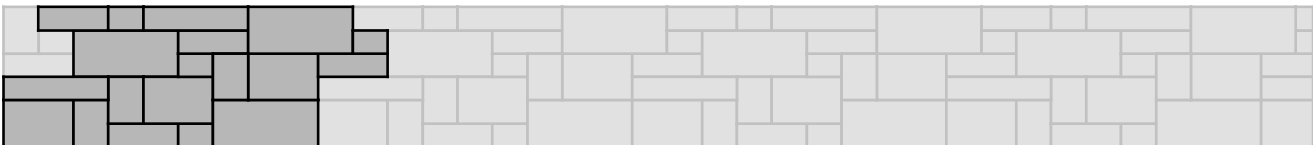

### **Block Required for 24" Tall Retaining Wall (10 sq ft)**

- 4 - 8" x 18" Blocks = 4 sq ft
- 3 - 8" x 12" Blocks = 2 sq ft
- 3 - 8" x 6" Blocks = 1 sq ft
- 3 - 4" x 18" Blocks = 1.5 sq ft
- 3 - 4" x 12" Blocks = 1 sq ft
- 3 - 4" x 6" Blocks = 0.50 sq ft

Example: 150 sq ft wall (150 ÷ 10 sq ft = 15 patterns)

- 8" x 18" = 4 x 15 = 60 blocks
- 8" x 12" = 3 x 15 = 45 blocks
- 8" x 6" = 3 x 15 = 45 blocks
- 4" x 18" = 3 x 15 = 45 blocks
- 4" x 12" = 3 x 15 = 45 blocks
- 4" x 6" = 3 x 15 = 45 blocks

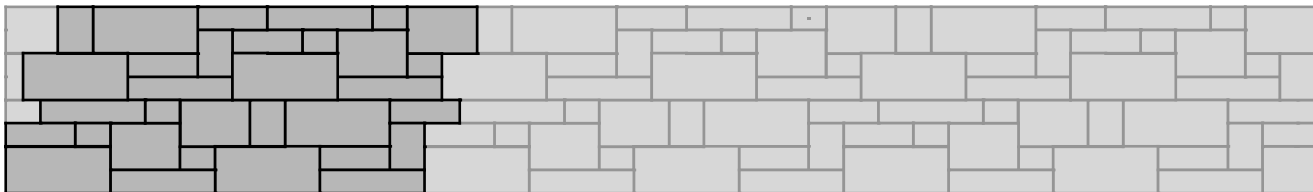

### **Block Required for 32" Tall Retaining Wall (16 sq ft)**

- 6 - 8" x 18" Blocks = 6 sq ft
- 4 - 8" x 12" Blocks = 2.67 sq ft
- 4 - 8" x 6" Blocks = 1.33 sq ft
- 6 - 4" x 18" Blocks = 3 sq ft
- 6 - 4" x 12" Blocks = 2 sq ft
- 6 - 4" x 6" Blocks = 1 sq ft

Example: 150 sq ft wall (150 ÷ 16 sq ft = 9.375 patterns)

- 8" x 18" = 6 x 9.375 = 57 blocks
- 8" x 12" = 4 x 9.375 = 38 blocks
- 8" x 6" = 4 x 9.375 = 38 blocks
- 4" x 18" = 6 x 9.375 = 57 blocks
- 4" x 12" = 6 x 9.375 = 57 blocks
- 4" x 6" = 6 x 9.375 = 57 blocks

# vintage 4 and 8 freestanding wall patterns

Rockwood Retaining Walls

## Construction Preparation for Freestanding Walls

The first thing to consider is the wall height and combination of wall patterns you want to use in your freestanding wall design. The buried base should consist of 8" x 18" block with a combination of 16", 24", and/or 32" wall patterns, which can be installed after embedment. To achieve the desired height of your wall, a combination of any suggested wall pattern can be used. (i.e., 24" wall pattern can be topped with a 16" wall pattern or vice versa.)

## Calculating Block Requirements for Freestanding Walls

To calculate the number of individual blocks required for your freestanding wall, select a 16", 24", or 32" pattern and refer to the example calculations below. Since each pattern has a fixed number of blocks, calculating the quantity of blocks required is done by multiplying your total wall square footage by the individual blocks per pattern.

*Note: Freestanding walls will likely require End Blocks. Check with your supplier for availability.*

Pattern examples and calculations:



= Back (short) sides of Vintage block



= Front (long) sides of Vintage block



### Block Required for 8" Tall Freestanding Wall (15.67 sq ft)

- 8 - 8" x 18" Blocks = 7.56 sq ft
- 10 - 8" x 12" Blocks = 6.11 sq ft
- 6 - 8" x 6" Blocks = 2 sq ft

Example: 150 sq ft wall (150 ÷ 15.67 sq ft = 9.57 patterns)

- 8" x 18" = 8 x 9.57 = 77 blocks
- 8" x 12" = 10 x 9.57 = 96 blocks
- 8" x 6" = 6 x 9.57 = 58 blocks

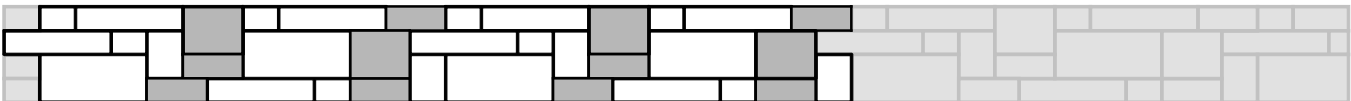

### Block Required for 16" Tall Freestanding Wall (7.56 sq ft)

- 2 - 8" x 18" Blocks = 2 sq ft
- 2 - 8" x 12" Blocks = 1.11 sq ft
- 2 - 8" x 6" Blocks = .67 sq ft
- 4 - 4" x 18" Blocks = 2 sq ft
- 4 - 4" x 12" Blocks = 1.11 sq ft
- 4 - 4" x 6" Blocks = .67 sq ft

Example: 150 sq ft wall (150 ÷ 7.56 sq ft = 20 patterns)

- 8" x 18" = 2 x 20 = 40 blocks
- 8" x 12" = 2 x 20 = 40 blocks
- 8" x 6" = 2 x 20 = 40 blocks
- 4" x 18" = 4 x 20 = 80 blocks
- 4" x 12" = 4 x 20 = 80 blocks
- 4" x 6" = 4 x 20 = 80 blocks

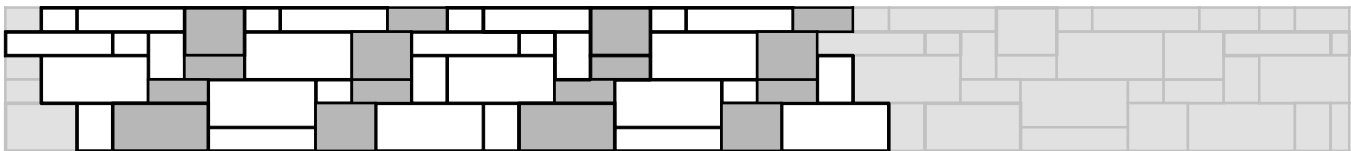

### Block Required for 24" Tall Freestanding Wall (11.34 sq ft)

- 5 - 8" x 18" Blocks = 4.89 sq ft
- 3 - 8" x 12" Blocks = 1.67 sq ft
- 3 - 8" x 6" Blocks = 1 sq ft
- 4 - 4" x 18" Blocks = 2 sq ft
- 4 - 4" x 12" Blocks = 1.11 sq ft
- 4 - 4" x 6" Blocks = 0.67 sq ft

Example: 150 sq ft wall (150 ÷ 11.34 sq ft = 13.22 patterns)

- 8" x 18" = 5 x 13.22 = 66 blocks
- 8" x 12" = 3 x 13.22 = 40 blocks
- 8" x 6" = 3 x 13.22 = 40 blocks
- 4" x 18" = 4 x 13.22 = 53 blocks
- 4" x 12" = 4 x 13.22 = 53 blocks
- 4" x 6" = 4 x 13.22 = 53 blocks

# vintage 4 and 8 freestanding radius wall patterns

Rockwood Retaining Walls

## Construction Preparation for Freestanding Radius Walls

These freestanding Seat Wall patterns build a 8' outside radius.

Pattern examples and calculations:  = Front (long) sides of Vintage block

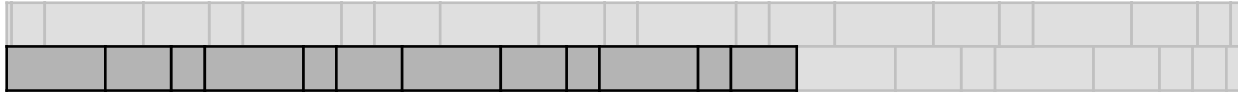

### Block Required for 8" Tall Freestanding Radius Wall (8 sq ft)

- 4 - 8" x 18" Blocks = 4 sq ft
- 4 - 8" x 12" Blocks = 2.67 sq ft
- 4 - 8" x 6" Blocks = 1.33 sq ft

Example: 150 sq ft wall (150 ÷ 8 sq ft = 18.75 patterns)

- 8" x 18" = 4 x 18.75 = 75 blocks
- 8" x 12" = 4 x 18.75 = 75 blocks
- 8" x 6" = 4 x 18.75 = 75 blocks

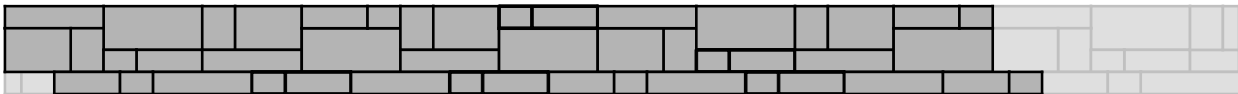

### Block Required for 16" Tall Freestanding Radius Wall (20 sq ft)

- 5 - 8" x 18" Blocks = 6 sq ft
- 5 - 8" x 12" Blocks = 2.67 sq ft
- 5 - 8" x 6" Blocks = 1.33 sq ft
- 9 - 4" x 18" Blocks = 3 sq ft
- 11 - 4" x 12" Blocks = 2 sq ft
- 11 - 4" x 6" Blocks = 1 sq ft

Example: 150 sq ft wall (150 ÷ 20 sq ft = 7.5 patterns)

- 8" x 18" = 5 x 7.5 = 38 blocks
- 8" x 12" = 5 x 7.5 = 38 blocks
- 8" x 6" = 5 x 7.5 = 38 blocks
- 4" x 18" = 9 x 7.5 = 68 blocks
- 4" x 12" = 11 x 7.5 = 83 blocks
- 4" x 6" = 11 x 7.5 = 83 blocks

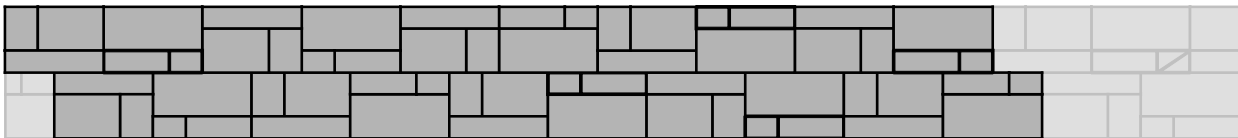

### Block Required for 24" Tall Freestanding Radius Wall (30 sq ft)

- 10 - 8" x 18" Blocks = 10 sq ft
- 10 - 8" x 12" Blocks = 6.67 sq ft
- 10 - 8" x 6" Blocks = 3.33 sq ft
- 10 - 4" x 18" Blocks = 5 sq ft
- 10 - 4" x 12" Blocks = 3.33 sq ft
- 10 - 4" x 6" Blocks = 1.67 sq ft

Example: 150 sq ft wall (150 ÷ 30 sq ft = 5 patterns)

- 8" x 18" = 10 x 5 = 50 blocks
- 8" x 12" = 10 x 5 = 50 blocks
- 8" x 6" = 10 x 5 = 50 blocks
- 4" x 18" = 10 x 5 = 50 blocks
- 4" x 12" = 10 x 5 = 50 blocks
- 4" x 6" = 10 x 5 = 50 blocks



# riverland wall

Rockwood Retaining Walls

## Features

- Three-piece, smooth faced, tumbled system
- Builds an 8 ft. radius seat wall — no cutting
- Integrates perfectly with Lakeland system

## Colors

- Beechwood
- Bluestone
- Desert
- Santa Fe
- Onyx

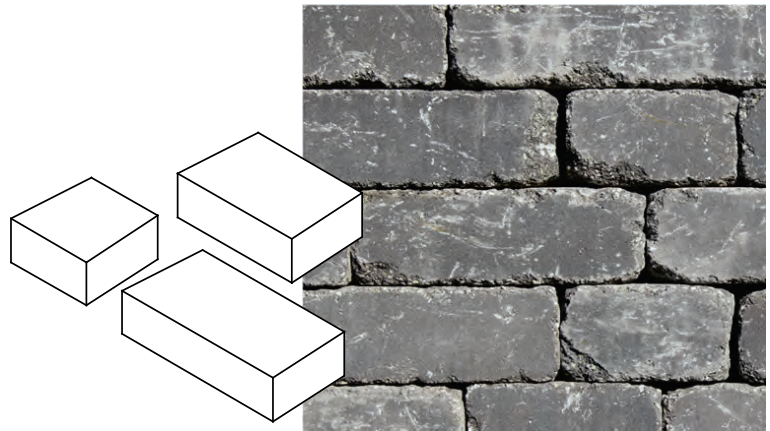

Name	Size W x D x H	Face Area	Weight	Layers	Sets/Layer	Sets/Pallet	Pallet	Pallet Weight
Small	8 x 8 x 4" H							
Medium	12 x 8 x 4" H	1 sq. ft.	90 lbs.	6	5	30	30 sq. ft.	2,750 lbs.
Large	16 x 8 x 4" H							

**Notes:** Available by pallet.

# lakeland wall

Rockwood Retaining Walls

## Features

- Three-piece, smooth-faced, tumbled wall system
- Builds freestanding or retaining walls
- Integrates perfectly with Lakeland system

## Colors

- Beechwood
- Bluestone
- Desert
- Santa Fe
- Onyx

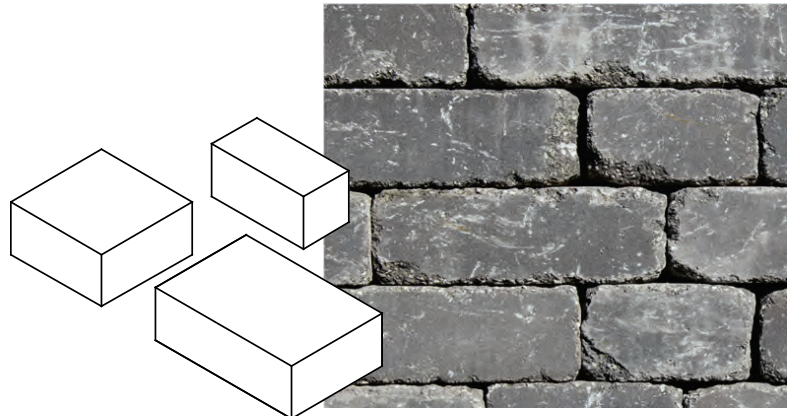

Name	Size W x D x H	Face Area	Weight	Units/Layer	Layers	Units/Pallet	Pallet	Pallet Weight
Small	4 x 8 x 4" H	0.33 sq. ft.	31 lbs.	20	4	80	26 sq. ft.	2,530 lbs.
Medium	8 x 8 x 4" H							
Large	12 x 8 x 4" H	0.33 sq. ft.	31 lbs.	20	4	80	26 sq. ft.	2,530 lbs.

**Notes:** Available by pallet. To estimate number of units, divide total sq. ft. by 0.33. **Large (Non-Tumbled) available in Onyx only.**

# classic 8 chiseled face wall

Rockwood Retaining Walls

## Features

- Most efficient retaining wall system to build
- Lowest unit weight per sq. ft.
- One unit system, split blocks for half and corner units
- Adjustable setback

## Colors

- Bluestone
- Limestone Gray
- Santa Fe

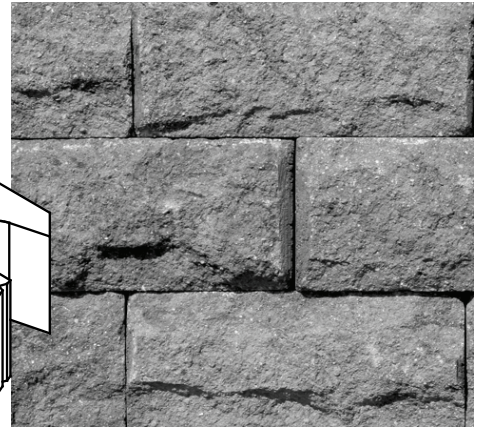
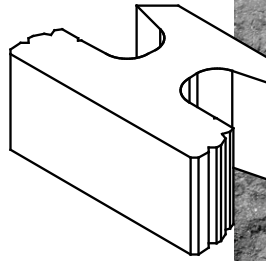

Name	Size W x D x H	Face Area	Weight	Units/Layer	Layers	Units/Pallet	Pallet	Pallet Weight
Block	18 x 12 x 8" H	1 sq. ft.	80 lbs.	12	2	24	24 sq. ft.	1,970 lbs.
Base Block	18 x 12 x 8" H	1 sq. ft.	80 lbs.	12	2	24	24 sq. ft.	1,970 lbs.
Corner Block	13 x 5.5 x 8" H	0.72 sq. ft.	40 lbs.	12	1	12	16.6 sq. ft.	530 lbs.

**Notes:** Available by pallet.

# classic colonial 6 and 8 walls

Rockwood Retaining Walls

## Features

- One unit system creates random look
- Blocks easily split into half and corner units
- Easy to handle and install
- Adjustable setback

## Colonial 6 Colors

- Bluestone
- Santa Fe
- Sandstone Brown

## Colonial 8 Colors

- Sandstone Brown

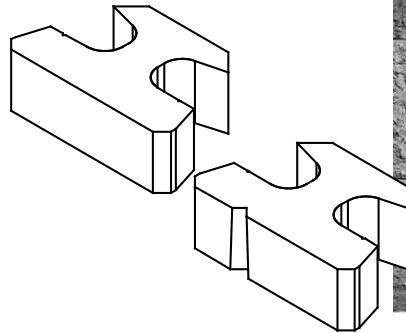

Name	Size W x D x H	Face Area	Weight	Units/Layer	Layers	Units/Pallet	Pallet	Pallet Weight
6" Colonial 18	18 x 12 x 6" H	0.75 sq. ft.	60 lbs.	12	3	36	27 sq. ft.	2,210 lbs.
6" Colonial 6/12	18 x 12 x 6" H	0.75 sq. ft.	60 lbs.	12	3	36	27 sq. ft.	2,210 lbs.
6" Base Block	18 x 12 x 6" H	0.75 sq. ft.	60 lbs.	12	3	36	27 sq. ft.	2,210 lbs.
6" Half Block	9 x 12 x 6" H	0.38 sq. ft.	30 lbs.	12	1	12	4.56 sq. ft.	410 lbs.
6" Corner Block	13 x 5.5 x 6" H	0.54 sq. ft.	32 lbs.	12	1	12	6.48 sq. ft.	434 lbs.
8" Colonial 18	18 x 12 x 8" H	1 sq. ft.	85 lbs.	12	2	24	24 sq. ft.	2,090 lbs.
8" Colonial 6/12	18 x 12 x 8" H	1 sq. ft.	85 lbs.	12	2	24	24 sq. ft.	2,090 lbs.
8" Base Block	18 x 12 x 8" H	1 sq. ft.	85 lbs.	12	2	24	24 sq. ft.	2,090 lbs.
8" Half Block	9 x 12 x 8" H	0.50 sq. ft.	39 lbs.	12	1	12	6 sq. ft.	518 lbs.
8" Corner Block	13 x 5.5 x 8" H	0.72 sq. ft.	40 lbs.	12	1	12	8.64 sq. ft.	530 lbs.

**Notes:** Available by layer or pallet. Colonial 6/12 and 18 palletized separately. To estimate number of units, divide total sq. ft. by 0.75 for Classic Colonial 6. Limited quantities of Colonial 6 in Monterey, call for availability.

# classic 6 and 8 walls

Rockwood Retaining Walls

## Features

- Most efficient retaining wall system to build
- Lowest unit weight per sq. ft.
- One unit system, split blocks for half and corner units
- Adjustable setback

## Classic 6 Colors

- Bluestone
- Charcoal
- Gray
- Sandstone
- Sandstone Brown
- Santa Fe

## Classic 8 Colors

- Brown
- Gray
- Sandstone
- Sandstone Brown

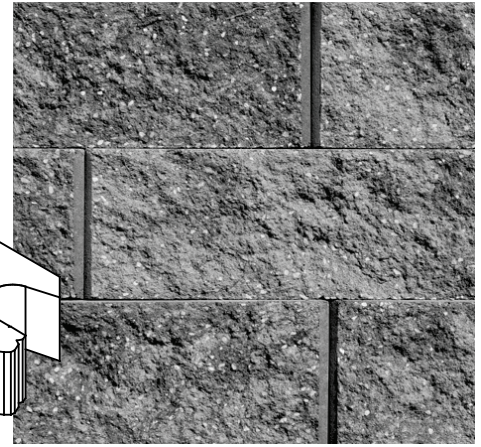
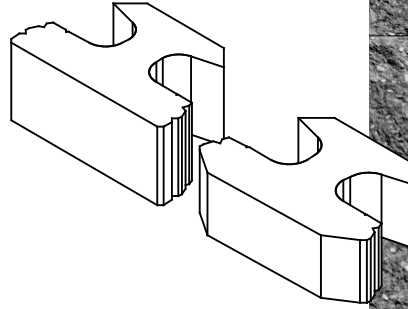

Name	Size W x D x H	Face Area	Weight	Units/Layer	Layers	Units/Pallet	Pallet	Pallet Weight
Classic 6 straight	18 x 12 x 6" H	0.75 sq. ft.	64 lbs.	12	3	36	27 sq. ft.	2,354 lbs.
Straight Base	18 x 12 x 6" H	0.75 sq. ft.	64 lbs.	12	3	36	27 sq. ft.	2,354 lbs.
Classic 6 Beveled	18 x 12 x 6" H	0.75 sq. ft.	60 lbs.	12	3	36	27 sq. ft.	2,210 lbs.
Beveled Base	18 x 12 x 6" H	0.75 sq. ft.	60 lbs.	12	3	36	27 sq. ft.	2,210 lbs.
Half Block	9 x 12 x 6" H	0.38 sq. ft.	30 lbs.	12	1	12	4.56 sq. ft.	410 lbs.
Corner Block	13 x 5.5 x 6" H	0.54 sq. ft.	32 lbs.	12	1	12	6.48 sq. ft.	434 lbs.
Classic 8 Straight	18 x 12 x 8" H	1 sq. ft.	85 lbs.	12	2	24	24 sq. ft.	2,090 lbs.
Straight Base	18 x 12 x 8" H	1 sq. ft.	85 lbs.	12	2	24	24 sq. ft.	2,090 lbs.
Classic 8 Beveled	18 x 12 x 8" H	1 sq. ft.	79 lbs.	12	2	24	24 sq. ft.	1,946 lbs.
Beveled Base	18 x 12 x 8" H	1 sq. ft.	79 lbs.	12	2	24	24 sq. ft.	1,946 lbs.
Half Block	9 x 12 x 8" H	0.50 sq. ft.	39 lbs.	12	1	12	6 sq. ft.	518 lbs.
Corner Block	13 x 5.5 x 8" H	0.72 sq. ft.	40 lbs.	12	1	12	8.64 sq. ft.	530 lbs.

**Notes:** Available by layer or pallet. Limited quantities of Classic 6 in Monterey and Brown, call for availability. To estimate number of units, divide total sq. ft. by 0.75 for Classic 6.

# legend wall

Rockwood Retaining Walls

## Features

- 1 inch setback
- Highest performance wall system

## Colors

- Gray
- Sandstone

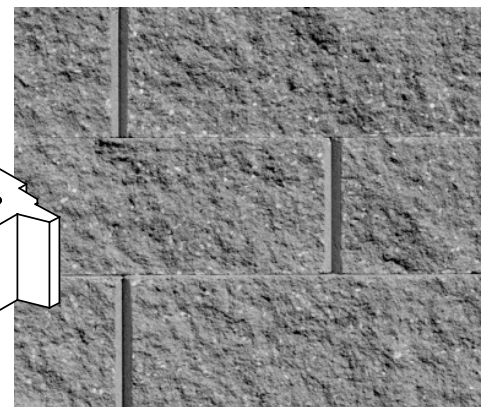
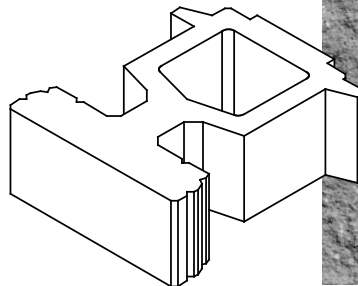

Name	Size W x D x H	Face Area	Weight	Units/Layer	Layers	Units/Pallet	Pallet	Pallet Weight
Straight	18 x 22 x 8" H	1 sq. ft.	131 lbs.	4	4	16	16 sq. ft.	2,146 lbs.
Beveled	18 x 22 x 8" H	1 sq. ft.	125 lbs.	4	4	16	16 sq. ft.	2,050 lbs.

**Notes:** Available by pallet.

# monument HD wall

Rockwood Retaining Walls

## Features

- 1 inch setback
- 1.33 sq. ft. per block

## Colors

- Gray
- Sandstone

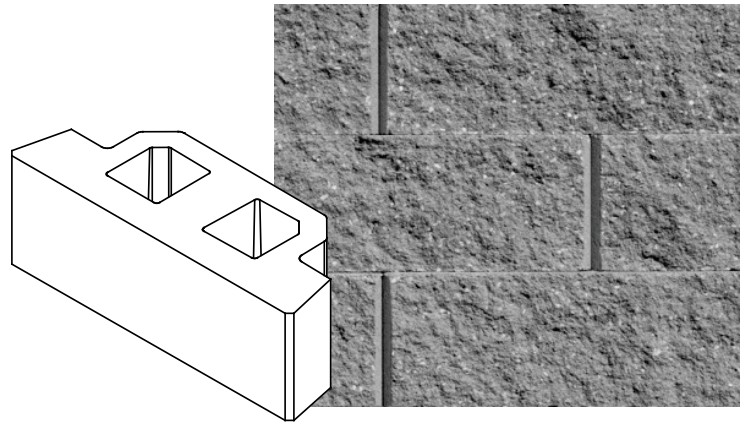

Name	Size W x D x H	Face Area	Weight	Units/Layer	Layers	Units/Pallet	Pallet	Pallet Weight
Straight	24 x 9 x 8" H	1.33 sq. ft.	82 lbs.	8	3	24	31.92 sq. ft.	2,018 lbs.

**Notes:** Available by pallet. Special Order. To estimate number of units, divide total sq. ft. by 1.33.

# sapphire wall

Rockwood Retaining Walls



## Features

- 1 inch setback
- Rear lip

## Colors

- Beechwood
- Sandstone
- Santa Fe

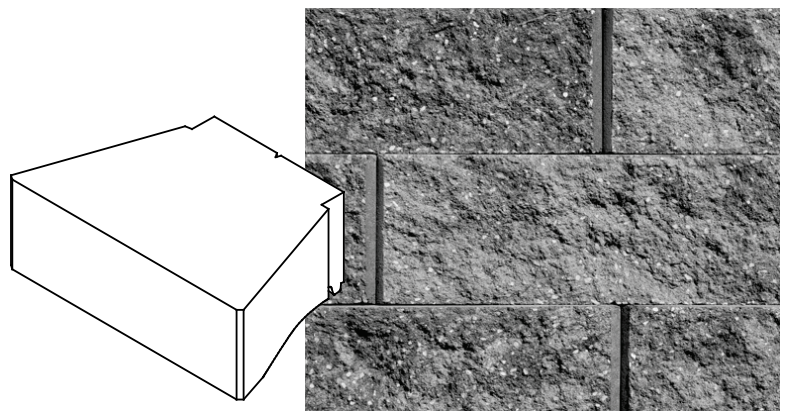

Name	Size W x D x H	Face Area	Weight	Units/Layer	Layers	Units/Pallet	Pallet	Pallet Weight
Straight	17.25 x 12 x 6" H	0.75 sq. ft.	TBD	TBD	TBD	45	33.75 sq. ft.	TBD

**Notes:** Available by layer or pallet.

# premier 8 wall

Rockwood Retaining Walls



## Features

- Less weight than Classic 8
- More blocks per load
- 1 inch setback

## Colors

- Beechwood
- Sandstone
- Santa Fe

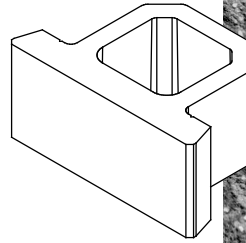

Name	Size W x D x H	Face Area	Weight	Units/Layer	Layers	Units/Pallet	Pallet	Pallet Weight
Straight	18 x 12 x 8" H	1 sq. ft.	54 lbs.	9	4	36	36 sq. ft.	1,994 lbs.

**Notes:** Available by layer or pallet.

# kodah wall

Rosetta

## Features

- The look of handcrafted stone
- Use for retaining, freestanding and garden walls
- ¾ inch setback

## Colors

- Copper Canyon
- Fond du Lac
- Pacific Gray



Name	Size W x D x H	Face Area	Weight	Units/Pallet	Pallet	Pallet Weight
	42 x 10.5 x 6" H	1.75 sq. ft.	200 lbs.			
Wall Pallet	30 x 10.5 x 6" H	1.25 sq. ft.	140 lbs.	18	21 sq. ft.	2,400 lbs.
	21 x 10.5 x 6" H	0.88 sq. ft.	100 lbs.			
	12 x 10.5 x 6" H	0.50 sq. ft.	50 lbs.			
Corner Pallet	21 x 10.5 x 6" H	0.88 sq. ft.	100 lbs.	24	21 sq. ft.	2,400 lbs.

**Notes:** Available by pallet

# belvedere wall

Rosetta

## Features

- 64 unique stone textures look like weathered stone
- Use as: seat walls, pillars or structural retaining walls
- ½ inch setback

## Colors

- Copper Canyon
- Fond du Lac
- Pacific Gray



Name	Size W x D x H	Back	Face Area	Weight	Back sq. ft.	Units/Pallet	Pallet	Pallet Weight
Retaining Wall Pallet	6 x 9 x 3" H	4" W	0.125 sq. ft.	10 lbs.	0.13 sq. ft.	12	27 sq. ft.	2,475 lbs.
	12 x 9 x 3" H	10" W	0.25 sq. ft.	22 lbs.	0.25 sq. ft.	12		
	18 x 9 x 3" H	16" W	0.375 sq. ft.	36 lbs.	0.33 sq. ft.	12		
	6 x 9 x 6" H	4" W	0.25 sq. ft.	21 lbs.	0.17 sq. ft.	12		
	12 x 9 x 6" H	10" W	0.50 sq. ft.	42 lbs.	0.42 sq. ft.	12		
	18 x 9 x 6" H	16" W	0.75 sq. ft.	67 lbs.	0.66 sq. ft.	12		
Corner Pallet	15 x 9 x 3" H	14" W	0.313 sq. ft.	30 lbs.	0.385 sq. ft.	16	24 sq. ft.	1,520 lbs.
	15 x 9 x 6" H	14" W	0.625 sq. ft.	58 lbs.	0.583 sq. ft.	16		

Name	Size W x D x H	Back	Face Area	Weight	Units/Pallet	Pallet	Pallet Weight
Coping (Caps)*	Small	4 x 10.25 x 2.25" H	6" W	0.33 ln. ft.	9 lbs.	24	66 ln. ft. 1,552 lbs.
	Medium	12 x 10.25 x 2.25" H	10" W	1.0 ln. ft.	20 lbs.	24	
	Large	18 x 10.25 x 2.25" H	16" W	1.5 ln. ft.	30 lbs.	12	
	Left End	18 x 10.25 x 2.25" H	17" W	1.5 ln. ft.	29 lbs.	6	
	Right End	18 x 10.25 x 2.25" H	17" W	1.5 ln. ft.	34 lbs.	6	
Pillar cap	27 x 27 x 2.5" H		5.06 sq. ft.	150 lbs.	10	50.6 sq. ft.	1,550 lbs.

**Notes:** Available by pallet. One pallet of corner block builds a 24 x 24 x 36" pillar. \*Caps can only be purchased in 11 lineal feet increments.

# belvedere fire pit kit

Rosetta

Name	Size	Pallet Weight
Fire Pit with Steel Insert	58 x 14.5" H 38" interior dia.	1,275 lbs.

**Notes:** Available by pallet.

# belvedere patterns

Block 1 = 3 H x 6 W x 9" L    Block 2 = 3 H x 12 W x 9" L    Block 3 = 3 H x 18 W x 9" L  
 Block 4 = 6 H x 6 W x 9" L    Block 5 = 6 H x 12 W x 9" L    Block 6 = 6 H x 18 W x 9" L

## Belvedere Retaining Wall Patterns

### 12" High Wall



12" H x 12'6" L – Wall Section Shown = 13.5 sq. ft. (1/2 Wall Pallet)

### 18" High Wall

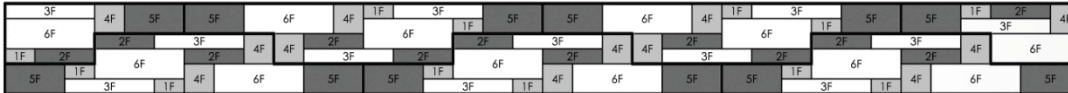

18" H x 18' L Wall Section Shown = 27 sq. ft. (1 Wall Pallet)

### 24" High Wall



24" H x 16' L Wall Section Shown = 32 sq. ft. (Approx. 1.2 Wall Pallets)

## Belvedere Freestanding Wall Patterns

### 24" Pattern A

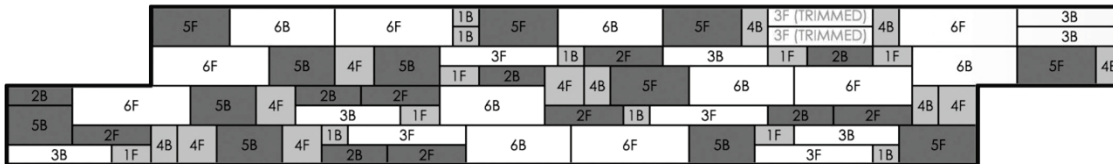

24" H x 14'2" L Wall Section Shown = 24.67 sq. ft. (1 Wall Pallet)

Note: 2" must be trimmed from (2) 3" blocks to make this pattern

### 24" Pattern B

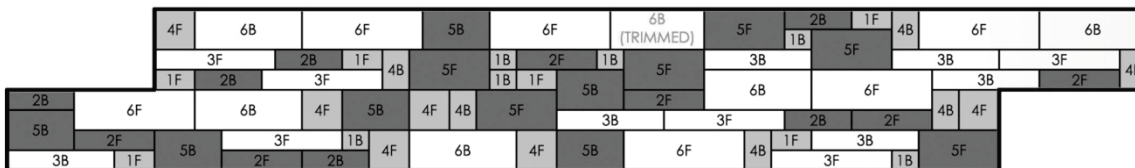

24" H x 14'2" L Wall Section Shown = 24.67 sq. ft. (1 Wall Pallet)

Note: 2" must be trimmed from (1) 6" blocks to make this pattern

### 24" High Vertical End – Left

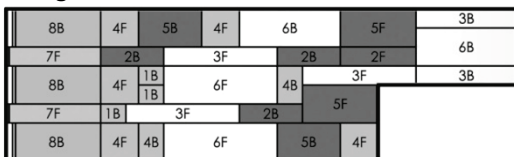

24" H x 6'9" L Wall Section Shown = 11.67 sq. ft. (Approx. 1/2 Pallet)

Note: Vertical End jogs in and out approximately 1" between blocks

### 24" High Vertical End – Right

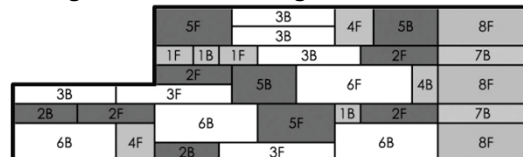

24" H x 6'9" L Wall Section Shown = 11.67 sq. ft. (Approx. 1/2 Pallet)

Note: Vertical End jogs in and out approximately 1" between blocks

# outcropping wall

Rosetta

## Features

- Beautiful weathered stone textures
- Suitable for any application
- Natural color blends
- 3 inch setback

## Colors

- Copper Canyon
- Fond du Lac
- Pacific Gray



Sizes H x W	Pallet	Pallet Weight
Pallet A 12" x 3'6", 12" x 4", 12" x 5', 12" x 5'6"	18 sq. ft.	4,000 lbs.
Pallet B 6" x 2', 6" x 3', 12" x 3', 6" x 4', 12" x 4'6", 12" x 6'	18 sq. ft.	4,000 lbs.
Pallet C 6" x 2', 6" x 3', 18" x 5', 24" x 4'	18 sq. ft.	4,000 lbs.
Corner 30 x 48 x 12" H (3 per pallet)	19.5 sq. ft.	3,650 lbs.

**Notes:** Available by pallet. **Outcropping Lifting Device required - available for purchase or rent. (53 lbs.)**

### 2' x 45'

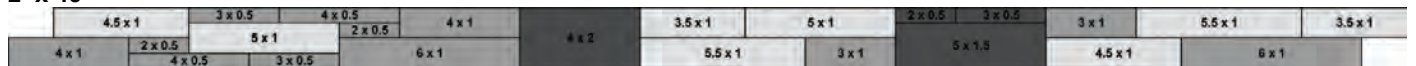

### 3' x 30'

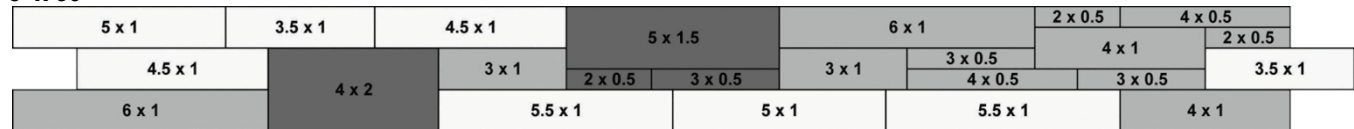

### 4' x 22.5'

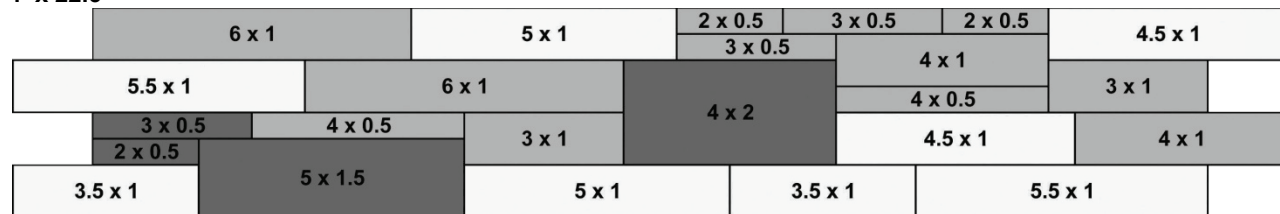

### 5' x 18'

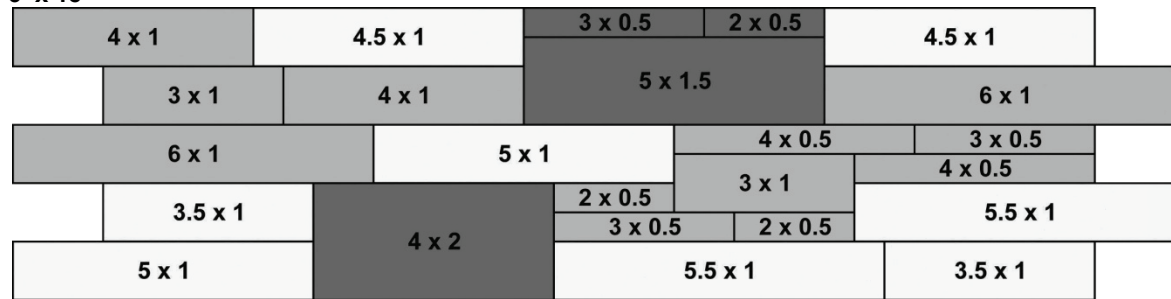

Each pattern is 90 sq. ft. = (2) A pallets + (2) B pallets + (1) C pallet



# dimensional wall

Rosetta

## Features

- 4" height
- Natural textures

## Colors

- Copper Canyon
- Fond du Lac
- Pacific Gray



Name	Size L x W x H	Face Area	Weight	Units/Pallet	Pallet	Pallet Weight
Straight	12 x 8 x 4" H	0.33 sq. ft.	28 lbs.	75	25 sq. ft.	2,140 lbs.
Wedge	12 x 8 x 4" H	0.26 sq. ft.	20 lbs.	100	26 sq. ft.	2,120 lbs.
24" Coping	24 x 12.5 x 2.5" H	2 ln. ft.	63 lbs.	18		
18" Coping	18 x 12.5 x 2.5" H	1.5 ln. ft.	47 lbs.	12	63 ln. ft.	1,491 lbs.
Coping End	19 x 12.5 x 2.5" H	1.6 ln. ft.	49 lbs.	6		

**Notes:** Discontinued, available while supplies last. Call for availability. Available by pallet.

# stonegate country manor wall

Keystone

## Features

- Three-piece, vertical system
- Trapezoidal design
- Split face/tumbled
- Dry stack/pin connection method
- Cap with Vintage or Lakeland

## Colors

- Beechwood
- Bluestone
- Santa Fe



Name	Size W x D x H	Back	Face Area	Weight	Sets/Layer	Layers	Sets/Pallet	Pallet	Pallet Weight
Unit 16/14	16 x 10 x 6" H	14" W							
Unit 12/10	12 x 10 x 6" H	10" W	1.41 sq. ft.	140 lbs.	8	3	24	33.84 sq. ft.	3,250 lbs.
Unit 6/4	6 x 10 x 6" H	4" W							

**Notes:** Available by pallet. 1-2 Shouldered pins required per unit. Available in WI and IL.

# stonegate wall

Keystone

## Features

- Adjustable setback
- Three-piece, vertical system
- Smooth/tumbled
- Dry stack/pin connection method
- Use Vintage or Lakeland for cap

## Colors

- Beechwood
- Bluestone
- Santa Fe



Name	Size W x D x H	Back	Face Area	Weight	Sets/Layer	Layers	Sets/Pallet	Pallet	Pallet Weight
Unit 16/14	16 x 10 x 6" H	14" W							
Unit 12/10	12 x 10 x 6" H	10" W	1.41 sq. ft.	140 lbs.	8	3	24	33.84 sq. ft.	3,250 lbs.
Unit 6/4	6 x 10 x 6" H	4" W							

**Notes:** Available by pallet. 1-2 Shouldered pins required per unit. Available in WI and IL.

# compac wall

Keystone

## Features

- Adjustable setback
- Strong, structural retaining wall system
- Dry stack/pin connection method
- Use Rockwood Universal cap

## Colors

- Sandstone
- Brown
- Gray

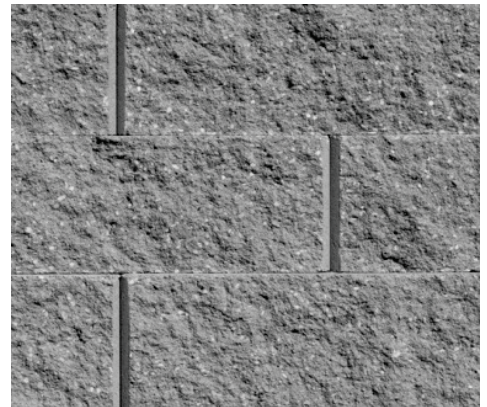

Name	Size W x D x H	Face Area	Weight	Units/Layer	Layers	Units/Pallet	Pallet	Pallet Weight
Straight Split Unit	18 x 12 x 8" H	1 sq. ft.	78 lbs.	9	4	36	36 sq. ft.	2,860 lbs.
Corner Unit	18 x 9 x 8" H	1 sq. ft.	100 lbs.	10	2	20	20 sq. ft.	2,050 lbs.

**Notes:** Available by pallet, Corner unit available by each. 2 Non-Shouldered pins required per unit. Available in WI and IL.

# wall pins

Keystone

Name	Size	Units/box	Pins/pallet
Shouldered pins	½ x 3 ¾" L	100	24,200
Non-shouldered pins	½ x 5 ¼" L	100	24,000

# compac hewnstone wall

Keystone

## Features

- Adjustable setback
- Strong, structural retaining wall system
- Dry stack/pin connection method
- Use Rockwood Universal cap

## Colors

- Beechwood
- Santa Fe



Name	Size W x D x H	Face Area	Weight	Units/Layer	Layers	Units/Pallet	Pallet	Pallet Weight
Straight Split Unit	18 x 12 x 8" H	1 sq. ft.	76 lbs.	9	4	36	36 sq. ft.	2,860 lbs.

**Notes:** Special order. 2 Non-Shouldered pins required per unit. Available in WI and IL.

# standard wall

Keystone

## Features

- Adjustable setback
- Strong, structural retaining wall system
- Dry stack/pin connection method
- Use Rockwood Universal cap

## Colors

- Sandstone
- Gray

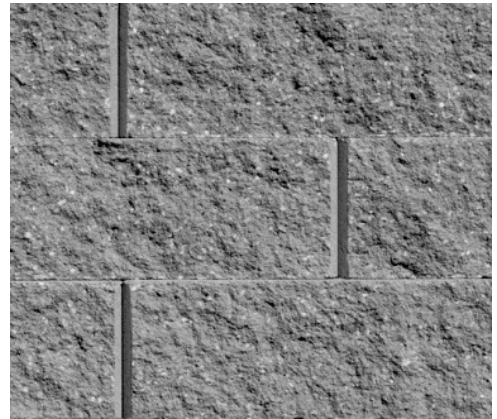

Name	Size W x D x H	Face Area	Weight	Units/Layer	Layers	Units/Pallet	Pallet	Pallet Weight
Straight Split Unit	18 x 12 x 8" H	1 sq. ft.	105 lbs.	9	2	18	18 sq. ft.	1,940 lbs.

**Notes:** Special order. 2 Non-Shouldered pins required per unit. Available in WI and IL.

# cottage stone wall

Rockwood Retaining Walls

## Features

- 1 inch setback

## Colors

- Brown
- Charcoal
- Gray
- Sandstone
- Sandstone Brown

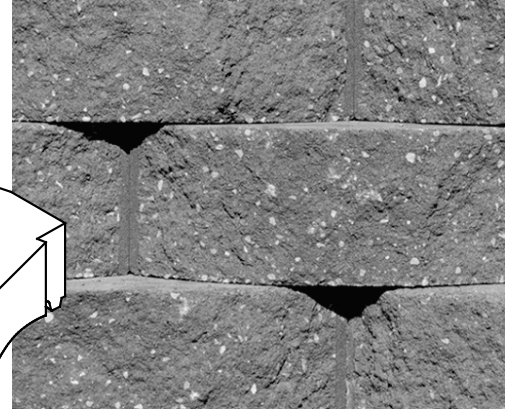
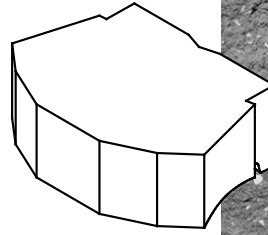

Name	Size W x D x H	Face Area	Weight	Units/Layer	Layers	Units/Pallet	Pallet	Pallet Weight
Beveled	12 x 8.5 x 4" H	0.33 sq. ft.	25 lbs.	16	6	96	31.68 sq. ft.	2,450 lbs.

**Notes:** Available by pallet. To estimate number of units, divide total sq. ft. by 0.33. **Cannot be double stacked.**

# stonehedge 6 wall

Rockwood Retaining Walls

## Features

- Vertical system
- Creates seat walls, enclosures and privacy walls

## Colors

- Bluestone
- Sandstone
- Sandstone Brown
- Santa Fe

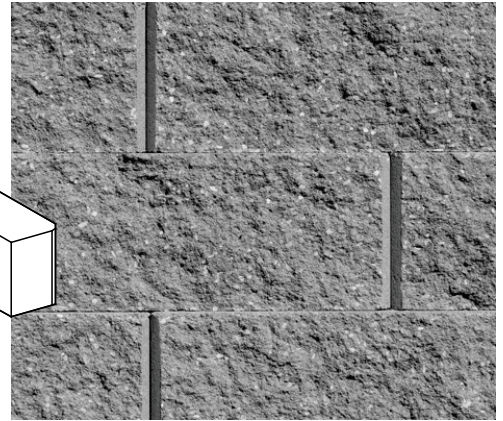
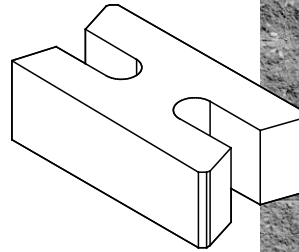

Name	Size W x D x H	Face Area	Weight	Units/Layer	Layers	Units/Pallet	Pallet	Pallet Weight
Straight	18 x 10 x 6" H	0.75 sq. ft.	64 lbs.	8	3	24	18 sq. ft.	1,586 lbs.
Half Unit	6 x 10 x 6" H	0.38 sq. ft.	32 lbs.			12	4.56 sq. ft.	434 lbs.

**Notes:** Available by pallet or layer. To estimate number of units, divide total sq. ft. by 0.75.

# recon wall

## Recon Retaining Walls

### Features

- Depths range 24-84"
- Blocks are 48" W x 16" H
- Available in Le Sueur County Limestone and Weathered Edge Faces

### Colors

- Color stain is applied after construction



Le Sueur County Limestone



Weathered Edge

Name	Size W x D x H	Face Area	Weight
Full Base Block - 24"	48 x 24 x 16" H	5.33 sq. ft.	1,457 lbs.
Full Base Block - 39"	48 x 39 x 16" H	5.33 sq. ft.	2,201 lbs.
Full Base Block - 45"	48 x 45 x 16" H	5.33 sq. ft.	2,491 lbs.
Full Base Block - 60"	48 x 60 x 16" H	5.33 sq. ft.	3,115 lbs.
Full Base Block - 66"	48 x 66 x 16" H	5.33 sq. ft.	
Full Base Block - 72"	48 x 72 x 16" H	5.33 sq. ft.	
Full Base Block - 78"	48 x 78 x 16" H	5.33 sq. ft.	
Full Base Block - 84"	48 x 84 x 16" H	5.33 sq. ft.	4,088 lbs.
Full Top Block - 24"	48 x 24 x 16" H	5.33 sq. ft.	971 lbs.
Regular Corner	48 x 24 x 16" H	5.33 sq. ft.	1,401 lbs.
Corner Top	48 x 24 x 16" H	5.33 sq. ft.	1,103 lbs.
Half Block 24"	48 x 24 x 16" H	5.33 sq. ft.	
Half Block 36"	48 x 36 x 16" H	5.33 sq. ft.	
Capstone	48 x 26 x 6.5" H	2.16 sq. ft.	551 lbs.

### Additional blocks

Full Fence or Full High Cap Block End, Full Fence or Full High Cap Block Top Texture, Half Fence or Half Cap Block End

### Weathered Edge blocks

Full 24", Regular Corner, Corner Top, Half Block (24" or 39" deep), Full Fence or Full High Cap Block End

**Notes:** Installation details at [www.reconwalls.com](http://www.reconwalls.com). Special order for additional textures. Available in IA and WI only.

# stackstone wall

RisiStone

## Features

- Vertical system
- Split-face

## Colors

- Buff/natural
- Brown/buff
- Buff
- Charcoal/natural
- Charcoal/red

## Wide Colors

- Buff/natural
- Brown/buff
- Charcoal/natural

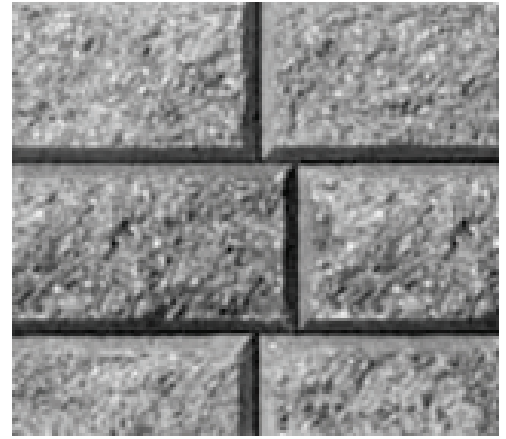

Name	Size W x D x H	Face Area	Weight	Units/Layer	Layers	Units/Pallet	Pallet	Pallet Weight
Standard	8 x 8 x 4" H	0.22 sq. ft.	18 lbs.	20	6	120	26.40 sq. ft.	2,210 lbs.
Wide Standard	12 x 8 x 4" H	0.33 sq. ft.	28 lbs.	15	6	90	29.70 sq. ft.	2,570 lbs.
Coping*	8 x 8 x 4" H	0.22 sq. ft.	18 lbs.	20	6	120	26.40 sq. ft.	2,210 lbs.
Wide Coping*	12 x 8 x 4" H	0.33 sq. ft.	28 lbs.	15	6	90	29.70 sq. ft.	2,570 lbs.

**Notes:** Available by pallet. To estimate number of units, divide total sq. ft. by 0.22.

\*Each layer of coping consists of one corner block that can be split.

# romanstack wall

RisiStone

## Features

- Vertical system
- Weathered look
- Tumbled, split-face

## Colors

- Buff/natural
- Brown/buff
- Charcoal/natural



Name	Size W x D x H	Face Area	Weight	Units/Layer	Layers	Units/Pallet	Pallet	Pallet Weight
Standard	8 x 8 x 4" H	0.22 sq. ft.	18 lbs.	20	6	120	26.40 sq. ft.	2,210 lbs.
Wide Standard	12 x 8 x 4" H	0.33 sq. ft.	28 lbs.	15	6	90	29.70 sq. ft.	2,570 lbs.
Tall	8 x 8 x 8" H	0.44 sq. ft.	34 lbs.	20	3	60	26.40 sq. ft.	2,090 lbs.
Coping	8 x 8 x 4" H	0.22 sq. ft.	18 lbs.	20	6	120	26.40 sq. ft.	2,210 lbs.
Wide Coping	12 x 8 x 4" H	0.33 sq. ft.	28 lbs.	15	6	90	29.70 sq. ft.	2,570 lbs.

**Notes:** Available by pallet. Discontinued, available while supplies last. Call for availability.

# retaining wall material requirements

Use the following methods to estimate the amount of base material, drainage rock, and adhesive you will need for your project.

## 1. Base Material Calculator

A typical trench is 2' wide and 14" deep to bury a full course of 8" block. Your base material must be a minimum of 6" in height.

$$\frac{\text{Wall Length (ft.)}}{\text{Base Height (ft.)}} \times \frac{\text{Base Width (ft.)}}{\text{Base Width (ft.)}} \div 27 = \text{Cubic Yards*}$$

\*Add 10% for inconsistencies in the trench and compaction

## 2. Drainage Rock Calculator

You need enough drainage rock to fill 1' behind the tail of the block and to fill any cores.

$$\frac{\text{Wall sq. ft.}}{\text{Wall sq. ft.}} \times 1.33 \div 27 = \text{Cubic Yards}$$

## 3. Adhesive Calculator

The amount of adhesive required depends on type of block and construction. Use the guide below to estimate the amount of adhesive required.

Approximate length of bead by width:

Tubes	Bead Widths		
	1/8"	1/4"	3/8"
10.5 oz.	129 ft.	32 ft.	14 ft.
29 oz.	355 ft.	89 ft.	39 ft.

Packaging	Tubes	
	10.5 oz.	29 oz.
Tubes/Case	12	12
Cases/Pallet	108	44



# geosynthetic reinforcement – grid tables

## Design Tables for Vintage with Sand Silt ( $\phi = 30^\circ$ ), using SG 200

The design tables were determined using the following assumed soil parameters and conditions:

- Unit weight ( $\gamma$ )=120pcf for all soil types.
- Friction angles ( $\phi$ ): ( $\phi$ )=34° for Silty Coarse Sand (SM-GM), ( $\phi$ )=30° for Silty Sand/Sandy Silt (SM-ML), ( $\phi$ )=28° Clayey Silt/Silty Clay (ML-CL).

Designs assume a 6" compacted base aggregate leveling pad, and a swale directly behind wall. Rockwood's design charts are for preliminary use only.

A final site specific design should be evaluated and approved by a qualified professional engineer.

Tables account for inclined base construction for walls over 3' in height.



Vintage 16" Pattern for Retaining Walls

Level	3:1 Slope	Surcharge: (100 lbs./sq. ft.)
<p>4' Wall (Grid Layers at: 8", 16", 16", 8")</p>		
<p>5'4" Wall (Grid Layers at: 8", 16", 16", 16", 8")</p>		
<p>6'8" Wall (Grid Layers at: 8", 16", 16", 16", 16", 8")</p>		
<p>8' Wall (Grid Layers at: 8", 16", 16", 16", 16", 16", 8")</p>		



# geosynthetic reinforcement – grid tables

Classic 6 and Classic Colonial 6 with Sandy Silt ( $\phi = 28^\circ$ ), using Strata Grid 150

More grid tables available online at [www.rockwoodwalls.com](http://www.rockwoodwalls.com)

## Classic® 6 and Classic Colonial® 6 with Sandy Silt ( $\phi = 28^\circ$ ), using StrataGRID 150

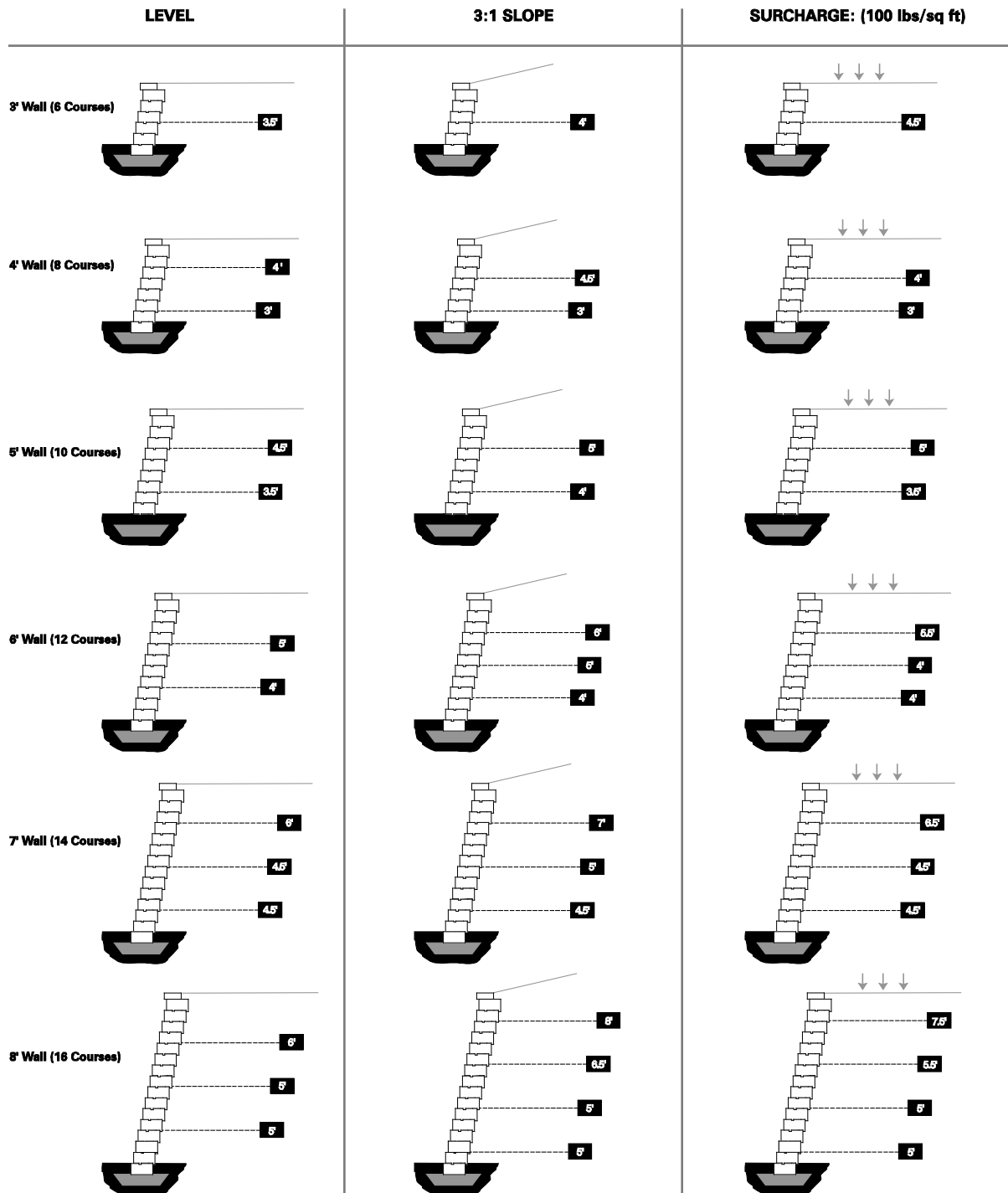

The above design tables were determined using the following assumed soil parameters and conditions:  
 Unit weight ( $\gamma$ )=120pcf for all soil types.  
 Friction angles ( $\phi$ ): ( $\phi$ )=32 degrees for Silty Coarse Sand (SM). ( $\phi$ )=28 degrees for Silty Sand/Sandy Silt (SM-ML). ( $\phi$ )=24 degrees Clayey Silt/Silty Clay (ML-CL).  
 Designs assume a 6" compacted angular aggregate base (road base) leveling pad and swale directly behind wall. Rockwood's design charts are for preliminary use only.  
 A final site specific design should be evaluated and approved by a qualified professional engineer.  
 For positive connection grid tables, consult a qualified professional engineer.

# the kitchen cabinet kits

## Necessaries

### Features

- 13 different cabinet, endless combinations
- 3cm high-grade granite counter tops, choose from Viscont White or Black Pearl
- Premium stainless steel grills and components

### Colors

- Beechwood
- Bluestone
- Desert
- Santa Fe

### Standard Features

- Tumbled Lakeland block
- TiteBond adhesive
- 3cm Granite tops

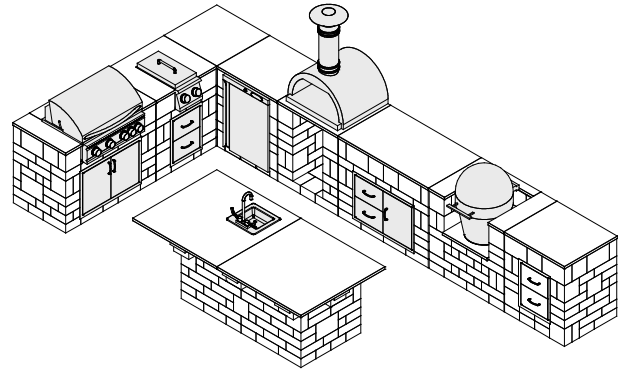

Name	Size W x D x H	Pallets	Weight	Build Time	Details
40" Grill Cabinet	56 x 28 x 37" H	2	2,890 lbs.	6 hrs.	Summerset Sizzler 40" Grill, 30" double doors, grill cover, 12,000 max Btu
32" Grill Cabinet	48 x 28 x 37" H	2	2,535 lbs.	5 hrs.	Summerset Sizzler 32" Grill, 30" double doors, grill cover, 12,000 max Btu
Side Burner Cabinet	32 x 28 x 37" H	2	1,905 lbs.	4 hrs.	Sizzler double side burner, double drawer
Prep Center Cabinet	48 x 28 x 37" H	2	2,270 lbs.	5 hrs.	Double drawer and door combo
Prep Center Cabinet w/Sink	48 x 28 x 37" H	2	2,295 lbs.	6 hrs.	Double drawer and door combo, sink fixture
Refrigerator Cabinet	32 x 28 x 37" H	1	1,035 lbs.	4 hrs.	Refrigerator sold separately
Two Drawer Cabinet	32 x 28 x 37" H	2	1,985 lbs.	5 hrs.	Double drawer
Trash Cabinet	28 x 28 x 37" H	2	1,110 lbs.	3 hrs.	Drawer
Smoker Cabinet	40 x 28 x 37" H	1	2,120 lbs.	4 hrs.	Smoker not available
Woodbox Cabinet	32 x 28 x 37" H	1	1,830 lbs.	4 hrs.	
Outdoor Oven	30 x 32 x 40" H	1	155 lbs.	1 hrs.	Sold separately. 24 x 24 cooking surface, color Hammered Copper
Outdoor Oven Tool Set	Multi size	Box	8 lbs.		Large Pizza Peel: 55 x 11.5" Small Pizza Peel: 51 x 8.5" Oven Brush: 51 x 3" sold as a set.
Corner Cabinet	28 x 28 x 37" H	1	1,935 lbs.	4 hrs.	
Island Cabinet	90 x 45.5 x 37" H	4	4,320 lbs.	8 hrs.	Double drawer and door combo. Base size 65 W x 32.50" D
Island Cabinet w/Sink	90 x 45.5 x 37" H	4	4,335 lbs.	9 hrs.	Double drawer and door combo, sink
Deluxe Rotisserie Kit					Sold separately
Grill Cover					Sold separately

**Notes:** Kits cannot be returned. Full specifications available online at: [www.kitchen.outdoorlivingkits.com](http://www.kitchen.outdoorlivingkits.com)

# outdoor oven

## Necessaries

### Features

- 24" x 24" cooking surface
- Hammered copper color
- Handcrafted in Sicily

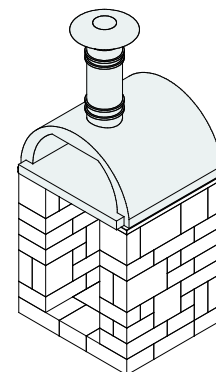

Size	Weight	Details
32"x 30" x 40" H	155 lbs.	#304 stainless steel construction, reinforced, stainless steel chimney pipe, stainless steel wood caddy, stainless steel door & Beechwood handle, and thermometer. Woodbox not included.

# grand fireplace kit

## Necessaries

### Standard Features

- Rockwood Lakeland Block
- Silver Creek chiseled edge mantels/tops in Indiana Limestone color
- TiteBond adhesive 28 oz. tubes
- Easy-to-read course-by-course instructions

### Colors

- Beechwood
- Bluestone
- Desert
- Santa Fe

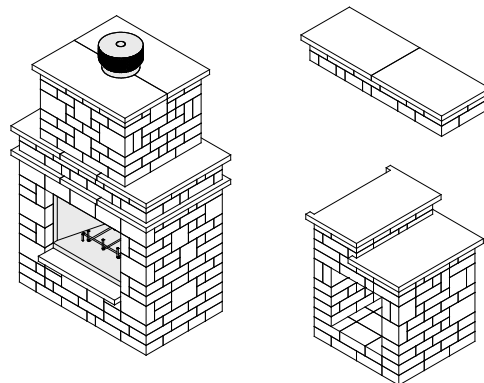

Name	Size W x D x H	Pallets	Weight	Build Time	Details
Grand Fireplace	60 x 36 x 102" H	5	9,677 lbs.	8 hrs.	Lennox Merit plus 36" stainless steel wood burning insert, 4' chimney, spark suppressor, stainless steel log grate and spark curtain. Firebox is 33 W x 16 D x 19" H
Grand Hearth	60 x 20 x 10" H	1	709 lbs.	3 hrs.	
Grand Woodbox	40 x 36 x 50" H	2	4,061 lbs.	1 hr.	Woodbox interior 24 W x 28 D x 24" H

**Notes:** Build time assumes two people with limited skills and base work is complete prior to construction.

# contemporary fireplace kit

## Necessaries

### Standard Features

- Rockwood Lakeland Block
- Silver Creek chiseled edge mantels/tops in Indiana Limestone color
- TiteBond adhesive 28 oz. tubes
- Easy-to-read course-by-course instructions

### Colors

- Beechwood
- Bluestone
- Desert
- Santa Fe

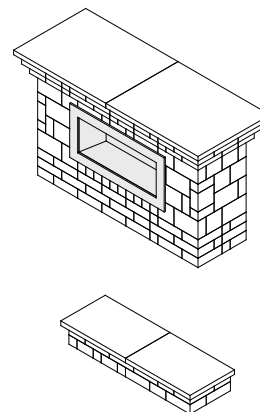

Name	Size W x D x H	Pallets	Weight	Build Time	Details
Contemporary Fireplace	96 x 36 x 54" H	5	4,700 lbs.	6 hrs.	Fire Gear stainless steel gas burning insert, 43,500 max Btu LP, 44,500 max Btu NG, electronic ignition, stainless steel access door
Contemporary Hearth	60 x 20 x 10" H	1	709 lbs.	1 hr.	

**Notes:** Build time assumes two people with limited skills and base work is complete prior to construction.

# victorian fireplace kit

Necessaries

## Standard Features

- Rockwood Lakeland Block
- Silver Creek chiseled edge mantels/tops in Indiana Limestone color
- TiteBond adhesive 28 oz. tubes
- Easy-to-read course-by-course instructions

## Colors

- Beechwood
- Bluestone
- Desert
- Santa Fe

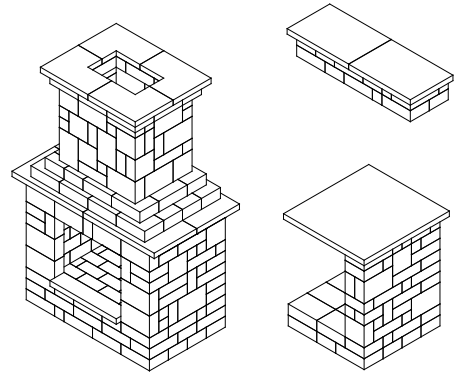

Name	Size W x D x H	Pallets	Weight	Build Time	Details
Victorian Fireplace	52 x 32 x 89" H	5	6,610 lbs.	8 hrs.	2.25" Fire brick, Firebox is 31 W x 17.5 D x 29.5" H
Victorian Hearth	52 x 18 x 10" H	1	580 lbs.	1 hr.	
Victorian Woodbox	32 x 32 x 42" H	2	2,190 lbs.	3 hrs.	Woodbox interior 24 W x 24 D x 32" H

**Notes:** Build time assumes two people with limited skills and base work is complete prior to construction.

# colonial fireplace kit

Necessaries

## Standard Features

- Rockwood Lakeland Block
- Silver Creek chiseled edge mantels/tops in Indiana Limestone color
- TiteBond adhesive 28 oz. tubes
- Easy-to-read course-by-course instructions

## Colors

- Beechwood
- Bluestone
- Desert
- Santa Fe

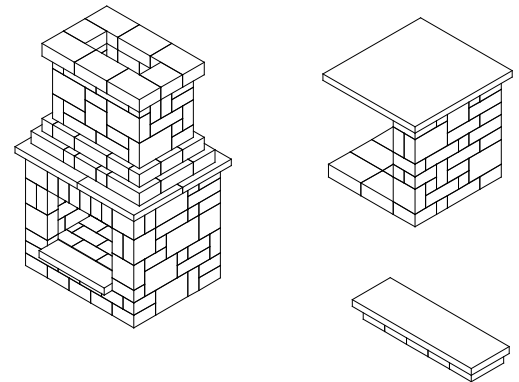

Name	Size W x D x H	Pallets	Weight	Build Time	Details
Colonial Fireplace	40 x 32 x 70" H	2	4,360 lbs.	3 hrs.	2.25" Fire brick. Firebox is 29 W x 18.5 D x 26.5" H
Colonial Hearth	40 x 12 x 6" H	1	295 lbs.	0.5 hr.	
Colonial Woodbox	32 x 32 x 34" H	1	1,665 lbs.	1 hrs.	Woodbox interior 24 W x 24 D x 28" H

**Notes:** Build time assumes two people with limited skills and base work is complete prior to construction.

# oak gas log set

Fire Gear

Name	Size	Package	Weight	Details
Oak Gas Log set	18" W	Box		#304 stainless steel burner and rack, log set, and Thermo couplex. 45,000 max Btu. NG and LP available. Fits Grand, Victorian, Compact and Colonial Fireplaces

# compact fireplace kit

## Necessaries

### Standard Features

- Rockwood Lakeland Block
- Silver Creek chiseled edge mantels/tops in Indiana Limestone color
- TiteBond adhesive 28 oz. tubes
- Easy-to-read course-by-course instructions

### Colors

- Beechwood
- Bluestone
- Desert
- Santa Fe

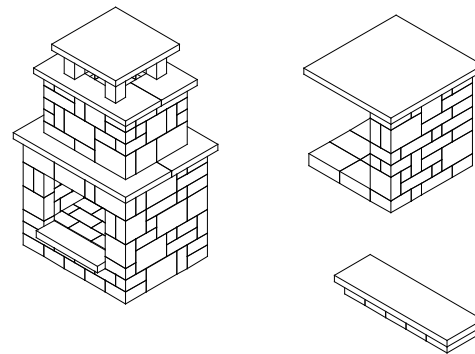

Name	Size W x D x H	Pallets	Weight	Build Time	Details
Compact Fireplace	40 x 32 x 70" H	2	3,735 lbs.	3 hrs.	2.25" Fire brick. Firebox is 29 W x 18.5 D x 26.5" H
Compact Hearth	40 x 12 x 6" H	1	295 lbs.	0.5 hr.	
Compact Woodbox	32 x 32 x 34" H	1	1,665 lbs.	1 hrs.	Woodbox interior 24 W x 24 D x 28" H

**Notes:** Build time assumes two people with limited skills and base work is complete prior to construction.

# seat wall and pillar kits

## Necessaries

### Standard Features

- Rockwood Lakeland Block
- Silver Creek chiseled edge mantels/tops in Indiana Limestone color
- TiteBond adhesive 28 oz. tubes
- Easy-to-read course-by-course instructions

### Colors

- Beechwood
- Bluestone
- Desert
- Santa Fe

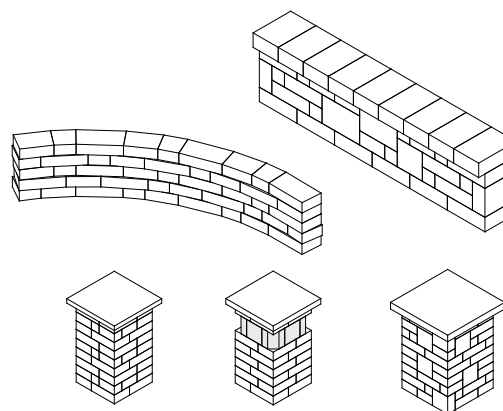

Name	Size W x D x H	Pallets	Weight	Build Time	Details
Lakeland	72 x 8 x 20" H	1	1,075 lbs.	0.5 hr.	Caps sold separately
Riverland	108 x 8 x 20" H	1	1,400 lbs.	0.5 hr.	Riverland block, builds an inside 8 ft. radius caps sold separately
20" Pillar	20 x 20 x 38" H	1	1,260 lbs.	0.5 hr.	25 x 25 x 2.25" top
24" Pillar	24 x 24 x 39" H	1	1,665 lbs.	0.5 hr.	30 x 30 x 2.25" top
20" Pillar w/Glass	20 x 20 x 38" H	1	1,150 lbs.	0.5 hr.	Pittsburg Corning® premier glass block, 25" square top, lightning not included

**Notes:** Build time assumes two people with limited skills and base work is complete prior to construction.

# fire ring kits

## Necessaries

### Standard Features

- Rockwood Lakeland Block
- Silver Creek chiseled edge mantels/tops in Indiana Limestone color
- TiteBond adhesive 28 oz. tubes
- Easy-to-read course-by-course instructions

### Colors

- Beechwood
- Bluestone
- Desert
- Santa Fe

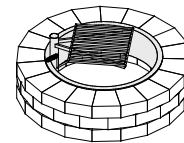
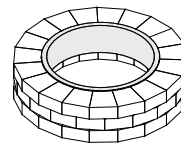
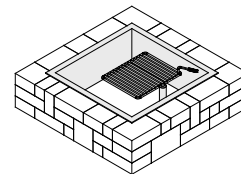
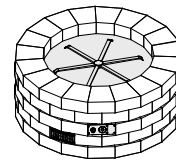

Name	Size W x D x H	Pallets	Weight	Build Time	Details
Grand (block only)	48 x 12" H	1	1,019 lbs.	0.5 hr.	Lakeland fire ring block
Grand	48 x 12" H	1	1,057 lbs.	0.5 hr.	31" interior dia. Heavy grade steel insert
Grand w/Swivel cooking Grate	48 x 12" H	1	1,085 lbs.	0.5 hr.	31" interior dia. Heavy grade steel insert with 300 sq. in. ADA approved swivel cooking grate, removable
Grand (one layer)	48 x 4" H	1	346 lbs.		19 Lakeland fire ring block, one layer
Victorian	48" W x 12" H	1	1,285 lbs.	0.5 hr.	31" interior square, heavy grade steel insert
Victorian w/Swivel Cooking Grate	48" W x 12" H	1	1,310 lbs.	0.5 hr.	31" interior square, heavy grade steel insert with 300 sq. in. ADA approved swivel cooking grate, removable
Grand Gas - NG	48 x 20" H	1	1,710 lbs.	0.5 hr.	Push button ignition, quality stainless steel/brass hardware, includes 50 lbs. black lava rock and vent kit. Max Btu 65,000

**Notes:** Build time assumes two people with limited skills and base work is complete prior to construction.

# fire ring accessories

Name	Size W x D x H	Weight	Details
Fire Ring Cap	10 W x 2.25" H	298 lbs.	Silver Creek chiseled edge in limestone, 32" inside dia. 52" outer dia. Eight pieces per pallet. Available in Indiana Limestone, Bluestone, and Western Buff
Grand Cover	37.9 x 37.9 x 2.88" H	150 lbs.	Heavy galvanized steel
Grand Cover w/Slot	34.8 x 34.8 x 1.88" H	150 lbs.	Heavy galvanized steel. Slotted for use with Swivel Cooking Grate
Grand Swivel Cooking Grate	19.25 x 17.5 x 2" H	10 lbs.	300 sq. in. ADA approved swivel cooking grate, removable
Victorian Swivel Cooking Grate	19.25 x 17.5 x 2" H	10 lbs.	300 sq. in. ADA approved swivel cooking grate, removable
Grand Insert	33.5 x 33.5 x 8.5" H	34 lbs.	Solid 10-gauge steel with 1" top lip, boxed
Victorian Insert	33.5 x 33.5 x 8.5" H	34 lbs.	Solid 10-gauge steel with 1" top lip, boxed
E-Z Access Spark Screen	40 x 18" H	22 lbs.	One spark screen
Conversion Kit – LP			O-Ring conversion to LP
Grand Canyon Gas Log Set	16" H	36 lbs.	9 pc. 16" height of log stack.

**Notes:** Fire Ring Cap CANNOT be double stacked

NEW

# grand island bar and grill kits

## Necessaries

### Standard Features

- Rockwood Lakeland block
- Silver Creek chiseled edge mantels/tops in Indiana Limestone color
- TiteBond adhesive 28 oz. tubes
- Easy-to-read course-by-course instructions

### Colors

- Beechwood
- Bluestone
- Desert
- Santa Fe

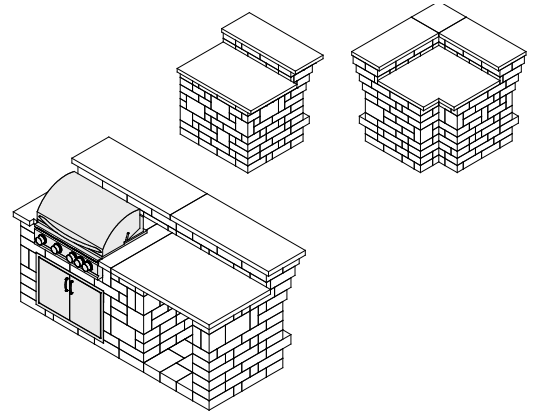

Name	Size W x D x H	Pallets	Weight	Build Time	Details
Grand Island Bar	96 x 48 x 46" H	3	7,271 lbs.	6 lbs.	
Grand Island Bar and Grill with Storage*	96 x 48 x 46" H	4	7,341 lbs.	7 lbs.	3 burner Summerset Sizzler Stainless gas grill, Stainless 30" W x 30" H double door
Grand Island Bar and Grill with Refrigerator Opening	96 x 48 x 46" H	4	7,341 lbs.	7 lbs.	3 burner Summerset Sizzler Stainless gas grill, Stainless 30" W x 30" H door. 24" W x 36" D x 28" H Opening for Refrigerator, <b>Refrigerator not included.</b>
Grand Island Grill Surround	96 x 48 x 46" H	2	4,915 lbs.	4 lbs.	Fits 60" freestanding grill
Grand Island Bar (4ft Section)**	48 x 48 x 46" H	1	3,780 lbs.	4 lbs.	
Grand Island Bar Corner Return***	48 x 48 x 46" H	2	5,140 lbs.	6 lbs.	

**Notes:** \*Please designate LP or NG grill at time of order. \*\* Must specify left side or right side when ordering. \*\*\* Corner return edges are not finished, cannot use alone. Build time assumes two people with limited skills and base work is complete prior to construction.

# compact bar kits

## Necessaries

### Standard Features

- Rockwood Lakeland Block
- Silver Creek chiseled edge mantels/tops in Indiana Limestone color
- TiteBond adhesive 28 oz. tubes
- Easy-to-read course-by-course instructions

### Colors

- Beechwood
- Bluestone
- Desert
- Santa Fe

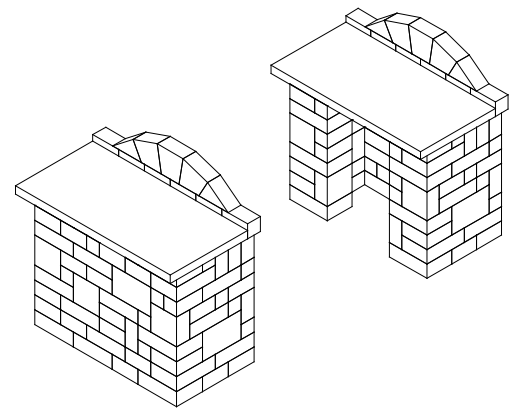

Name	Size W x D x H	Pallets	Weight	Build Time	Details
Compact Bar	48 x 24 x 38" H	1	2,830 lbs.	2 hrs.	Build open or closed front.

**Notes:** Kits cannot be returned. Build time assumes two people with limited skills and base work is complete prior to construction.

# dining and pub table kits

## Necessaries

### Standard Features

- Rockwood Lakeland Block
- Silver Creek chiseled edge mantels/tops in Indiana Limestone color
- TiteBond adhesive 28 oz. tubes
- Easy-to-read course-by-course instructions

### Colors

- Beechwood
- Bluestone
- Desert
- Santa Fe

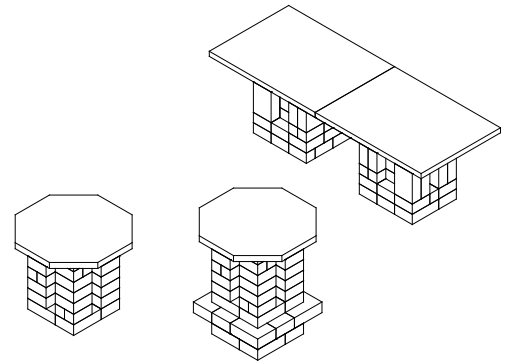

Name	Size W x D x H	Pallets	Weight	Build Time	Details
Dining Table	36 x 96 x 30" H	1	2,870 lbs.	2 hrs.	Seats 8
Pub/Bistro Table	36 x 36 x 42" H	1	1,515 lbs.	1 hr.	Also builds 36 x 36 x 30" H bistro table

**Notes:** Kits cannot be returned. Build time assumes two people with limited skills and base work is complete prior to construction.

# waterfall kits

## Necessaries

### Standard Features

- Rockwood Lakeland Block
- Silver Creek chiseled edge mantels/tops in Indiana Limestone color
- TiteBond adhesive 28 oz. tubes
- Easy-to-read course-by-course instructions

### Colors

- Beechwood
- Bluestone
- Desert
- Santa Fe

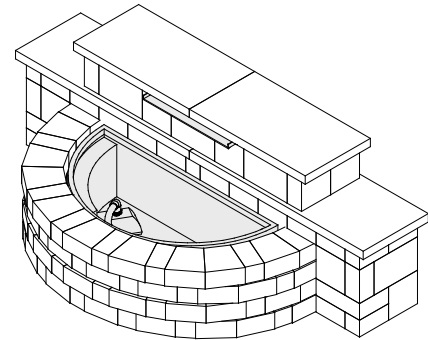

Name	Size W x D x H	Pallets	Weight	Build Time	Details
Grand Water Feature	98" x 48" x 32" H	3	3,475 lbs.	4 hrs.	Includes 1,350 gph mag drive pump, 48" half basin and all connections, 23" stainless steel spillway. Optional light. Rock not included.
Compact Water Feature	64" x 40" x 28" H	1	1,660 lbs.	3 hrs.	Includes 850 gph mag drive pump, 26" square basin and all connections, 11-1/2" stainless steel spillway. Optional light. Rock not included.

**Notes:** Kits cannot be returned. Build time assumes two people with limited skills and base work is complete prior to construction.



# wet cast steps

Silver Creek Stoneworks

## Barn Plank Step Colors

- Cedar
- Espresso

## Travertine Step Colors

- Ivory
- Graphite

## Chiseled Step Colors

- Bluestone
- Fond du Lac
- Indiana Limestone
- Ivory
- Western Buff

Name	Size	Weight	Units/Pallet	Pallet Weight	Details
Barn Plank Step	48 x 18 x 5.75" H	450 lbs.	4	1,850 lbs.	Detailed grain on 5-sides
Travertine Step	48 x 18 x 5.75" H	450 lbs.	4	1,850 lbs.	Detailed texture, honed surfaces
Chiseled Step	48 x 18 x 5.75" H	450 lbs.	4	1,850 lbs.	Options - chiseled face, smooth top or chiseled three sides, rough top

**Notes:** Available by pallet or each. **Chiseled front and Chiseled three sided steps CANNOT be used together.**

# irregular and dimensional steps

Rosetta

## Colors

- Copper canyon
- Fond du Lac
- Pacific Gray

Size	Weight	Units/Pallet	Pallet Weight
Irregular x 7" H	493 lbs.	6	3,008 lbs.
36 x 18 x 7" H	375 lbs.	8	3,050 lbs.
48 x 18 x 7" H	455 lbs.	8	3,690 lbs.
72 x 30 x 7" H	1,320 lbs.	3	4,010 lbs.

**Notes:** Available by pallet. Irregular Steps, 3'6" – 5' widths and 1'10" – 2'4" depths.

# step treads

Rockwood Retaining Walls

## 6" Step Tread Colors

- Gray
- Charcoal
- Sandstone
- Sandstone Brown
- Bluestone
- Santa Fe

## Big Step Colors

- Bluestone
- Gray
- Sandstone
- Sandstone Brown
- Santa Fe

Name	Size	Face Area	Weight	Units/Layer	Layers	Units/Pallet	Pallet	Pallet Weight
6" Step Tread*	8 x 15 x 6" H	0.33 sq. ft.	54 lbs.	18	2	36	11.88 sq. ft.	1,994 lbs.
Big Step	16 x 16 x 6" H	0.37 sq. ft.	123 lbs.	6	4	24	8.88 sq. ft.	3,002 lbs.

**Notes:** Available by pallet or layer. \* Discontinued, available while supplies last. Call for availability. To estimate the 6" step tread, divide sq. ft. by 0.33. To estimate the big step, divide sq. ft. by 0.67.

# stair stacker

Interlock Concrete Products

## Colors

- Brown
- Buff
- Charcoal
- Natural

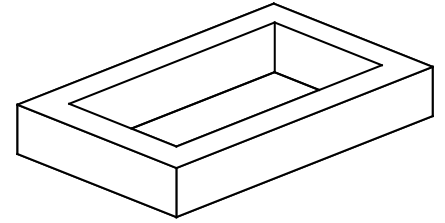

Size	Weight	Interior	Pallet rows	Row weight	Units/Pallet	Pallet	Pallet Weight
36 x 18 x 6.5" H	148 lbs.	2.59 sq. ft.	2	592 lbs.	8	20.72 s. ft.	1,234 lbs.

**Notes:** Available by pallet or row.

# chiseled caps and tops

Silver Creek Stoneworks

## Colors

- Bluestone
- Indiana Limestone
- Western Buff

Name	Size	Face Area	Weight	Units/Pallet	Pallet	Pallet Weight
25" Pillar Cap	25 x 25 x 2.25" H	4.34 sq. ft.	110 lbs.	6	26.04 sq. ft.	710 lbs.
30" Pillar Cap	30 x 30 x 2.25" H	6.25 sq. ft.	125 lbs.	6	37.50 sq. ft.	800 lbs.
25" Pillar Cap	25 x 25 x 3.5" H*	4.34 sq. ft.	194 lbs.	6	26.04 sq. ft.	1,214 lbs.
30" Pillar Cap	30 x 30 x 3.5" H*	6.25 sq. ft.	266 lbs.	6	37.50 sq. ft.	1,646 lbs.
14" Radius Seat Wall Cap	19 x 14 x 2.25" H	1.85 sq. ft.	50.2 lbs.	15	27.75 sq. ft.	803 lbs.
14" Straight Seat Wall Cap, 2-sided	24 x 14 x 2.25" H	2.33 sq. ft.	63.2 lbs.	15	34.95 sq. ft.	998 lbs.
14" Straight Seat Wall Cap, 3-sided	24 x 14 x 2.25" H	2.33 sq. ft.	63.2 lbs.	15	34.95 sq. ft.	998 lbs.
12" Radius Seat Wall Cap	18.75 x 12 x 2.25" H	1.56 sq. ft.	39 lbs.	15	23.40 sq. ft.	635 lbs.
12" Straight Seat Wall Cap, 2-sided	24 x 12 x 2.25" H	2 sq. ft.	53 lbs.	15	30 sq. ft.	845 lbs.
12" Straight Seat Wall Cap, 3-sided	24 x 12 x 2.25" H	2 sq. ft.	53 lbs.	15	30 sq. ft.	845 lbs.
2-sided Bar Top	36 x 48 x 2.25" H	12 sq. ft.	327 lbs.	1	12 sq. ft.	377 lbs.
3-sided Bar Top	36 x 48 x 2.25" H	12 sq. ft.	327 lbs.	1	12 sq. ft.	377 lbs.

**Notes:** Available by pallet or each. Special color runs available with set-up fee, minimum quantities apply. Customer must take 100% of product run. \*Special order.

# stepping stones

Silver Creek Stoneworks

## Colors

- Bluestone
- Fond du Lac
- Western Buff



Average Size	Weight	Sets/Pallet	Pallet	Pallet Weight	
5 ea. of 4 sizes	3.75 sq. ft. x 1.75" H	208 lbs.	5	75 sq. ft.	1,090 lbs.

**Notes:** Available by pallet. **CANNOT be double stacked.**

# bullnose paver

Interlock Concrete Products

## Colors

- Antique Brown
- Beechwood
- Brown
- Charcoal
- Desert Buff
- Onyx
- Santa Fe
- Sierra Gray

Name	Size	Face Area	Weight	Units/Layer	Layers	Units/Pallet	Pallet	Pallet Weight
Tumbled*	12 x 6 x 2.375" H	0.50 sq. ft.	12.64 lbs.	48	3	144	72 sq. ft.	1,870 lbs.
Non-Tumbled	12 x 6 x 2.375" H	0.50 sq. ft.	13.06 lbs.	48	3	144	72 sq. ft.	1,930 lbs.

**Notes:** Available by pallet or layer. \*Allow 2-3 days for tumbling.

# bullet edger

Interlock Concrete Products

## Colors

- Beechwood
- Brown
- Buff
- Carmel
- Charcoal
- Rosewood

Size	Unit In. ft.	Weight	Units/Layer	Layers	Units/Pallet	Pallet In. ft.	Pallet Weight
4 x 12.25 x 4" H	0.9375 In. ft.	14 lbs.	36	5	180	168.75 In. ft.	2,570 lbs.

**Notes:** Available by pallet. To estimate number of units, divide In. ft. by 0.9375.

# classic edger

Rockwood Retaining Walls

## Colors

- Brown
- Charcoal
- Gray
- Red/Black
- Sandstone

Size	Unit In. ft.	Weight	Units/Layer	Layers	Units/Pallet	Pallet In. ft.	Pallet Weight
4 x 10 x 2.75" H	0.83 In. ft.	9 lbs.	48	4	192	160 In. ft.	1,778 lbs.

**Notes:** Available by pallet. Estimate the Classic Edger, divide lineal ft. by 0.83.

# tumbled granite edger

Silver Creek Stoneworks

## Colors

- Bluestone
- Desert
- Santa Fe

Size	Weight	Units/Layer	Layers	Units/Pallet	Pallet	Pallet Weight
12 x 4 x 4" H	16 lbs.	32	5	160	160 In. ft.	2,610 lbs.

**Notes:** Available by pallet.

# tumbled wall caps

Interlock Concrete Products

## Riverland Cap Colors

- Beechwood
- Santa Fe



## Seat Wall Cap Colors

- Bluestone
- Desert
- Santa Fe

Name	Size	Face Area	Weight	Units/Layer	Layers	Units/Pallet	Pallet	Pallet Weight
3" Riverland Cap	15 x 11 x 3" H	1.25 In. ft.	36 lbs.	9	5	45	56.25 In. ft.	1,670 lbs.
13" Seat wall cap	13 x 11.5 x 4" H	1.08 In. ft.	47 lbs.	12	4	48	52 In. ft.	2,306 lbs.

**Notes:** Available by pallet or layer.

# split face wall caps

Rockwood Retaining Walls

## Universal Colors

- Bluestone
- Brown
- Charcoal
- Gray
- Monterey
- Sandstone
- Sandstone Brown
- Santa Fe

## Mini Cap Colors

- Brown
- Charcoal
- Gray
- Sandstone
- Sandstone Brown

Name	Size	Face Area	Weight	Units/Layer	Layers	Units/Pallet	Pallet	Pallet Weight
3" Split Face Cap	12 x 12 x 3" H	1 In. ft.	26 lbs.	12	4	48	48 In. ft.	1,298 lbs.
Universal Cap	18 x 10.50 x 4" H	1.5 In. ft.	54 lbs.	9	4	36	54 In. ft.	1,994 lbs.
Mini Cap	8 x 9 x 3" H	0.67 In. ft.	15.2 lbs.	52	2	104	69 In. ft.	1,630 lbs.

**Notes:** Available by pallet or layer. Estimate Universal Cap, divide wall length by 1.33. Estimate Mini Cap, divide wall length by 0.58.

# granite paver/granite wall accents

Interlock Concrete Products and Rockwood Retaining Walls

## Colors

- Brown
- Desert Buff
- Onyx

Name	Size	Weight	Unit	Units/Layer	Layers	Units/Pallet	Pallet	Pallet Weight
Granite Paver Accent	4 x 8 x 2.375" H	6.75 lbs.	0.22 sq. ft.	80	4	320	70.40 sq. ft.	2,130 lbs.
Granite Wall Accent	12 x 4 x 4" H	16 lbs.	1 ln. ft.	32	5	160	160 ln. ft.	2,610 lbs.

**Notes:** Available by pallet or layer.

# stackstone fire pit

RisiStone

## Colors

- Brown/buff
- Red/charcoal

Name	Size	Pallets	Weight	Includes
Fire Ring Block only	52 x 12" H, 36" interior dia.	1	750	StackStone and Coping units. Two kits per pallet.

**Notes:** Available by pallet or each.

# polymeric sand

Techniseal



Code	Product	Recommended uses	Color	Size	Bags/Pallet
NE91-637	<b>RG+</b>	Narrow joints (1/8–1" wide), light-traffic areas	Prairie Tan	50 lbs. bags	56 units
NE91-647			Prairie Gray	50 lbs. bags	56 units
NE21-848	<b>HP</b>	High-humidity areas, pool decks, wide and false joints (1/8–4" wide), heavily sloped and high-traffic areas	Prairie Tan	50 lbs. bags	56 units
NE21-849			Prairie Gray	50 lbs. bags	56 units

**Notes:** Coverage depends on paver and landscape tile used.

# sealers and cleaners

Techniseal

Code	Product	Size	Units/Pallet	Recommended Uses
T121-393	<b>ProSeries Color Boost Paver Protector (CB)</b> matte finish, water-based, non-film-forming, North American compliant	1 gal.	45 boxes / 180 units	Pool decks, patios, walkways and retaining walls. Enhances the color of pavers with a matte finish.
T121-396		5 gal.	48 units	
T121-313	<b>ProSeries Natural Look Paver Protector (iN)</b> matte finish, water-based, non-film-forming, North American compliant	1 gal.	45 boxes / 180 units	Pool decks, patios, steps, walkways and retaining walls. Invisible matte finish.
T221-316		5 gal.	48 units	
T121-303	<b>ProSeries Clear Look Paver Protector (EV)</b> semi-gloss finish, North America compliant	1 gal.	45 boxes / 180 units	Driveways, walkways and patios. Preserves natural look of pavers with a semi-gloss finish.
T221-306		5 gal.	48 units	
T121-153	<b>ProSeries Protector for WET CAST Pavers</b> wet look, solvent based, North America compliant except for SCAQMD	1 gal.	45 boxes / 180 units	
T121-156		5 gal.	48 units	
T121-143	<b>ProSeries Wet Look Paver Protector (WLWR)</b> gloss finish, solvent-based, film-forming North American compliant except for SCAQMD, CARB, OTC. Not available in IL	1 gal.	45 boxes / 180 units	Driveways, parking lots, patios and walkways. Enhances the color of pavers with a gloss finish
T121-146		5 gal.	48 units	
T121-103	<b>ProSeries Wet Look Recoater Paver Protector (WL5)</b> gloss finish, solvent-based, film-forming north American compliant	1 gal.	45 boxes / 180 units	
T221-106		5 gal.	48 units	
T245-970	<b>ProSeries Surefoot Anti-Slip Grip</b> for solvent based sealers	5.6 oz.	90 boxes/ 540 units	
T121-623	<b>Joint Stabilizing Sealer</b> wet look gloss finish, film-forming, water-based, North America compliant	1 gal.	45 boxes / 180	Stabilizes the aggregates in permeable paver systems. Inhibits the movement of aggregate without impacting the permeability of the joints.
T221-626		5 gal.	48 units	
T121-413	<b>ProSeries Joint Stabilizing Protector,</b> natural look, semi-gloss finish film-forming, water based, North America compliant	1 gal.	45 boxes / 180	
T121-416		5 gal.	48 units	

# applicators

Techniseal

Code	Product	Size	Order Units	Pallets
T145-900	<b>Exact Sprayer for Cleaners</b> for Efflorescence and Hardscape Cleaners		each	60 boxes / 720 units
T145-930	<b>Slit Foam Roller</b>	19 x 240mm	each	30 boxes / 600 units
T145-960	<b>Foam Roller for Water-Based Protector</b>	20 x 240mm	each	31 boxes / 600 units

# cleaners and removers

Techniseal

Code	Product	Size	Pallets	Recommended Uses
T121-591	<b>Professional Grade Oil &amp; Grease Remover</b>	1 qt.	100 boxes / 600 units	Dislodges deeply set petroleum-based products, motor and hydraulic oil.
T121-521	<b>Rust Remover</b>	1 qt.	100 boxes / 600 units	Removes stains caused by steel, rusted metal objects and fertilizers.
T121-541	<b>Paint, Tar and Rubber Remover</b>	1 qt.	100 boxes / 600 units	Dissolves paint, tar or bitumen, rubber and chewing gum.
T121-502	<b>Organic Stain Remover</b>	25 oz.	90 boxes / 540 units	Effectively removes moss, mildew, dead leaves, wine, blood and non-greasy food stains.
T121-534	<b>Paver Prep Heavy Duty Efflorescence Cleaner</b>	1 gal.	36 boxes / 144 units	Prepares the surface before the application of a sealant. Removes efflorescence and ground-in dirt.
T121-536	North American compliant except for SCAQMD	5 gal.	48 units	
T121-604	<b>Paver Restorer</b>	1 gal.	36 boxes / 144 units	Removing cement slurry and polymeric sand haze on concrete or clay pavers and slabs.
T291-606	North American compliant	5 gal.	48 units	
T221-596	<b>Eco Stripper</b>	5 gal.	48 units	For safe removal of most water-based and solvent-based paints, sealers and stains.

**Notes:** Coverage depends on paver and landscape tile used.

# sealer quick reference guide

Techniseal

Applications	Wet Look			Natural Look	Clear Look	Color Boost	Brick & Concrete Waterproofing
	Wet Cast	WL5	WLWR	iN	EV	CB	WR7
Concrete, pavers and slabs		•	•	•	•	•	
Natural stone (unpolished)			•	•	•	•	
Colored stamped concrete	•		•	•	•	•	
Retaining walls				•		•	•
Poured concrete/ wet cast slabs	•						
<b>Technical Features</b>							
Film-forming		•	•		•		•
Non-film-forming				•		•	
Water-based				•	•		•
Solvent-based	•	•	•			•	
Coverage sq. ft. /gal.	Up to 150	Up to 150	Up to 150	Up to 120	Up to 175	Up to 120	Up to 150
Can recoat	Wet Cast	WL5, WLWR	WLWR	iN	EV	CB	WR7 after minimum of 5 years

**Limited Warranty:** Manufacturer, having no control over the use of the materials, does not guarantee finished work. Replacement of any defective product shall be the buyer's sole remedy under this warranty. Proof of purchase will be required for any claim. Before using this product, user shall determine the suitability of the product for its intended use and user alone assumes all risks and liability whatsoever in connection therewith. User shall test product in a small inconspicuous area (approx. 4 sq. ft.) under projected conditions of use. In the event that no test was carried out, the warranty will only apply to 4 sq. ft. This limited warranty excludes any liability for any consequential, incidental, indirect or special damages. Except for the limited warranty made above, manufacturer specifically disclaims and excludes any other express warranty, any implied warranty of merchantability of goods and implied warranty of fitness of goods for any particular purpose.

# polymeric sand

Alliance Gator



Item	Name	Application	Colors	Size	Pallet
Supersand001b			Beige Sand		
Supersand002g	Supersand Bond HP	Normal	Slate Gray	50 lb.	56
Supersand004bd			Black Diamond		
Gator001	Gator Dust Bond	Large Joint	Slate Grey	50 lb.	56
Gator002			Sahara Beige		
Gatormaxx01	Gator Maxx	Overlay	Slate Grey	50 lb.	56
Gatormaxx02			Sahara Beige		

# cleaners, sealers and accessories

Alliance Gator

Item	Product	Size	Units	Pallet
Gatorclean03	<b>Gator Clean Efflorescence Cleaner</b>	1 gal	Box (4)	24 boxes
Gatorclean03		5 gal	Pail	48 Pails
Gatorseal06	<b>Gator Seal Satin Look</b> solvent base	1 gal	Box (4)	24 boxes
Gatorseal05		5 gal	Pail	48 Pails
Gatorseal02	<b>Gator Seal Wet Look</b> solvent base	1 gal	Box (4)	24 boxes
Gatorseal01		5 gal	Pail	48 Pails
Gatorseal04	<b>Gator Seal Natural Look</b> water base	1 gal	Box (4)	24 boxes
Gatorhybrid40		<b>Gator Hybrid Enhancer</b>	1 gal	Box (4)
Gatorhybrid41	low gloss, water base	5 gal	Pail	48 Pails
Gatorseal50	<b>Gator Seal Natural Stone Enhancer</b> zero gloss, water base	1 gal	Box (4)	24 boxes
Gatorseal60		<b>Gator Seal Wet Cast Sealer</b>	1 gal	Box (4)
Gatorseal61	zero gloss, water base	5 gal	Pail	48 Pails
Gatorseal70	<b>Gator Seal Wet Cast Sealer</b> Low Gloss + Enhancer, solvent base	1 gal	Box (4)	24 boxes
Gatorseal71		5 gal	Pail	48 Pails

Item	Product	Units	Pallet
Nail com 10	<b>Nails Common 10"</b>	180/box	48 boxes
Gatorscrew001	<b>Gator Screws</b> use with Gator Tile Edging	50/pack	20 packs
Gatorbase01	<b>Gator Base</b>	23.5" W x 35.5" L 8 ft. pc.	120 (10/pack) 28 bundles
Gatoredge01	<b>Gator Edge Rigid</b>	24 pc./bundle	(5,376 In. ft.)

# edging

Snap Edge

Item number	Product	Details
esepr96-672	Paver Edge Restraint 8'	24 pcs per Bundle, 28 bundles per Pallet
eselp80-672	Low Profile 6' 8"	Low Profile
eper960-64	Permedge 8'	64 per pallet
ssbr10-150-048	10" spikes	150 per Box, 48 Boxes per Pallet



# adhesive

Super-Stik

<b>Item number</b>	<b>Product</b>	<b>Details</b>
1140001	10.5 oz. Adhesive	12 per case / 108 cases per pallet
1140002	29 oz. Adhesive	12 per case / 44 cases per pallet

# geo-grid rolls

Strata and GeoStar

<b>Item number</b>	<b>Product</b>	<b>Size</b>	<b>Weight</b>	<b>Coverage</b>
1178100	Strata Dealer Rolls	4 x 50'		22.22 sq. yd.
1178010	Strata 200	6 x 300'	95 lbs.	200 sq. yd.
1178300	Strata 350	6 x 300'	100 lbs.	200 sq. yd.
HP200	GeoStar HP 200	8.2 x 220'	118 lbs.	200.3 sq. yd.
HP300	GeoStar HP 300	8.2 x 220'	134 lbs.	200.3 sq. yd.

# sleeve-it

Strata

<b>Item number</b>	<b>Product</b>	<b>Order Units</b>
SI-1124R	Sleeve-It (w/Reinforcement)	Minimum of 4

# ROCHESTER CONCRETE PRODUCTS, LLC

## LIMITED LIFETIME WARRANTY

Congratulations on choosing Rochester Concrete Products, LLC ("RCP") products to protect and beautify your home. These superior-quality hardscape products have been designed to give you years of enjoyment and comfort.

**IMPORTANT NOTICE:** Read this entire RCP Limited Lifetime Warranty and Limitation of Liability ("Limited Warranty"). It is important that the warranted products be properly installed and maintained in order for them to function successfully throughout the duration of this Limited Warranty. Depending on the product's application, installation guides can be found at [www.rochesterpcp.com](http://www.rochesterpcp.com). It is also important for your installer to carefully review the technical information, including specifications, for the chosen use of your RCP products as it may be the responsibility of the installer or design engineer to provide independent soil testing, quality assurance inspection, testing, and design services necessary to insure a safe and functional application.

This Limited Warranty applies only to RCP products that are purchased and used as part of Rockwood Retaining Wall Systems installed in owner-occupied single-family homes within the United States, subject to the stated conditions and limitations. This Limited Warranty does not extend to any current or future products distributed, but not manufactured, by RCP. This Limited Warranty applies only to RCP's products and not to the system into which they may be placed. Nor does this Limited Warranty cover to RCP products used in governmental, commercial, or multi-residential applications.

### LIMITED LIFETIME WARRANTY FOR RCP PRODUCTS INSTALLED IN OWNER-OCCUPIED SINGLE-FAMILY HOMES AS A PART OF A ROCKWOOD WALL OR HARDSCAPE SYSTEM.

RCP warrants that its products will be free from defects for as long as you own your home. If RCP is given prompt notice of a defect, it shall, at its sole option: (1) repair or replace the defective product(s), or (2) refund the original purchase price of the defective product(s). This Limited Lifetime Warranty is provided only to the owner(s) of the home at the time of purchase and may not be assigned or transferred. In the event the owner(s) sells the home, this warranty automatically converts to a two-year limited warranty affording the same scope of protection and governed by the same conditions, disclaimers and limitations of this Limited Lifetime Warranty. If RCP elects to repair the defect, it shall be responsible for the labor to accomplish the repair. If RCP elects to replace the defective product(s), its obligation is to deliver suitable replacement product to owner's property.

### LIMITATION OF LIABILITY

This Limited Warranty sets forth the maximum liability for our products. IN NO EVENT (INCLUDING WHERE THIS LIMITED WARRANTY IS DEEMED NOT TO APPLY TO THE SALE OR PRODUCT IN QUESTION) SHALL RCP, GLS INDUSTRIES, INC., OR ROCKWOOD RETAINING WALLS, INC. BE LIABLE FOR ANY INCIDENTAL, CONSEQUENTIAL OR SPECIAL DAMAGES RESULTING FROM THE SALE, INSTALLATION OR USE OF ANY RCP PRODUCTS. Some states do not allow the exclusion or limitation of incidental or consequential damages for consumers, so the above limitation or exclusion may not apply to you.

### LIMITATION OF WARRANTY

RCP MAKES NO OTHER WARRANTIES, EXPRESS OR IMPLIED, INCLUDING ANY IMPLIED WARRANTIES FOR MERCHANTABILITY, FITNESS FOR A PARTICULAR PURPOSE OR OTHERWISE.

### DISCLAIMER – WHAT THIS LIMITED WARRANTY DOES NOT COVER

RCP is not responsible for or makes no warranty as to:

1. Product failure, loss or damage due to:
  - Normal wear and tear;
  - Damage due to improper handling and repeated or extended contact with chemicals, such as deicers;
  - Products improperly installed or maintained;
  - Acts of God;
  - Structural settlement, movement or vibration;
  - Products that have not been paid for in full.
2. Minor imperfections
  - Minor imperfections that do not affect the product's structural integrity;
  - Variations in product texture or color;
  - Efflorescence;
  - Minor imperfections in shape, appearance, or dimensions covered by ASTM C1372.

### CONDITIONS OF WARRANTY – WHAT YOU MUST DO TO RECOVER UNDER THIS LIMITED WARRANTY

Prompt Notice of Defect:

Within the warranty period, you must promptly, and in no case more than one (1) year after any defect or other basis of a claim covered by this Limited Warranty is discovered or should have been discovered, notify RCP of the defect. Any claims otherwise covered by this Limited Warranty, but for which RCP did not receive notice of the defect within one (1) year from the time the problem first became known shall be barred.

### LIMITED WARRANTY CLAIM PROCEDURE

Claims under this Limited Warranty may be made in writing to RCP at 7200 N. Hwy. 63, Rochester, MN, 55906. Claims should include the following information:

1. Claimant's name, address, and phone number and the installation address (if different);
2. A description of the product, purchase price, date and location of purchase, and copies of invoices, if available;
3. A description of the defect(s) (photos are required); and
4. A brief summary of attempts made to address the concerns.

### NO STATEMENT OF USEFUL LIFE

This Limited Warranty is not a statement of the useful life of any RCP products.

dms.us.51883281.01

# GENERAL TERMS AND CONDITIONS OF SALE

These General Terms and Conditions of Sale (these "Terms and Conditions") will apply to the sale of goods and any (if any) applicable services (collectively, with any such services, being the "Goods") pursuant to any contract (a "Contract") to which these Terms and Conditions are made applicable. As used in these Terms and Conditions, "we," "us," "our" and similar terms refer to Rochester Concrete Products, LLC, and "Customer" means the party purchasing the Goods from us.

**Alteration.** No provision in these Terms and Conditions may be varied or waived except by a writing signed by us specifically referring to these Terms and Conditions and describing such variance or waiver. Our acceptance or acknowledgement of Customer's purchase order or any other document pertaining to the Goods, even if in writing and signed by us, will not be deemed an acceptance of any provision of Customer's purchase order or any other document that conflicts with or adds to these Terms and Conditions, absent a separate agreement in writing signed by us expressly acknowledging and agreeing to such provisions. Without limiting the generality of the foregoing, we object to any different or additional terms or conditions contained in any request for quotation, purchase order or other document of Customer, and no such terms will be effective or binding upon us unless we agree to such terms in a writing signed by one of our officers. In no event will our delivery of any Goods be an assent to any such terms proposed by Customer. Unless otherwise expressly stated in any applicable quotation or comparable document signed by us, we may revoke any quotation or other offer at any time prior to acceptance, and no such quotation or other offer will be valid for more than 30 days. After acceptance of an order, Customer may not cancel or terminate any Contract without our consent, except as provided herein or by applicable law.

**Payment; Delivery.** All prices are quoted and all payments will be made in U.S. Dollars. Customer will pay our invoices IN FULL on the terms stated in the applicable invoice, without set-off or counterclaim. Past due invoices will bear a late fee of 1.0% per month or, if less, the highest rate permitted by applicable law. Any stated shipment or delivery date is the date on which we in good faith believe the Goods will be shipped, but failure to ship on that date will not be a breach of the Contract, whether such Goods are in fact shipped before or after that date. All Goods are shipped Ex Works (Incoterms 2010) at our facilities, and costs of transportation and risk of loss during shipment will be borne by Customer. We may deliver any Goods hereunder in installments, in which case each installment will be treated as a separate sale hereunder and may be separately invoiced. Customer will pay all duties and sales, value-added, excise, use or other taxes arising in connection with any transaction (other than taxes based solely on our taxable income). Unless otherwise specified, Goods will be shipped in packaging we reasonably select.

**Duty to Inspect.** Customer will inspect all Goods promptly upon delivery and notify us promptly upon becoming aware of any non-conformity to the Contract. Except as stated regarding any applicable written warranty, we will have no liability regarding any such non-conformity unless such notice is given to us no later than (i) for a defect that could be determined by inspection upon delivery, the 30th day after delivery of such Goods, or (ii) for any other defect, the 30th day after such defect should reasonably have been discovered by Customer, but in each event not later than the 60<sup>th</sup> day after delivery of the Goods to Customer. Shipments less than 5% over or under the quantity specified in the Contract will be deemed in conformance with the Contract. Goods will not be deemed non-conforming solely by reason of minor modifications or changes in materials from those specified in the Contract, so long as such modifications and changes do not materially and adversely affect the performance of the Goods. If the Goods do not conform to the Contract, our obligation will be limited to, at our election, supplying the missing Goods, replacing the relevant Goods, or refunding the purchase price paid for such Goods (but in all cases as otherwise may be limited in any other Paragraph of these Terms and Conditions or the Contract).

**Security Interest.** We reserve, and Customer hereby grants to us, a security interest in all Goods. That security interest secures all present and future obligations of Customer to us, including but not limited to the obligation to pay the price of the Goods. We may make any such filings as reasonably necessary to perfect such security interest (and Customer will cooperate promptly in all reasonable respects in connection therewith).

**Our Warranty.** Customer will ensure that any written warranty that we provide with the Goods is properly given to the end user of the Goods (whether by providing such warranty directly or causing Customer's contractors to do so).

**Limited Warranty.** We make no warranty of any nature whatsoever with respect to the Goods, other than any written, limited warranty that we may provide at the time we provide the Goods. If Customer discovers any breach of or similar creation of obligation under the warranty described above, Customer must notify us in writing thereof within 30 days after such discovery. Within a reasonable time following such notification, we will determine whether such warranty in fact applies and will, at our option, either (i) repair or replace the applicable Goods, (ii) remit to Customer the purchase price paid for such Goods, or (iii) take any other action consistent with the terms of such warranty. THE FOREGOING WARRANTIES ARE EXCLUSIVE. WE MAKE NO OTHER WARRANTY, EXPRESS OR IMPLIED, INCLUDING BUT NOT LIMITED TO ANY IMPLIED WARRANTY OF MERCHANTABILITY, NON-INFRINGEMENT OR FITNESS FOR A PARTICULAR PURPOSE. THE REMEDIES SET FORTH IN THIS PARAGRAPH ARE THE EXCLUSIVE REMEDY FOR ANY BREACH OF OR SIMILAR CREATION OF OBLIGATION UNDER WARRANTY. The remedies set forth in this Paragraph will not be deemed to have failed of their essential purpose so long as we are willing and able to provide one of the applicable remedies set forth herein.

**Limitations.** WITHOUT LIMITING ANY OTHER LIMITATION OF LIABILITY, IN NO EVENT WILL WE BE LIABLE FOR ANY INCIDENTAL, INDIRECT OR CONSEQUENTIAL DAMAGES OF ANY KIND, WHETHER FOR BREACH OF ANY WARRANTY, BREACH OR REPUDIATION OF ANY OTHER TERM OR CONDITION, NEGLIGENCE, STRICT LIABILITY, OR OTHERWISE. IN NO EVENT WILL OUR AGGREGATE LIABILITY TO, THROUGH OR ON BEHALF OF CUSTOMER IN ANY WAY RELATED TO THIS OR ANY RELATED TRANSACTION EXCEED THE TOTAL AMOUNT PAID TO US UNDER THE APPLICABLE CONTRACT.

**Force Majeure.** We will not be liable for any failure to manufacture, deliver or provide, or for any delay in the manufacture, delivery or provision of, any Goods if such failure or delay is caused by act of God, fire, strike, blackout, labor difficulty, riot, inability to obtain raw materials, supplies or other goods or services, equipment, labor or transportation, governmental restrictions, public health nuisance, or similar cause over which we are unable to exercise adequate control. We may cancel any Contract by notice to Customer if we determine in good faith that any such cause makes performance of the Contract impossible or commercially impracticable for us.

**Confidential Information.** "Confidential Information" means information that you obtain from or regarding us regarding our products, business practices, customers, assets or other matters, excluding any information that is publicly available when provided or thereafter becomes publicly available, other than by reason of your breach hereof. You will (i) not use any Confidential Information other than for the performance of any Contract, (ii) not disclose Confidential Information, except to your employees and contractors requiring such information for the performance of any Contract, (iii) use your best efforts to prevent your employees, your contractors, and your contractors' employees from using or disclosing Confidential Information to any party, except as permitted by this Paragraph, and (iv) return all Confidential Information to us upon our request following completion or termination of any Contract. This Paragraph (and all related rights and remedies) will survive performance or termination of any Contract.

**Miscellaneous.** All rights and obligations under these Terms and Conditions and any Contract will be governed by the laws of the State of Minnesota (without regard to principles of conflicts of law). The headings herein are for convenience of reference only and will not affect any meaning or interpretation. The United Nations Convention on Contracts for the International Sale of Goods will not apply. CUSTOMER HEREBY IRREVOCABLY SUBMITS TO THE EXCLUSIVE JURISDICTION OF ANY COURT SITTING IN HENNEPIN COUNTY, MINNESOTA, IN ANY PROCEEDING ARISING OUT OF OR RELATING TO THE INTERACTIONS BETWEEN US AND CUSTOMER AND TO THE RESPECTIVE COURT TO WHICH AN APPEAL OF THE DECISIONS OF ANY SUCH COURT MAY BE TAKEN, AND CUSTOMER AGREES NOT TO COMMENCE, OR COOPERATE IN OR ENCOURAGE THE COMMENCEMENT OF, ANY SUCH PROCEEDING, EXCEPT IN SUCH A COURT. CUSTOMER HEREBY IRREVOCABLY WAIVES, TO THE FULLEST EXTENT IT MAY DO SO, THE DEFENSE OF AN INCONVENIENT FORUM TO THE MAINTENANCE THEREIN OF SUCH A PROCEEDING. CUSTOMER HEREBY AGREES THAT A FINAL JUDGMENT IN ANY SUCH PROCEEDING WILL BE CONCLUSIVE AND MAY BE ENFORCED IN ANY JURISDICTION BY SUIT ON THE JUDGMENT OR BY ANY OTHER MANNER PROVIDED BY APPLICABLE LAW. CUSTOMER HEREBY EXPRESSLY WAIVES ANY RIGHT IT MAY HAVE TO A JURY TRIAL IN ANY SUCH PROCEEDING. NO CLAIM OR ACTION, REGARDLESS OF FORM, ARISING OUT OF THE INTERACTIONS BETWEEN US AND CUSTOMER MAY BE BROUGHT BY OR ON BEHALF OF CUSTOMER MORE THAN ONE YEAR AFTER THE CAUSE OF ACTION HAS ACCRUED (SUBJECT TO ANY FURTHER APPLICABLE LIMITATION). IF ANY SUCH LEGAL ACTION IS BROUGHT, THE PREVAILING PARTY WILL BE AWARDED REASONABLE ATTORNEYS' FEES IN ADDITION TO ANY OTHER RELIEF THAT MAY BE GRANTED. Version 3/20/13

## classic 6 & 8 walls - half, base and corner blocks

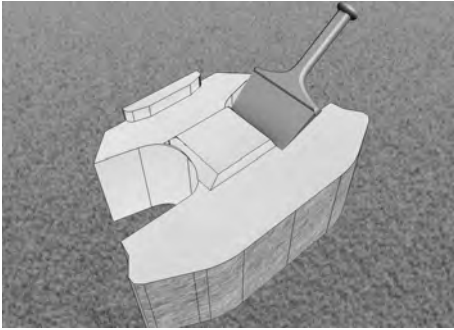

**To create a Base Block**, position the block so the Anchor Bar is facing up. Remove the Anchor Bar with a hammer and chisel as shown – wear protective equipment when modifying the block.

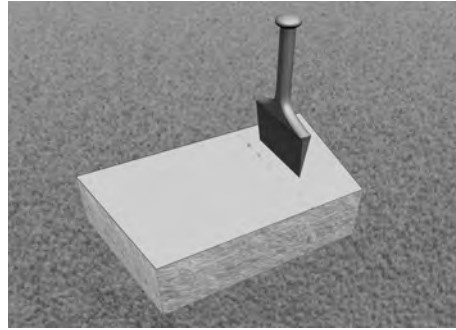

**To create a Half Block**, make a score line in the middle of the block, from front to back and on both sides. Split as shown. Wear protective equipment when splitting.

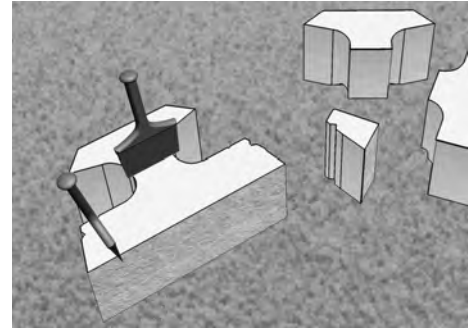

**To create a Corner Block**, make score lines on both splitting grooves and behind the head of the block. Split the block on both top and bottom sides, as shown. A hammer and chisel, or a hand splitter may be used to create the block. Wear protective equipment when splitting.

## classic 6 & 8 walls - basic installation

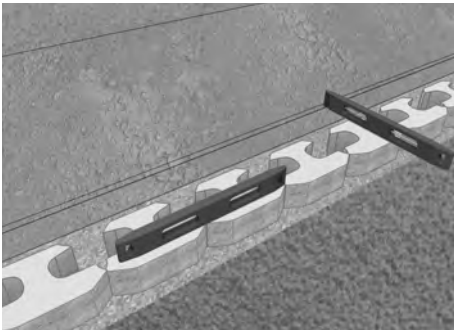

### Base Course Installation

The base course will consist of base block. Use a string line behind the tail of the block for alignment on straight wall applications. All blocks should rest firmly on the pad and be centered to allow 6" of base material in front and 6" behind the Base Block. Level each block, side-to-side, front-to-back and across three full blocks with a hand level. A rubber mallet may be used to level and align the blocks.

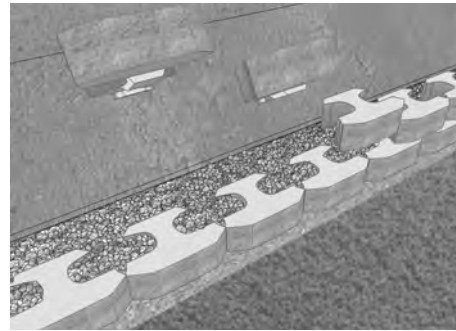

### Core and Drainage Fill

Place 3/4" to 1" clean aggregate (crushed rock) within the cores and a minimum of 12" behind the blocks. This creates a drainage zone and Stone Columns that helps to unify and maximize the performance of the wall.

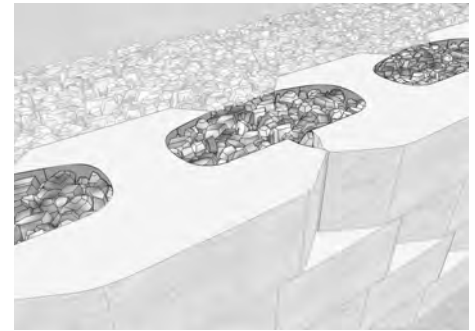

*"Stone Columns" are an integral part of a Rockwood Retaining wall; adding support and stability to the wall.*

## classic 6 & 8 walls - stepping a wall

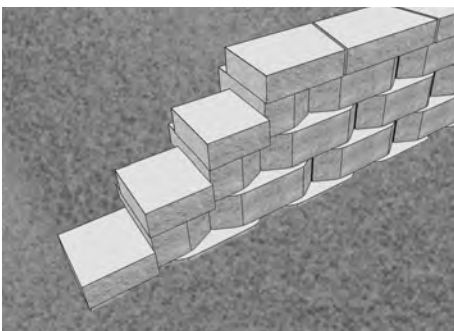

A Half Block or Corner Block may be used to end a course in a Rockwood application.

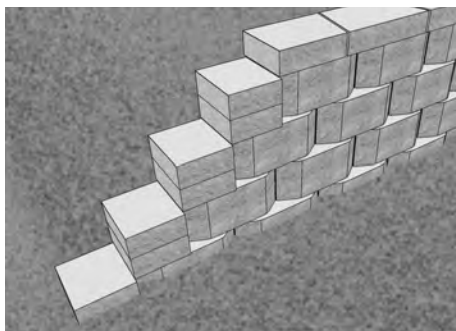

Double stack 4" tall Universal Caps as an end cap to finish courses of 8" tall blocks.

## **ROCKWOOD**<sup>®</sup> RETAINING WALLS

*A better way.™*

*Note: For complete retaining wall installation instructions, request a copy of the manual for the block system you are building with.*

*Electronic versions are available online at: [www.rochesterpcp.com/install](http://www.rochesterpcp.com/install)*

## classic 6 & 8 walls - 20" pillar

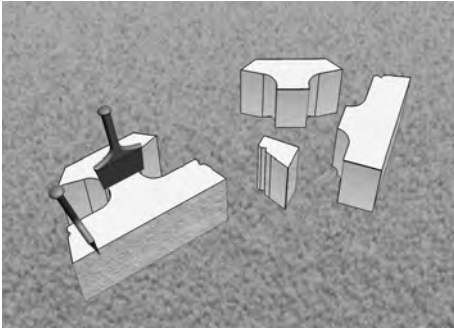

### Step 1 - Create a (Corner) Pillar Block

If you need to create corners on the job site, see instructions on previous page on how to create Corner Blocks.

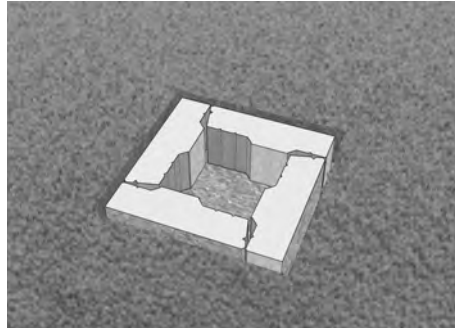

### Step 2 - Excavating and Site Preparation

Follow the steps for a leveling pad installation, as described in basic wall installation. Lay the first four pillar blocks with the split faces exposed to create the foundation for the 20" Pillar.

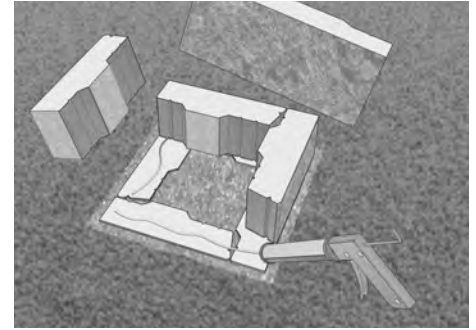

### Step 3 - Successive Course Installation

Stagger the pillar blocks so a running bond is maintained. Adhere all blocks with Super-Stik™.

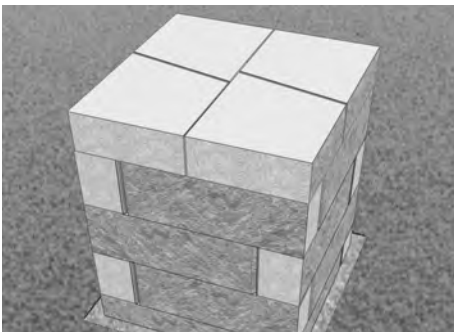

### Step 4 - Capping a 20" Pillar

A 20" Pillar may be capped with Universal Caps, stone, or other prefabricated products. Adhere caps with Super-Stik™.

## classic 6 & 8 walls - half-block pillar

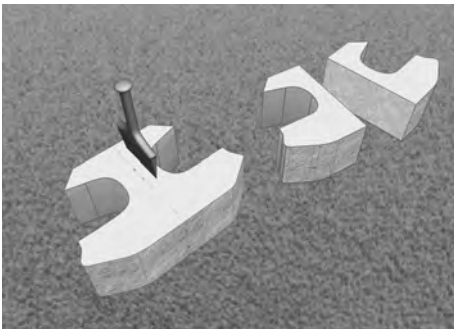

### Step 1 - Create a Half Block

If you need to create Half Blocks on the job site, be sure you have Base Block.

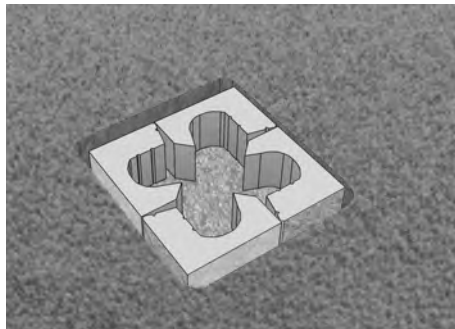

### Step 2 - Excavating and Site preparation

Follow the steps for a leveling pad installation, as described in basic wall installation. Lay the first four Half Blocks with the split faces exposed to create the foundation for the Half Block Pillar.

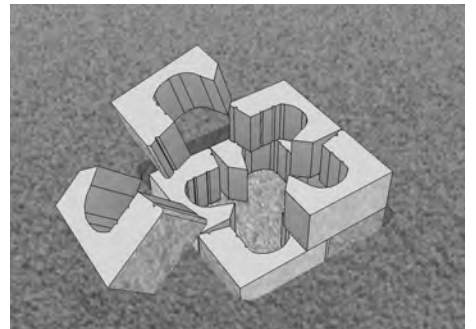

### Step 3 - Successive Course Installation

Stagger the Half Blocks so a running bond is maintained. Adhere all blocks with Super-Stik™.

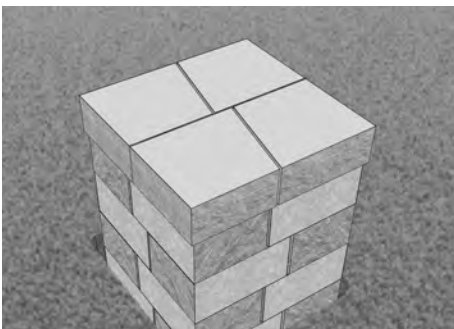

### Step 4 - Capping a Half Block Pillar

A Half Block Pillar may be capped with Universal Caps, stone or other prefabricated products. Adhere caps with Super-Stik™.

## classic 6 & 8 walls - 90° corners

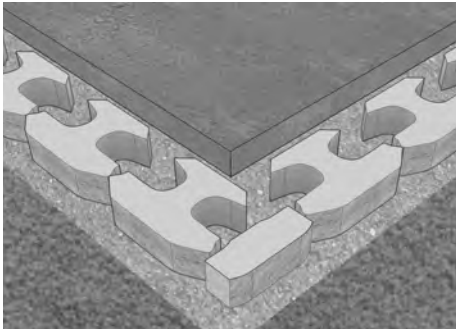

### Base Course Preparation with Corner Block

Begin an **outside corner** from the corner of the wall and install the blocks from the corner out when possible.

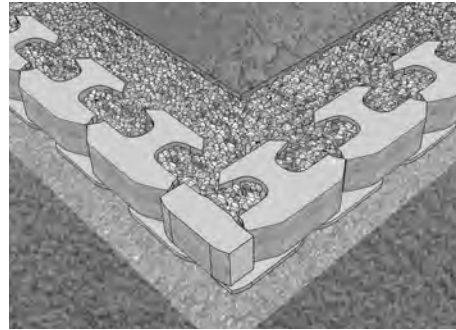

### Successive Course Installation

Stagger the Corner Block as each successive course is installed so it is on the opposite side of the wall corner. Length adjustments to the Corner Block may be necessary to maintain a running bond.

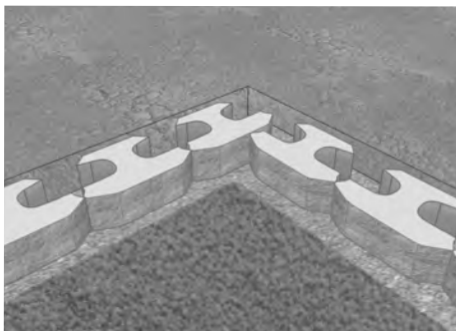

### Base Course Preparation

Begin an **inside corner** from the corner of the wall and install the blocks from the corner out when possible. Only half of a whole block installed on the corner will be exposed. This is true of each successive block that is staggered in the corner.

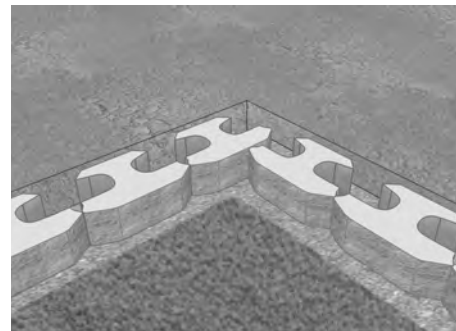

### Successive Course Installation

Gaps will develop in successive courses, which will require a "wedge" block to fill the gap. Measure the gap and cut a block to fill the gap. Adhere cut block with Super-Stik™. Depending on the height of the wall, the "wedge" block will eventually become the same size as a whole block, then the process repeats itself.

## classic 6 & 8 walls - adjusting setback for vertical walls

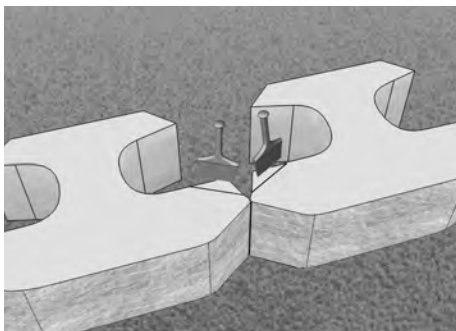

Rockwood's blocks offer the unique ability to modify the facing batter of a wall. This is especially useful in stair step and egress window applications. For 6" tall Blocks, adjust setback by 3/4". For 8" tall Blocks, adjust setback by 1". The setback is determined by how much material is removed.

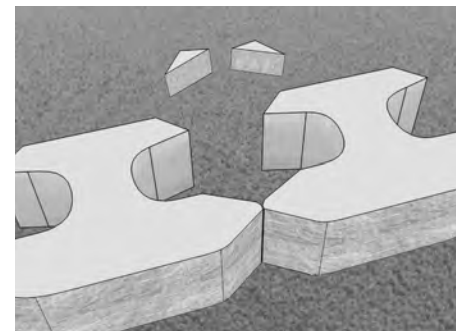

To adjust the setback, modify the two blocks below the successive course by splitting at the grooves on the top of each block.

**NEVER ALTER THE ANCHOR BAR!** Doing so will adversely affect the performance of the wall.

# vintage wall - basic installation

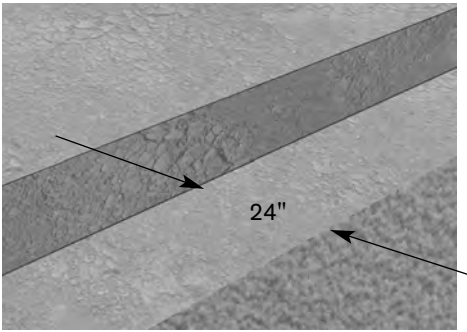

*Note: Vintage retaining walls may be built to a maximum total height of 40" without geogrid. Use a minimum 6" embedment and 12" of clean crushed rock behind wall.*

## Step 1 - Base Course Preparation

Beginning at the wall's lowest elevation, excavate a trench down the length of the wall with a minimum width of 24" to accommodate at least 6" of base material and 6" of block embedment. As a rule of thumb, for every 8" to 10" of wall height, 1" of block should be buried with a minimum of 6" base course embedment. Step the trench up or down with respect to adjacent grade.

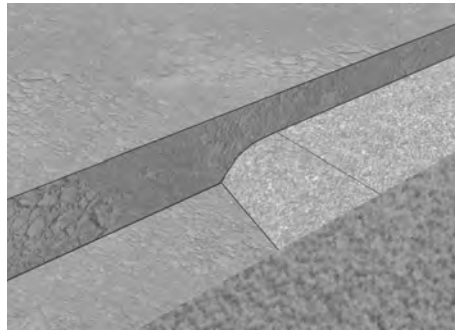

## Step 2 - Leveling Pad Installation

*Note: Unlike other wall systems, Vintage builds vertically with no setback. For this reason, take extra caution to make sure the first course is level from front to back to prevent tipping or overturning.*

When building under 3' in height, place and compact a minimum of 6" base material to 95% Standard Proctor. Verify the base is level with a transit or hand level. Be aware the base material (commonly referred to as road base or base aggregate) will vary from region to region.

When building over 3' in height, it is highly recommended to build on a 7.1° inclined base (a 1" setback). Simply place 3" of material on top of your compacted leveling pad. Screed the excess material away using a level tied to an angled board, compact to 95% std. proctor. Walls 4' and above need to be built with geosynthetic reinforcement and may need to be designed by a licensed engineer.

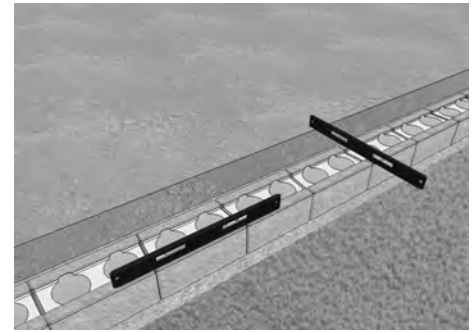
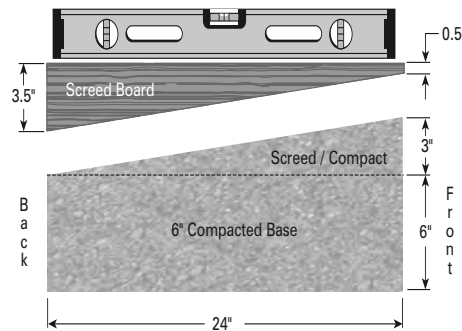

## Step 3 - Base Course Installation

The base course will consist of Vintage 8" x 18" blocks. Use a string line for alignment on straight wall applications. All blocks should rest firmly on the pad and be centered on the base to allow approximately 6" of base area in front and behind the block. Level each block side-to-side, front-to-back, and across three full blocks with a hand level. A rubber mallet may be used to level and align the Vintage blocks.

*Note: For best alignment results on straight walls use the string line within the interlocking channel.*

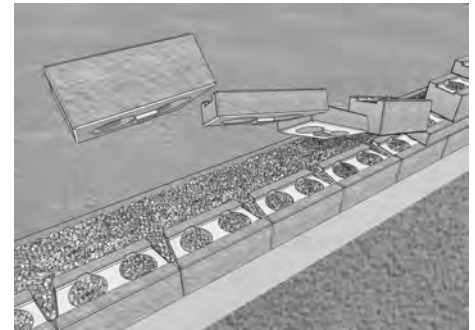

## Step 4 - Core and Drainage Fill

Place 3/4" to 1" clean aggregate (crushed rock) a minimum of 12" behind the blocks. This creates a drainage zone that helps to unify and maximize the performance of the wall. Fill all Vintage cores with the same 3/4" to 1" clean aggregate to create vertical Stone Columns. Stone Columns unify the block and grid connection to further strengthen the wall.

**ROCKWOOD**<sup>®</sup>  
RETAINING WALLS  
*A better way.*<sup>™</sup>

*Note: For complete retaining wall installation instructions, request a copy of the manual for the block system you are building with.*

*Electronic versions are available online at: [www.rochesterpc.com/install](http://www.rochesterpc.com/install)*

# vintage wall - 90° corners

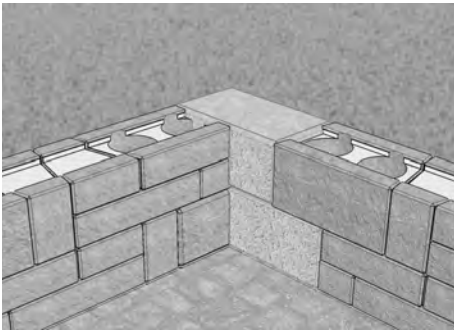

16" Freestanding Wall Pattern

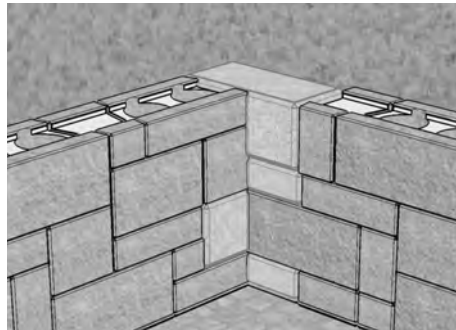

24" Freestanding Wall Pattern

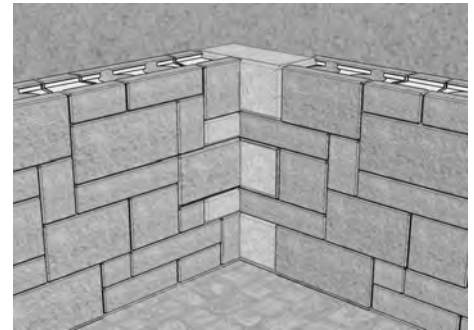

32" Freestanding Wall Pattern

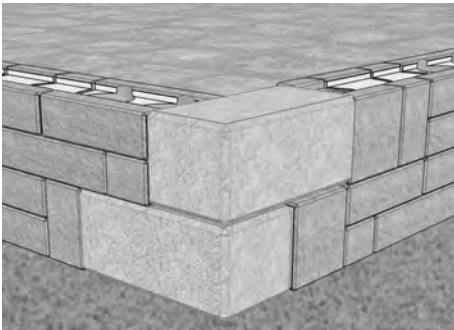

16" Retaining Wall Pattern

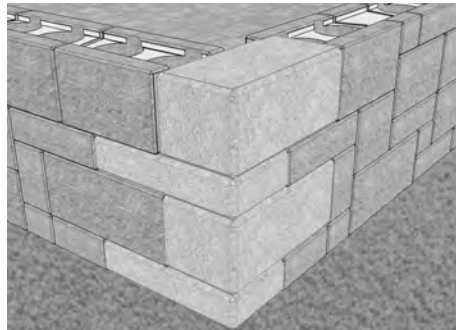

24" Retaining Wall Pattern

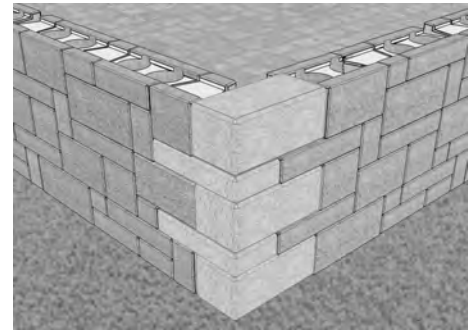

32" Retaining Wall Pattern

Stagger the End Blocks as each successive course is installed so it is on the opposite side of the wall corner. A combination of 4" and 8" End Blocks will be used for the corner wall installation. *Note: Cutting may be required for inside and outside corner blocks.*

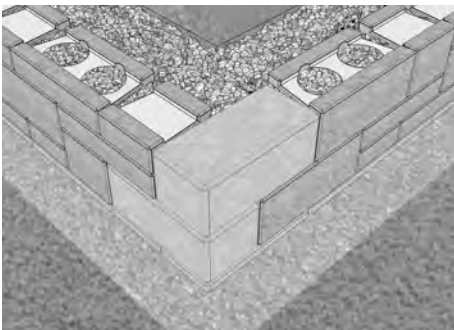

Begin an outside corner by installing the blocks from the corner out, when possible. Stagger the Corner Blocks as each successive course is installed. Depending on the wall pattern, a combination of 4" and 8" Corner Blocks will be used for the corner wall installation.

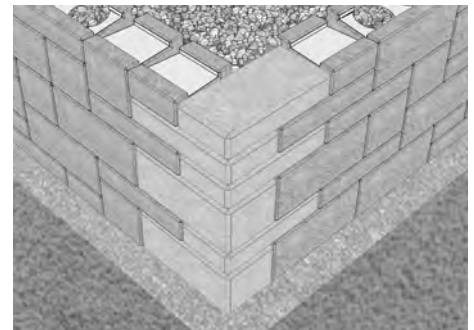
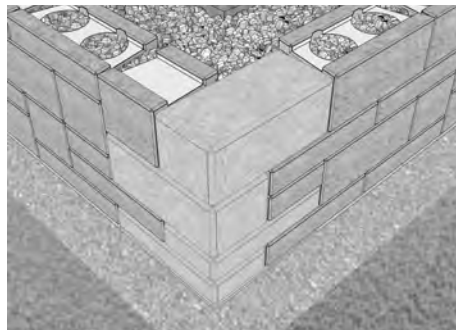

32" Retaining Wall Pattern

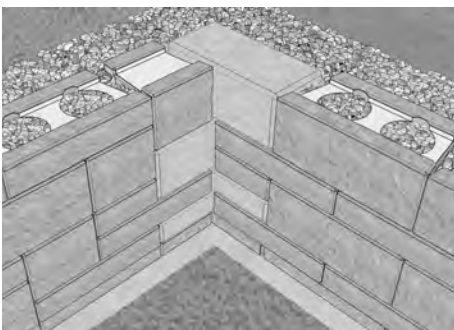

Begin an **inside corner** from the corner of the wall and install the blocks from the corner out, when possible. If you have to build the wall from the outside to the corner, it may be necessary to cut blocks to secure a proper fit.



# vintage wall - freestanding pillar

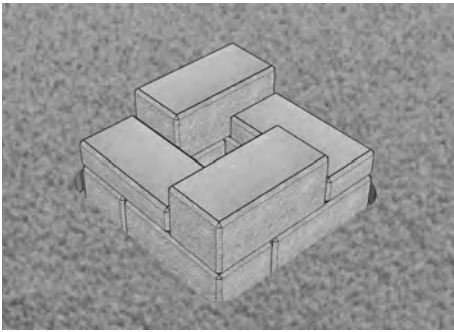

### Starting a Pillar

Follow the steps for a leveling pad installation, as described in basic wall installation.

Using 8" Pillar Blocks, bury the first course to establish the foundation for your Vintage pillar. Design pillars in 12" lifts above the base course.

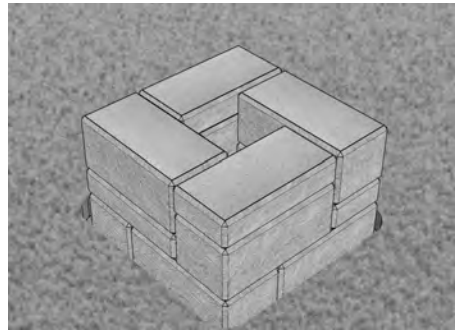

### Add More Courses

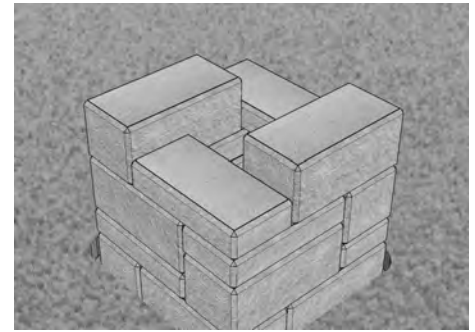

### Add More Courses

Each pillar course is built in 12" increments, consisting of 4" and 8" tall Vintage Pillar Blocks. Use adhesive on each block as you build.

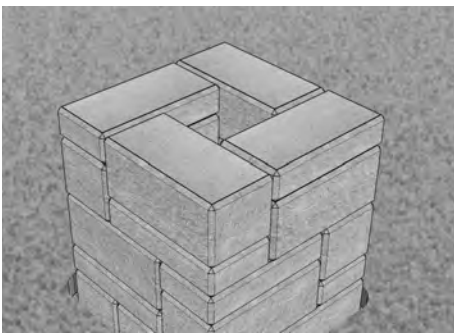

### Add More Courses

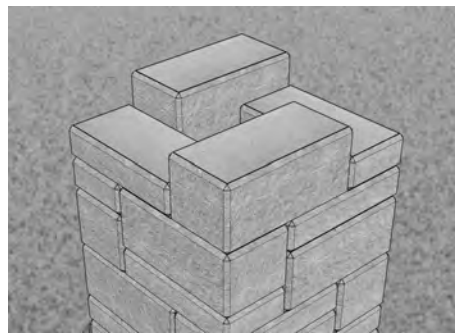

### Add More Courses

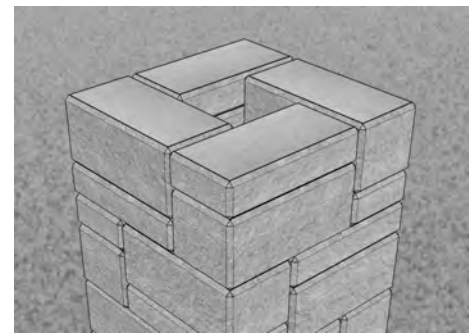

### Step 7 - Finishing

Add Pillar Blocks so the last course creates a flush surface as shown. To finish the pillar, adhere your desired cap material securely in place using Super-Stik adhesive.



**Rochester**  
Concrete Products™



Cheeca Lodge Islamorada, Florida Keys  
November 28 - December 1, 2017

For complete details visit: [www.rochesterpc.com/trip](http://www.rochesterpc.com/trip)

The 2017 Hardscapes Passport to Paradise is sponsored by:

**ROCKWOOD**<sup>®</sup>  
RETAINING WALLS  
*A better way.*<sup>™</sup>



[www.cheeca.com](http://www.cheeca.com)



## The Hardscapes Passport to Paradise, is the ultimate rewards trip.

- Four days & three nights (Nov. 28 thru Dec. 1st) in the lavish Cheeca Lodge & Spa on the island of Islamorada—right in the heart of the breathtaking Florida Keys. Airfare & round-trip transfers included in each trip.
- Meet & Greet beside the tranquil turquoise waters of the Tropical Spa Lagoon, complete with island music and tropical drinks.
- Enjoy elegant and scrumptious island cuisine at various Rockwood hosted dining events.
- Visit the Rockwood Expo featuring many cutting-edge leaders in our industry.
- Informative Meetings & Educational Workshops – with a twist! Network with industry leaders and grow your business.
- Fishing off of Bud-n-Mary's 65 foot boat, the Miss Islamorada.

- Play tennis or golf, float in one of two pools, fish off the end of the 525 foot private pier, or simply relax on the beach, the choice is yours.
- Experience "Barefoot Elegance" on the private white sandy beach at the Rockwood Recognition Gala.

## Once you arrive at the Cheeca Lodge & Spa – you may never want to leave.

- Cheeca Lodge & Spa is situated on a 27-acre enclave with lush tropical landscaping offering secluded relaxation.
- Lounge on one of the longest and most beautiful private beaches in Florida, offering relaxation enthusiasts a paradise of recreational opportunities.
- Atlantic's Edge Restaurant, Limoncello, Nikai Sushi Bar and The Tiki Bar – each catering to different tastes and budgets. Indulge in island-inspired cocktails, award-winning dining – renowned for fresh, tropical-inspired cuisine featuring wild, exotic and naturally farmed meats and fish fused with a unique Florida twist.

- The Spa at Cheeca Lodge offers gentle indulgences beneath the swaying palms of the Florida Keys.
- Cheeca Lodge and Spa offers kayaking, parasailing, stand-up paddle boards, bicycles and fishing rods at no charge.
- Take in the laid-back atmosphere of this little island - from glorious sunrises to magnificent sunsets, the days are filled with endless pursuits of pleasure.

- Shoppers will enjoy the many area boutiques and galleries filled with one-of-a-kind gifts, apparel and art.
- Local transportation within two miles of Cheeca is provided at no charge.

## Earn your rewards!

For complete details, visit us online at: [www.rochesterpc.com/trip](http://www.rochesterpc.com/trip)

The Passport to Paradise rewards program offering is subject to change.

- Islamorada - between the saltwater wilderness of Everglades and North America's only coral barrier reef to the deep blue waters of the Florida Straits. Islamorada might be the only place on Earth where you might catch a sailfish in the morning, and then venture into the backcountry in pursuit of bonefish, permit, tarpon, snook and redfish in just inches of water. This "Sports Fishing Capital of the World" is where you'll find fishing poles right in your room.
- Snorkel the coral reefs and deep-sea fishing in crystal blue waters.
- A trip to Islamorada would not be complete without sampling some of the local island cuisine headlined by succulent fresh seafood served everywhere from island tiki bars and dockside fish houses to gourmet beachfront cafes and secluded island bistros.





welcome to the backyard...



you're going to love it out here!™



**Corporate Office:**  
7200 Broadway Ave N  
Rochester, MN 55906  
Phone: 507-288-8850  
Fax: 507-288-3810

W6558 Hwy 33  
Juneau, WI 53039  
Phone: 920-386-3333

N14665 Dickerson Ave.  
Thorp, WI 54771  
Phone: 715-669-5552

3535 Bluff Drive  
Jordan, MN 55352  
Phone: 952-492-3636

[www.rochesterpcp.com](http://www.rochesterpcp.com)

© Copyright 2017. All Rights Reserved. All trademarks and registered trademarks are the property of their respective owners. Rockwood Retaining Walls products are made worldwide under license from Rockwood Retaining Walls, Inc. US and international patents issued and pending. The information presented here has been prepared for the benefit of customers interested in Rochester Concrete Products, it was reviewed carefully prior to publication. Rochester Concrete Products assumes no liability for its accuracy or completeness. Final determination of the suitability of any information or material for the use contemplated, or for its manner of use, is the sole responsibility of the user. PROPOSITION 65 WARNING: These Products, the fuel used in this Products and other wood and charcoal burning appliances, and the combustion products of such fuels contain chemicals known to the State of California to cause cancer, or birth defects or other reproductive harm.217

