

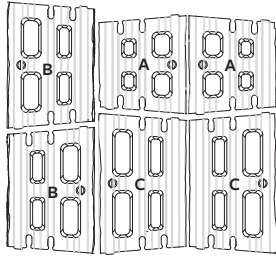

BRANDON 90 mm

DESCRIPTION: Double-sided wall TEXTURE: Slate

PALLET OVERVIEW



COMPATIBLE CAPS

See page 140 for product compatibility.

NOTES

When building a double-sided wall one pallet will cover an average of 19.28 ft².

See page 135 to 156 for more technical information.

Specifications per pallet	Imperial	Metric
Cubing	20.44 ft²	1.90 m ²
	69.23 lin. ft	21.10 lin. m
Approx. Weight	1 684 lbs	764 kg
Minimum radius	7.5 ft	2.3 m
Number of rows	10	
Coverage per row	2.04 ft ²	0.19 m ²
Linear coverage per row	6.92 lin. ft	2.11 lin. m



Unit dimensions	in	mm	Units/pallet
Height	3 ⁹ / ₁₆	90	20 units
Depth	9 ¹³ / ₁₆	250	
Length 1	11 ¹ / ₄	285	
Length 2	9 ⁵ / ₈	245	

B



Height	3 ⁹ / ₁₆	90	20 units
Depth	9 ¹³ / ₁₆	250	
Length 1	14 ³ / ₈	365	
Length 2	12 ¹³ / ₁₆	325	

C



Height	3 ⁹ / ₁₆	90	20 units
Depth	9 ¹³ / ₁₆	250	
Length 1	15 ¹⁵ / ₁₆	405	
Length 2	14 ³ / ₈	365	

Chestnut Brown



Sandlewood



Champlain Grey



Shale Grey



Onyx Black

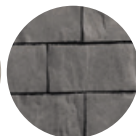



BRANDON 180 mm

DESCRIPTION: Double-sided wall **TEXTURE:** Slate

PALLET OVERVIEW

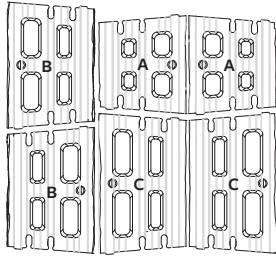

COMPATIBLE CAPS

See page 140 for product compatibility.

NOTES

When building a double-sided wall one pallet will cover an average of 19.28 ft².

See page 135 to 156 for more technical information.

Specifications per pallet	Imperial	Metric
Cubing	20.44 ft²	1.90 m ²
	34.61 lin. ft	10.55 lin. m
Approx. Weight	1 719 lbs	780 kg
Minimum radius	7.5 ft	2.3 m
Number of rows	5	
Coverage per row	4.09 ft ²	0.38 m ²
Linear coverage per row	6.92 lin. ft	2.11 lin. m



Unit dimensions	in	mm	Units/pallet
Height	7 ¹ / ₁₆	180	10 units
Depth	9 ¹³ / ₁₆	250	
Length 1	11 ¹ / ₄	285	
Length 2	9 ⁵ / ₈	245	

B



Height	7 ¹ / ₁₆	180	10 units
Depth	9 ¹³ / ₁₆	250	
Length 1	14 ³ / ₈	365	
Length 2	12 ¹³ / ₁₆	325	

C



Height	7 ¹ / ₁₆	180	10 units
Depth	9 ¹³ / ₁₆	250	
Length 1	15 ¹⁵ / ₁₆	405	
Length 2	14 ³ / ₈	365	

Chestnut Brown



Sandlewood



Champlain Grey

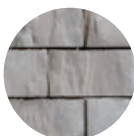

Shale Grey

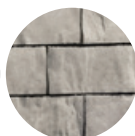

Onyx Black

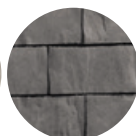



BRANDON 90 & 180 mm

DESCRIPTION: Pillars TEXTURE: Slate

PILLAR PALLET OVERVIEW

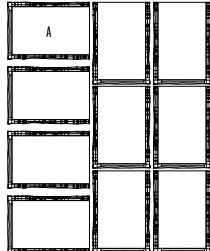



COMPATIBLE CAPS

See page 140 for product compatibility.



NOTES

See page 135 to 156 for more technical information.

Specifications per pallet		Imperial	Metric
PILLAR 90 mm	Cubing	40 units	40 units
	Approx. Weight	1 625 lbs	737 kg
	Number of rows	4	
	Pillar height	35 $\frac{7}{16}$	900 mm

 	Unit dimensions		in	mm	Units/pallet
	Height	3 $\frac{7}{16}$	90	40 units	
	Depth	9 $\frac{13}{16}$	250		
	Length	14 $\frac{3}{16}$	360		

Specifications per pallet		Imperial	Metric
PILLAR 180 mm	Cubing	20 units	20 units
	Approx. Weight	1 636 lbs	742 kg
	Number of rows	2	
	Pillar height	35 $\frac{7}{16}$	900 mm

 	Unit dimensions		in	mm	Units/pallet
	Height	7 $\frac{1}{16}$	180	20 units	
	Depth	9 $\frac{13}{16}$	250		
	Length	14 $\frac{3}{16}$	360		

Chestnut Brown

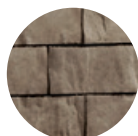

Sandlewood



Champlain Grey



Shale Grey



Onyx Black

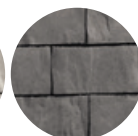

CLEAN SAND/GRAVEL/ SAND AND GRAVEL MIXES ($\phi=34^\circ$, $\gamma = 120$ pcf)
GEOGRID: MIRAGRID 3XT BY TENCATE (RFd=1.10, RFcr=1.45, RFid=1.25, Cds=0.9, Ci=0.9)

CASE N° 1 :
No Surcharge
No Backslope
No Toe Slope

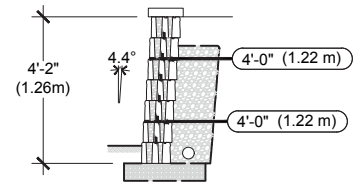
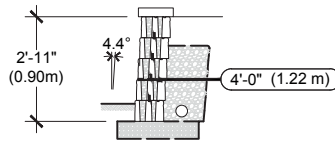
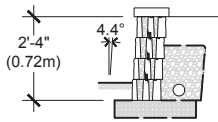

VISIT WWW.TECHO-BLOC.COM FOR COMPLETE DESIGN CHART DOCUMENT
(USA AND CANADA VERSIONS)

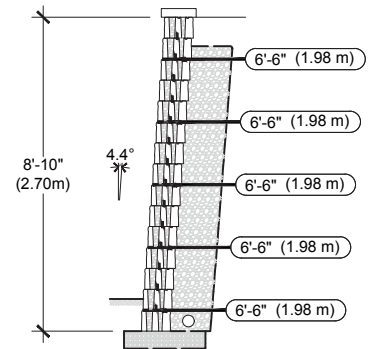
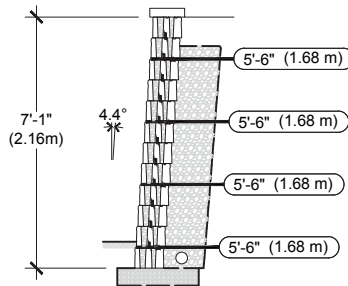
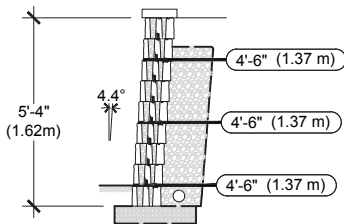

WALLS & PILARS

- The information contained in the design charts is supplied for information purposes only and as such should only be used for preliminary designs.
- The height (H) of the wall is the total height from the leveling pad to the top of the wall not including the thickness of the cap.
- Soil parameters: reinforced soil ($\phi = 34^\circ$, $\gamma = 120$ pcf); retained soil ($\phi = 34^\circ$, $\gamma = 120$ pcf); foundation soil ($\phi = 34^\circ$, $\gamma = 120$ pcf)
- A qualified engineer should be consulted for the final design to be used for construction.
- The foundation soil must be able to support the wall system. The bearing capacity of the foundation soil, settlement, and global stability must be verified and validated by a qualified geotechnical engineer.
- The seismic analysis is not included.
- The design charts do not apply to tiered walls.
- The charts assume that the walls are constructed in accordance with Techo-Bloc specifications, good construction practice and an adequate drainage system.
- The geogrid layout has been optimized to satisfy the design requirements of the NCMA's Design Manual for Segmental Retaining Walls, 3rd Edition.
- The minimum burial depth must be 6 in (150 mm) or 10% of the exposed height, whichever is greater.
- Engineering judgement should be used when interpolating between heights.
- Techo-Bloc and its predecessors, successors, beneficiaries, employees, associates, administrators and insurers accepts no liability for the incorrect use of information contained in the design charts.
- For further information, please contact our technical service department.

techo-bloc.com

INSTALLATION GUIDE

RETAINING WALLS - BRANDON 90 & 180 mm

1-Row Pattern | Laying Patterns

The 1-row pattern provides three different combinations. Each combination is 10.38' (3.165 m) long and 7 1/16" (180 mm) high. **This pattern can be used for installing the last row of modules or where other patterns cannot be used.**

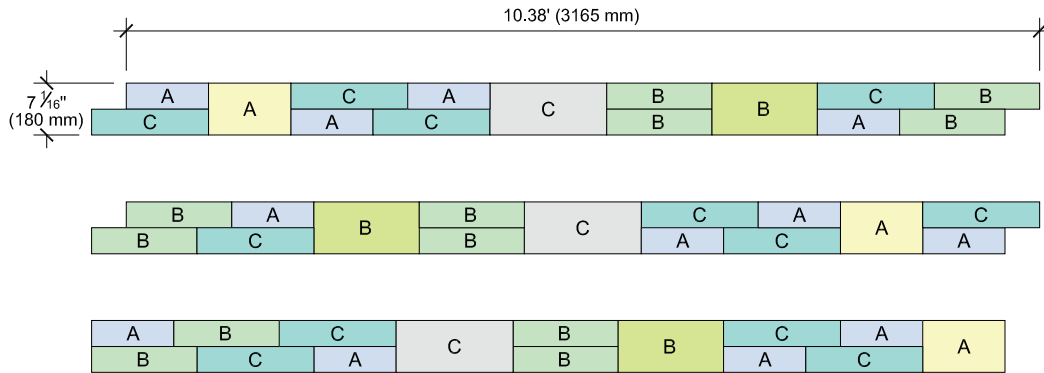

NUMBER OF BLOCKS REQUIRED

MODULE

BRANDON

67% of the surface - Brandon 90 mm

A

B

C

33% of the surface - Brandon 180 mm

1

1

1

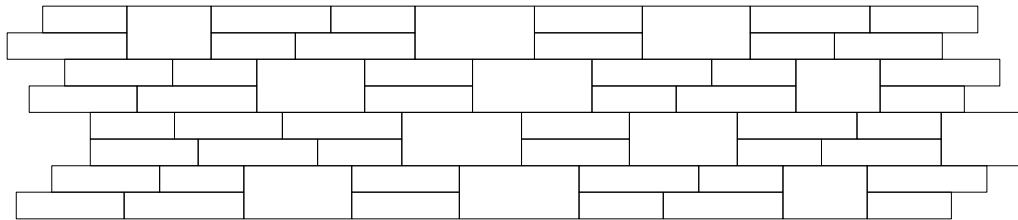

INSTALLATION GUIDE

RETAINING WALLS - BRANDON 90 & 180 mm

3-Row Pattern | Laying Patterns

The 3-row pattern is 10.38' (3.165 m) long and 21 ¼" (540 mm) high. This pattern allows a continuous leveled surface every 21 ¼" (540 mm), which corresponds to the recommended maximum spacing between the layers of geogrid in a Brandon wall. **This pattern is recommended when using the geogrid.**

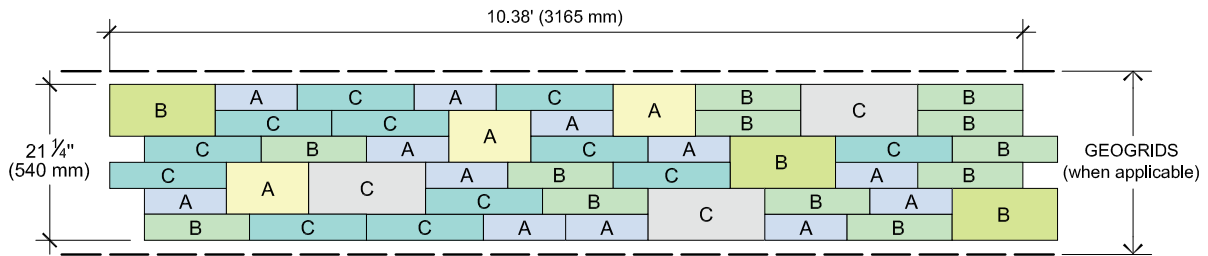

NUMBER OF BLOCKS REQUIRED

MODULE

BRANDON

67% of the surface - Brandon 90 mm

33% of the surface - Brandon 180 mm

A

B

C

12

12

12

3

3

3

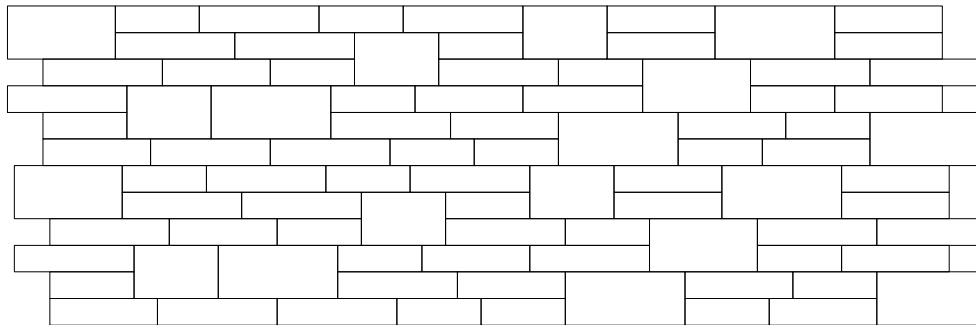

INSTALLATION GUIDE

RETAINING WALLS - BRANDON 90 & 180 mm

4-Row Pattern | Laying Patterns

The 4-row pattern is 10.38' (3.165 m) long and 28 3/8" (720 mm) high. **This pattern should be used only where the geogrid is not required.**

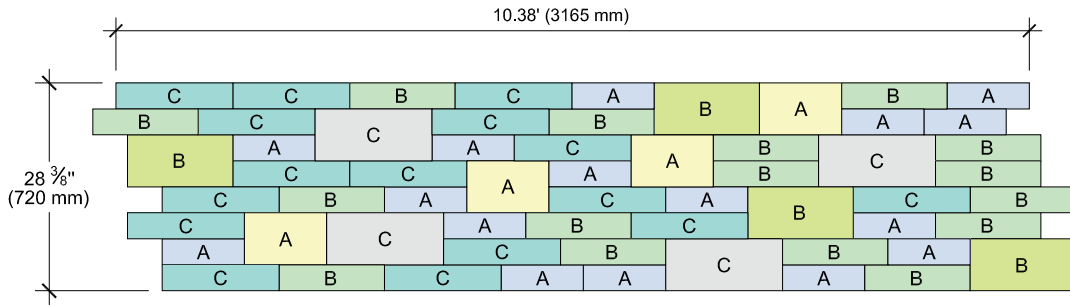

NUMBER OF BLOCKS REQUIRED

MODULE

BRANDON

67% of the surface - Brandon 90 mm

33% of the surface - Brandon 180 mm

	A	B	C
67% of the surface - Brandon 90 mm	16	16	16
33% of the surface - Brandon 180 mm	4	4	4

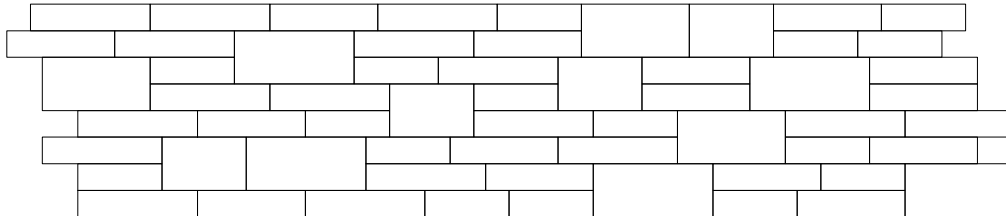

INSTALLATION GUIDE

FREESTANDING WALLS - BRANDON 90 & 180 mm

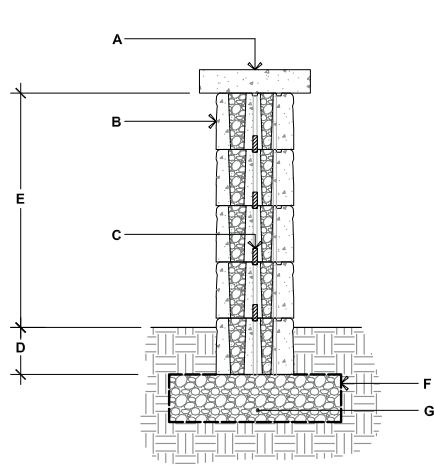

BRANDON 90 mm & 180 mm

- A.** TECO-BLOC CAP UNIT SECURED TO UNIT BELOW WITH FLEXLOCK ADHESIVE
- B.** BRANDON 90 mm AND 180 mm DOUBLE-SIDED WALL UNITS SECURE EACH ROW WITH FLEXLOCK ADHESIVE
- C.** CONNECTOR
- D.** EMBEDMENT DEPTH, 6" (150 mm) MIN.
- E.** 29 7/16" (750 mm) MAX.
- F.** GEOTEXTILE
- G.** COMPACTED GRANULAR LEVELING PAD, 6" (150 mm) THICK MIN. THICKNESS ACCORDING TO PROJECT SPECIFIC CONDITIONS

90° CORNER OF A DOUBLE-SIDED WALL

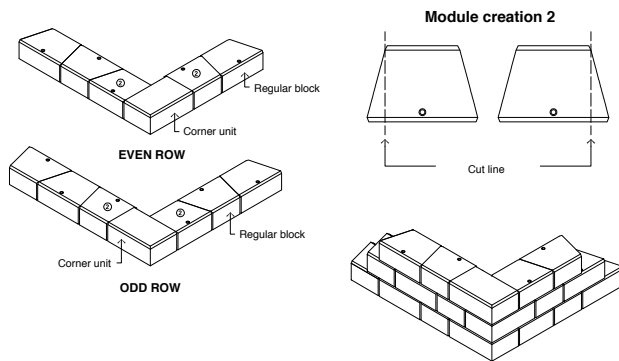

1. Alternate odd and even rows.
2. Stagger joints from one row to the next.
3. Glue all modules at each row with Flexlock adhesive.
4. Cavities, grooves and connectors are not illustrated to avoid overloading the image.

DOUBLE-SIDED WALL - END OF A STRAIGHT WALL

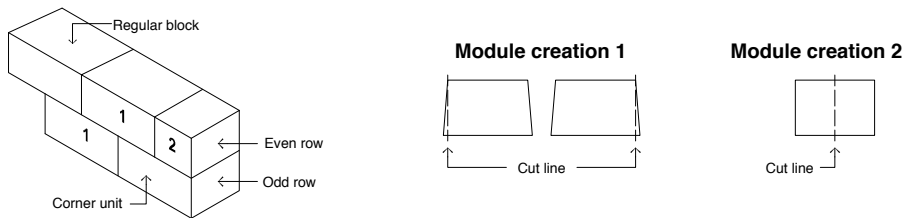

GENERAL NOTES

1. Alternate odd and even rows.
2. Stagger joints from one row to the next.
3. Glue all modules at each row with Flexlock adhesive.
4. Cavities, grooves and connectors are not illustrated to avoid overloading the image.

PLEASE REFER TO P.4 FOR THE CORRECT USE AND LIMITATIONS OF PROVIDED TECHNICAL INFORMATION.

INSTALLATION GUIDE

DOUBLE-SIDED WALL RADIUS - BRANDON 90 & 180 mm

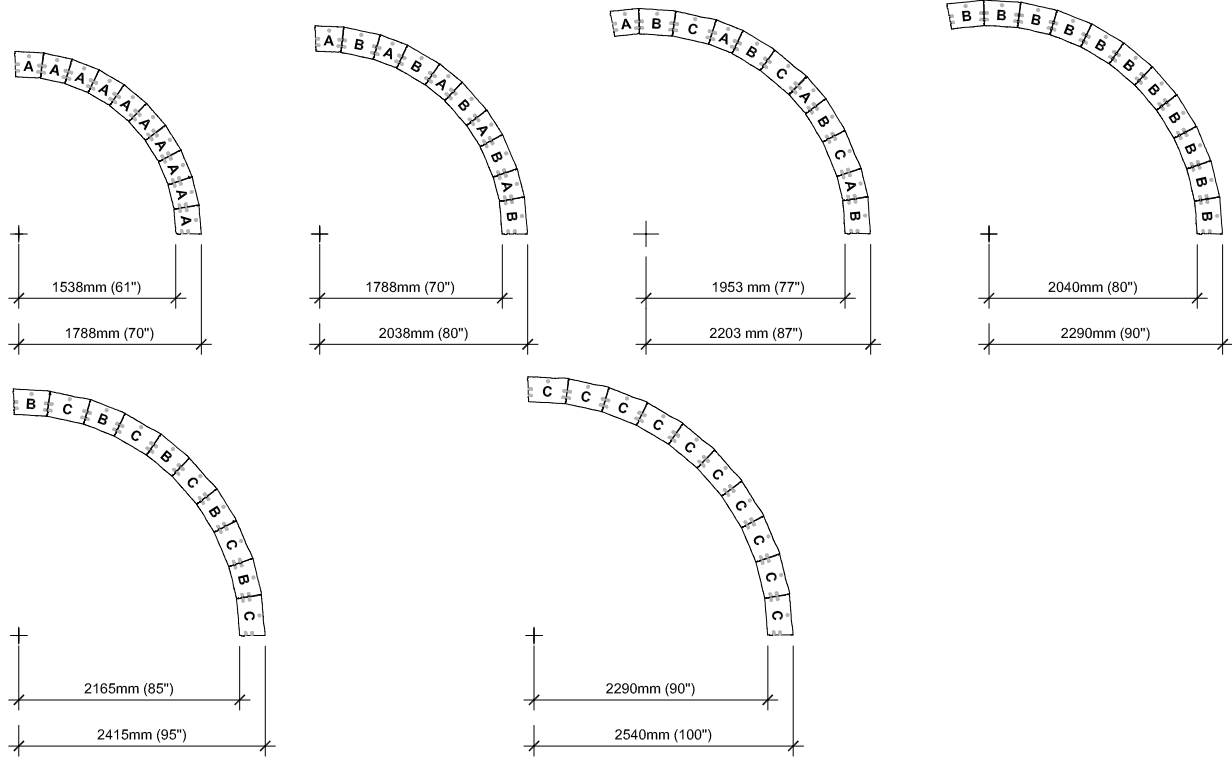

It is the user's responsibility to verify for the quantity of materials required.

STEPS

BRANDON 90 mm

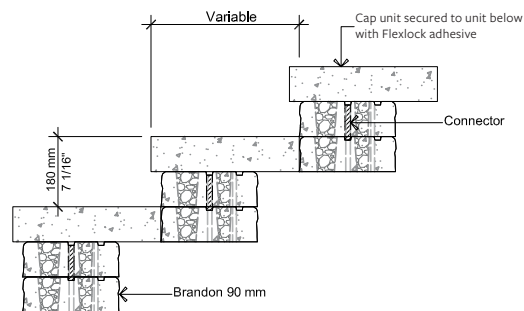

BRANDON 180 mm

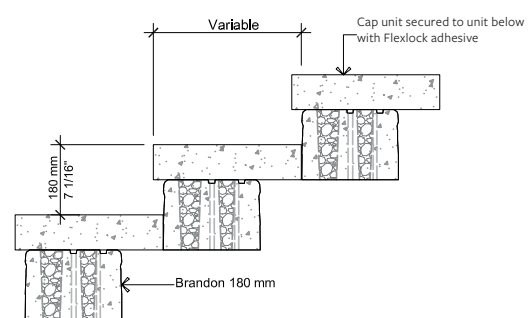

For all possible combinations of pillars and caps, please refer to the correspondence table on page 140

INSTALLATION GUIDE

PILLARS - BRANDON 90 & 180 mm

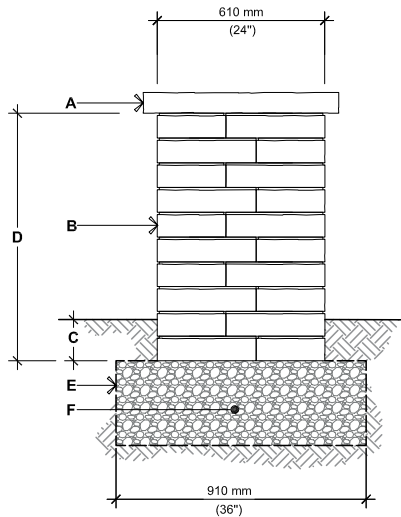

BRANDON 90 mm

- A.** PILLAR CAP UNIT, SECURE TO UNITS BELOW WITH FLEXLOCK ADHESIVE
- B.** BRANDON 90 mm PILLAR UNIT SECURE EACH ROW WITH FLEXLOCK ADHESIVE
- C.** EMBEDMENT DEPTH: 150 mm (6") MIN.
- D.** 900 mm (35 7/16"), HEIGHT PER PALLET 1 080 mm (42 1/2"), MAXIMUM HEIGHT
- E.** GEOTEXTILE
- F.** COMPACTED GRANULAR BASE 150 mm (6") THICK MIN. THICKNESS ACCORDING TO PROJECT SPECIFIC CONDITIONS

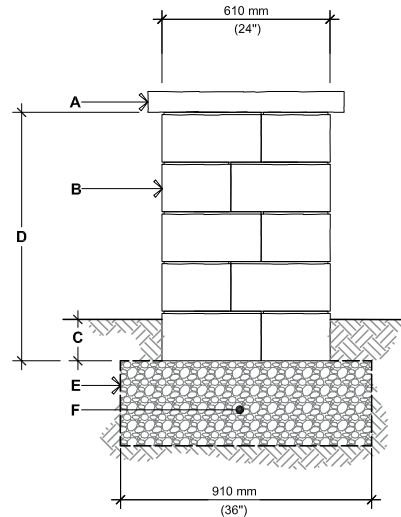

BRANDON 180 mm

- A.** PILLAR CAP UNIT, SECURE TO UNITS BELOW WITH FLEXLOCK ADHESIVE
- B.** BRANDON 180 mm PILLAR UNIT SECURE EACH ROW WITH FLEXLOCK ADHESIVE
- C.** EMBEDMENT DEPTH: 150 mm (6") MIN.
- D.** 900 mm (35 7/16"), HEIGHT PER PALLET 1 080 mm (42 1/2"), MAXIMUM HEIGHT
- E.** GEOTEXTILE
- F.** COMPACTED GRANULAR BASE 150 mm (6") THICK MIN. THICKNESS ACCORDING TO PROJECT SPECIFIC CONDITIONS

For all possible combinations of pillars and caps, please refer to the correspondence table on page 140

INSTALLATION GUIDE

PILLARS - BRANDON 90 & 180 mm

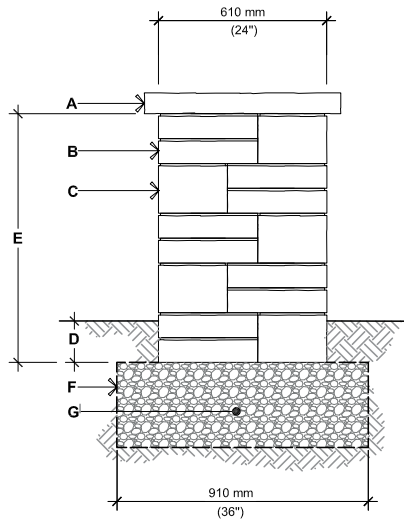

BRANDON 90 mm & 180 mm
OPTION A

- A.** PILLAR CAP UNIT, SECURE TO UNITS BELOW WITH FLEXLOCK ADHESIVE
- B.** BRANDON 90 mm PILLAR UNIT
SECURE EACH ROW WITH FLEXLOCK ADHESIVE
- C.** BRANDON 180 mm PILLAR UNIT
SECURE EACH ROW WITH FLEXLOCK ADHESIVE
- D.** EMBEDMENT DEPTH: 150 mm (6") MIN.
- E.** 900 mm (35 7/16"),
1 080 mm (42 1/2"), MAXIMUM HEIGHT
- F.** GEOTEXTILE
- G.** COMPACTED GRANULAR BASE 150 mm (6")
THICK MIN. THICKNESS ACCORDING TO
PROJECT SPECIFIC CONDITIONS

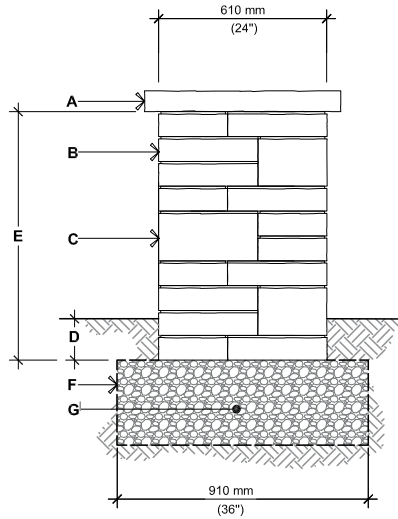

BRANDON 90 mm & 180 mm
OPTION B

- A.** PILLAR CAP UNIT, SECURE TO UNITS BELOW WITH FLEXLOCK ADHESIVE
- B.** BRANDON 90 mm PILLAR UNIT
SECURE EACH ROW WITH FLEXLOCK ADHESIVE
- C.** BRANDON 180 mm PILLAR UNIT
SECURE EACH ROW WITH FLEXLOCK ADHESIVE
- D.** EMBEDMENT DEPTH: 150 mm (6") MIN.
- E.** 900 mm (35 7/16"),
1 080 mm (42 1/2"), MAXIMUM HEIGHT
- F.** GEOTEXTILE
- G.** COMPACTED GRANULAR BASE 150 mm (6")
THICK MIN. THICKNESS ACCORDING TO
PROJECT SPECIFIC CONDITIONS

For all possible combinations of pillars and caps, please refer to the correspondence table on page 140

INSTALLATION GUIDE

GRILL ISLAND - BRANDON 90 & 180 mm

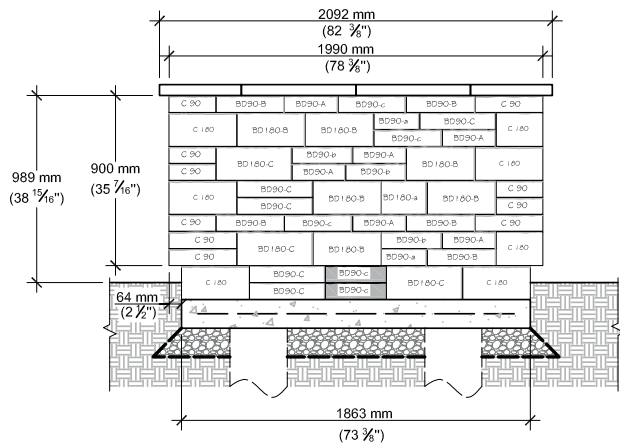

ELEVATION A

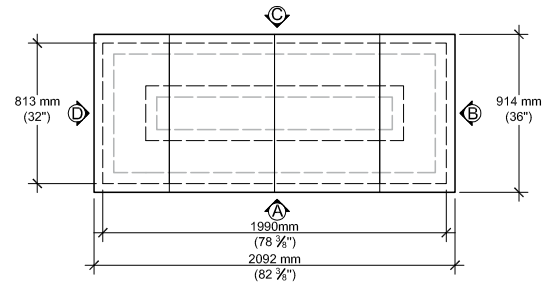

TOP VIEW

- A. YORK COUNTER TOP 24" × 36" × 2 1/4"
- B. BRANDON 90 mm UNIT (A, B OR C) - LONG FACE EXPOSED (SHOWN WITH UPPERCASE LETTER)
- C. BRANDON 90 mm UNIT (A, B OR C) - SHORT FACE EXPOSED (SHOWN WITH LOWERCASE LETTER)
- D. BRANDON 180 mm UNIT (A, B OR C) - LONG FACE EXPOSED (SHOWN WITH UPPERCASE LETTER)
- E. BRANDON 180 mm UNIT (A, B OR C) - SHORT FACE EXPOSED (SHOWN WITH LOWERCASE LETTER)
- F. BRANDON 90 mm PILLAR UNIT
- G. BRANDON 180 mm PILLAR UNIT
- H. BRANDON UNIT CUT ON FIELD
- I. CAST IN PLACE CONCRETE SLAB 4350 psi (30 MPa), 5" (125 mm) THICK
- J. 4X4-4/4 (102X102-MW25.8XMW25.8) WELDED WIRE MESH AND/OR REBAR AS PER SITE CONDITIONS
- K. 12" (300 mm) DIA. CONCRETE PILLAR, AS PER LOCAL CODE
- L. 3/4" (20 mm) CLEAN STONE 6" (150 mm) THICK MIN. AS PER SITE CONDITIONS
- M. NATURAL SOIL OR COMPACTED BACKFILL
- N. GEOTEXTILE

QUANTITY OF MATERIALS REQUIRED

- York Counter top 24" × 36" × 2 1/4": **4**
- Brandon 90 mm unit: **20** A, **20** B, **18** C
- Brandon 180 mm unit: **10** A, **10** B, **9** C
- Brandon 90 mm Pillar unit: **18**
- Brandon 180 mm Pillar unit: **15**

NOTE: Appliances and utilities may vary for each project and are not shown on this drawing. This drawing is shown for inspiration only and surplus or shortage of materials may result. It is the user's responsibility to verify for the quantity of materials required. Secure the blocks using a heat resistant concrete adhesive. The installer must ensure that the installation and use of the grill island comply with local regulations and code requirements. Concrete pillars extending to frost line may be required as per local code. Check your local building code before installing.

INSTALLATION GUIDE

GRILL ISLAND - BRANDON 90 & 180 mm - Cont'd

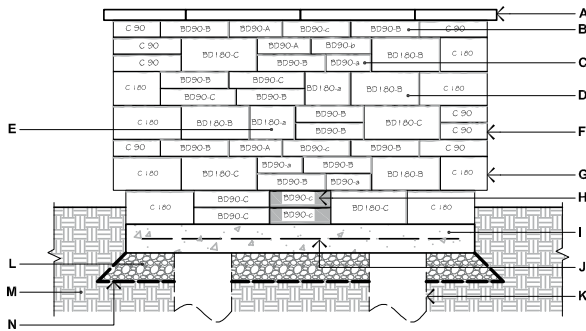

ELEVATION C

- A.** YORK COUNTER TOP 24" × 36" × 2 1/4"
- B.** BRANDON 90 mm UNIT (A, B OR C) - LONG FACE EXPOSED (SHOWN WITH UPPERCASE LETTER)
- C.** BRANDON 90 mm UNIT (A, B OR C) - SHORT FACE EXPOSED (SHOWN WITH LOWERCASE LETTER)
- D.** BRANDON 180 mm UNIT (A, B OR C) - LONG FACE EXPOSED (SHOWN WITH UPPERCASE LETTER)
- E.** BRANDON 180 mm UNIT (A, B OR C) - SHORT FACE EXPOSED (SHOWN WITH LOWERCASE LETTER)
- F.** BRANDON 90 mm PILLAR UNIT
- G.** BRANDON 180 mm PILLAR UNIT
- H.** BRANDON UNIT CUT ON FIELD
- I.** CAST IN PLACE CONCRETE SLAB 4350 psi (30 MPa), 5" (125 mm) THICK
- J.** 4X4-4/4 (102X102-MW25.8XMW25.8) WELDED WIRE MESH AND/OR REBAR AS PER SITE CONDITIONS
- K.** 12" (300 mm) DIA. CONCRETE PILLAR, AS PER LOCAL CODE
- L.** 3/4" (20 mm) CLEAN STONE 6" (150 mm) THICK MIN. AS PER SITE CONDITIONS
- M.** NATURAL SOIL OR COMPACTED BACKFILL
- N.** GEOTEXTILE

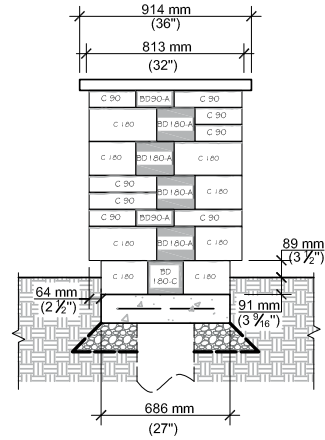

ELEVATION B

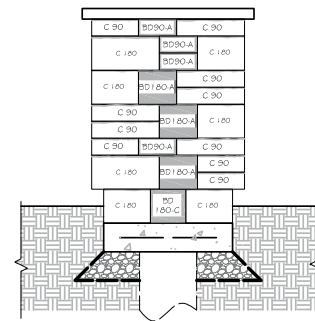

ELEVATION D

QUANTITY OF MATERIALS REQUIRED

- York Counter top 24" × 36" × 2 1/4": **4**
- Brandon 90 mm unit: **20 A**, **20 B**, **18 C**
- Brandon 180 mm unit: **10 A**, **10 B**, **9 C**
- Brandon 90 mm Pillar unit: **18**
- Brandon 180 mm Pillar unit: **15**

NOTE: Appliances and utilities may vary for each project and are not shown on this drawing. This drawing is shown for inspiration only and surplus or shortage of materials may result. It is the user's responsibility to verify for the quantity of materials required. Secure the blocks using a heat resistant concrete adhesive. The installer must ensure that the installation and use of the grill island comply with local regulations and code requirements. Concrete pillars extending to frost line may be required as per local code. Check your local building code before installing.