



2019-20

Plowing Systems,
Horizontal Compaction
Boring Tools
& Accessories

American Made by American Craftsmen

FEATURED PRODUCTS FROM TRIPLE D

Heavy Duty Rock Heads

With Replaceable Carbide Bits

Page 10



Item #HDRH-10200

Insulated Soil Probes

Page 39

Item #ISP-36

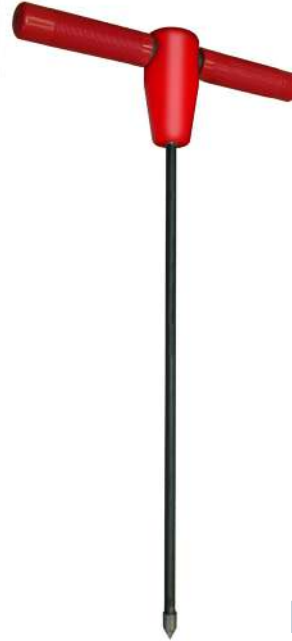

Electrical Protection
up to 45,000 volts

CVMT & CVST Chute Blades

Page 28



VST & VMT Pull Blades

Page 17



For Toro RT600, RT1200, & Case 560 thru 860
(P85, P95 & P105) Plows

Power Bore

Page 16

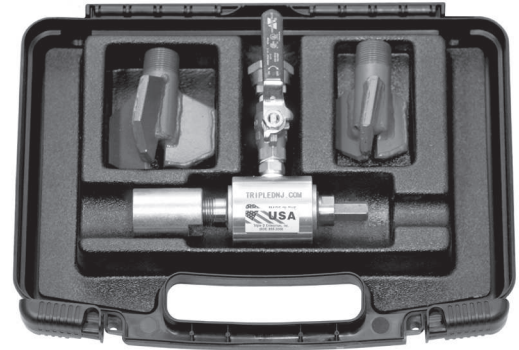

Roto Bore XD

Page 4

Hex drive
Carbide point std.

100% Chrome-moly steel

Push-button lock

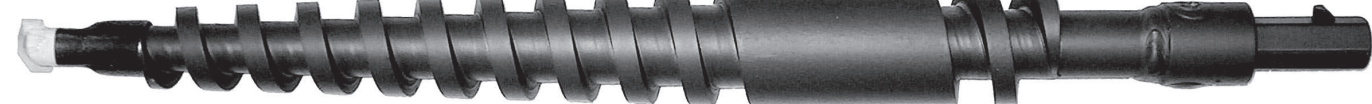

Rock bit
Optional

Ditch Witch
Connection



Shown With New "optional" Rock Bit

**CALL AND ASK ABOUT OUR CUSTOM DESIGN SERVICES
FOR PULLING AND CHUTE BLADES!**

PRODUCT FEATURES & BENEFITS

Plowing Blades and Plowing Accessories

Triple D's primary mission is to provide Contractors "Quality Engineered Products designed to Reduce Down Time, Lower Maintenance Costs and Save Time and Money." To this end, we offer the following information for your consideration:

VIBRATORY PLOWING BLADES

MATERIAL: Except for VALU-BLADES, Triple D plowing blades are manufactured from Ballistic Armor Steel. This is the same grade the U.S. Army uses to armor it's field vehicles. All 1/4" thick plowing blades have a minimum tensile strength of 225,000 psi and a Brinell hardness of 500 (55 Rc). All other Triple D blades have a minimum tensile strength of 180,000 psi and a Brinell hardness of 400 (45 Rc). Most OEM blades have a tensile strength of 100,000 psi and therefore, are not as strong or durable as Triple D's. Additionally, Triple D plowing blades are "thru-hardened" and are guaranteed to be as hard in the center as they are at the surface.

BUSHING, REAMER/BULLET*:

Except as noted, all pulling blades have a precision machined, hardened alloy steel bushing welded to the bottom of the blade (optional on all chute blades). These proprietary bushings provide two unique benefits: 1) a choice of four "interchangeable reamer/bullet" diameters and 2) the use of threaded adapters and lost-motion devices for fast assembly and disassembly. These features provide contractors with greater plowing flexibility and less operational down time.

"HARD GROUND" TOE & BULLET OPTION: A very cost effective blade option for plowing in extremely hard and difficult soil conditions such as hardpan and shale. The "Toe" is manufactured from quality abrasive resistant steel for strength and durability. On pulling and "Combo" chute blades with a replaceable bullet, this option is available on an "Even exchange

basis." An upgrade charge is applicable on all other plowing blades.

A severe duty (SD) bullet system is optional on all plow blades 5/8" thick or thicker with a pull-depth rating of 16 inches or more.

REAMERS/BULLETS - CARBIDE TIPPED*:

Triple D's standard duty plowing blades are designed to accept four (4) sizes of interchangeable carbide tipped blade reamers/bullets.

Since most blade wear occurs at the bottom front of the blade, carbide tipped reamers will, on average, double blade service life. Presently, there are four (4) carbide tipped reamer diameters that fit the B-100 and B-150 blade bushings - 1.5", 1.75", 2.0", and 2.5". The optional 1.75" thru 2.5" sizes have a layer of tungsten carbide impregnated hard-facing material applied to their flanges

that significantly increases their service life.

Our severe duty (SD) reamers are available in diameters from 2.0" thru 4.0", and only fit the B-1750 Bullet/Receiver.

ADJUSTABLE PLOWING DEPTH: Machined into each TL, TR, VS and VMT series plowing blade, is an additional set of machine mounting holes. This allows the contractor to vary plowing depth 3 inches on Case and Vermeer plows and 6" on P85 & P95 plows.

*Not applicable to the Traction style and Valu-Blades.



Manufacturing on the cutting edge of the 21st Century

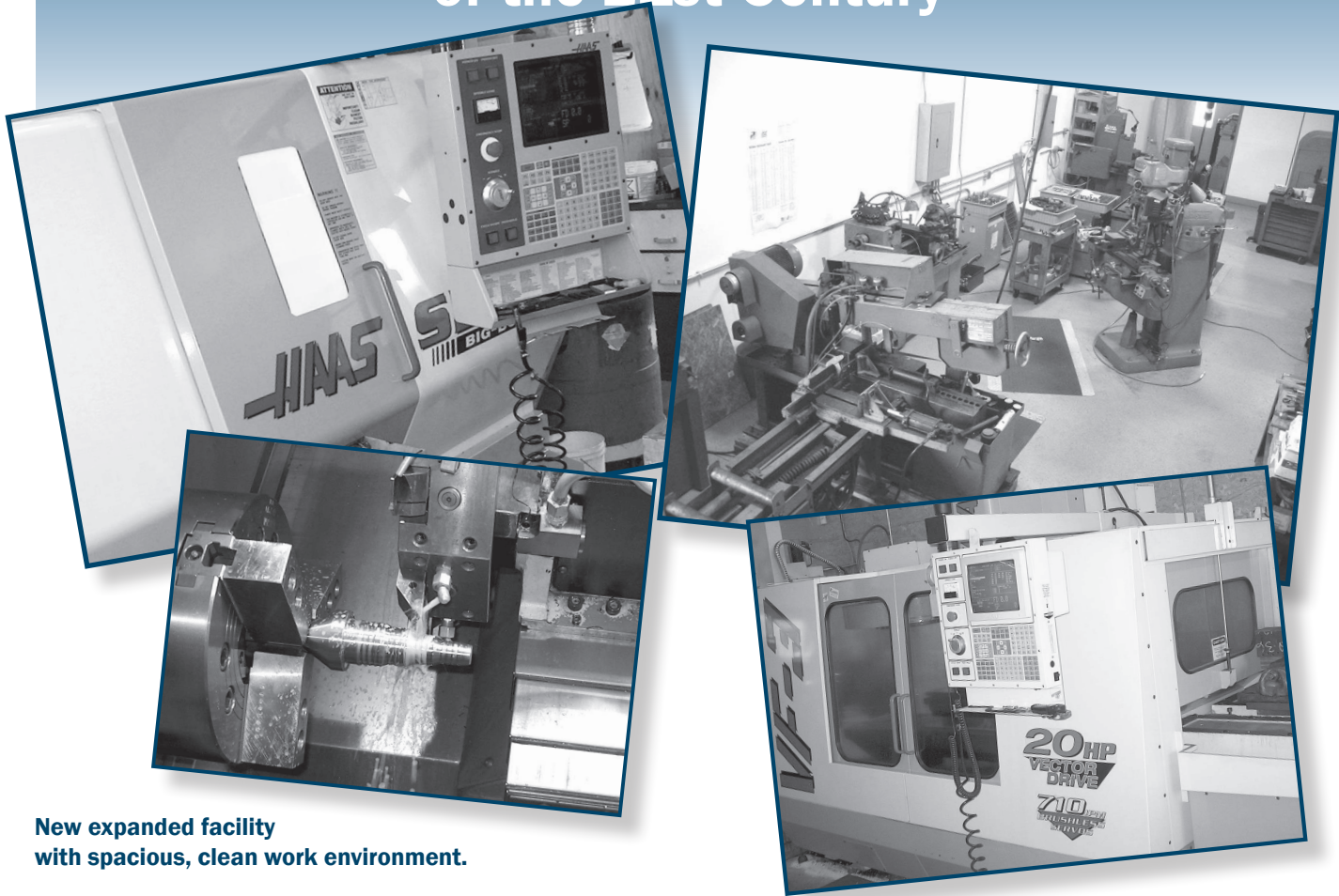

New expanded facility
with spacious, clean work environment.

LOST-MOTION ASSEMBLIES

The purpose of a lost motion assembly is to isolate expensive pipe and cable gripping devices from the reciprocating motion of a plowing blade. Since most vibratory plows vibrate at the rate of 2,000 strokes per minute, directly connecting a gripping device to a plowing blade will cause it to fail prematurely.

Triple D offers several lost-motion assemblies that cover just about every blade/gripping device combination on the market today. Most Triple D assemblies use threaded adapters for ease of attachment, and are manufactured from quality materials for long service life.

MAXI-GRIPS

Maxi-Grips are the most durable, convenient and economical pipe and cable gripping tools on the market today. They use a uniquely designed steel

nose-cone and a replaceable steel mesh grip. Each model has a wide gripping range that will accommodate several sizes of pipe and cable. For instance, an MG-125A will grip 3/4", 1" and 1 1/4" PVC and Poly pipe sizes. A contractor would need to purchase several competitors' gripping devices to pull the same pipe sizes.

Gripping and releasing pipe and cable is much easier and faster than other devices – **NO CLAMPS, CUTTER, HAMMER, DRILL OR TAPE REQUIRED.**

Mesh-grip service life is greatly increased, because it is protected by the solid steel nose-cone and sleeve. Also, when necessary, mesh-grips are easily and inexpensively replaced within a few minutes with a hammer and pin punch.

Contents

Comapction Boring

ROTO-BORE® XD Dry Compaction Bits	4
ROTO-BORE® Standard Dry Compaction Bits	5
MODULAR SANDMOLE.....	5
ROTO-BORE® Dry Compaction Reamers	6
SWIVEL REPAIR KITS	6
ROTO-BORE® Solid Drill Rods.....	7
REPLACEMENT SHANKS.....	7
H.D. DITCH WITCH Solid Drill Rods.....	7
CLIP-TYPE DRILL RODS (CASE CONNECTOR).....	8
Water/Air Swivel Engineered for High-Torque Boring Tools.....	8
DRILL ROD “LOCK” HARDWARE	9
SPADE ROCK HEAD	9
HEAVY DUTY ROCK HEADS With Fixed Carbide Cutters.....	10
HEAVY DUTY ROCK HEADS With Replaceable Carbide Cutter Bits....	10
LEAD AUGERSFor Use With Rock Heads	11
ROTO-BORE® Soil Boring Heads.....	11
ROTO-BORE® Drilling Tool Adapters	12
ROTO-BORE®ADAPTERS Triple D To Triple D.....	13
Accessories.....	13
ROLLER BEARING PULLBACK SWIVEL For Dry Compaction Boring...	14
ROTO-BORE 1”- 8 THREADED WET/AIR ADJUSTABLE REAMERS With Adjustable Reamer Blades.....	14
ROTO-BORE® Wet/Dry Boring Tools	15
POWER-BORE With Water Assist.....	16
Plowing Blades	
“THIN-LINE™” PLOWING BLADES For Toro/Case/Astec, Vermeer Lm25, Lm35 & Lm42, Burkeen B30*	17
Pull Blades For Toro RT600 & RT1200, Case 560 thru 860 (P85, P95 & P105 Plows).....	17
ENDURO PLOWING BLADES for Toro Pro Sneak, Vermeer LM25,LM35 & LM42, Burkeen B30 (Case Mini & Maxi Sneakers).....	18
DELTA PLOWING BLADE For Toro/Case/Astec, Vermeer LM25, LM35 & LM45, and Burkeen B30 Plows.....	19
Hard ground toe options.....	19
VALU-BLADE®.....	19
TURF SHARK.....	20
Hard ground toe options.....	20
HIGH QUALITY PLOWING BLADES For Ditch Witch Plows DW100, VP12, VP252, 255SX, 350SX, 400SX, 410SX.....	21
“SABER CUT™” PLOWING BLADES For Ditch Witch Plows 255SX Thru 410SX.....	22
HARD-FACING OPTION Double The Service Life Of Your New Plowing Blade.....	23
LONG LIFE Blade Points With New Pin Fastening System	23
SD BLADE BULLET SYSTEM.....	24
REPLACEMENT LEADING EDGES For Plow Blades.....	25
ONE PIECE CHUTE BLADES	

Small Radius / Large Radius For Case/Toro P40 Plows, Burkeen B30* Vermeer LM25, LM35/40/42

ONE PIECE CHUTE BLADES Small Radius / Large Radius For Ditch Witch Plows 255SX, 350SX, 400SX, 410SX.....	27
MAXI-TRAC ONE PIECE CHUTE BLADE For Toro RT600, RT1200, & Case 560 thru 860 (P85, P95 & P105) Plows.....	28
MAXI-TRAC CHUTE BLADES For Toro RT600 & RT1200, & Case 560 thru 860 (P85, P95 & P105) Plows.....	29
TRACTION BLADE For Toro Pro Sneak, Vermeer LM25, 35, 40 & 42, Burkeen B30 (Case Mini & Maxi Sneakers) Engineered and Manufactured for Hard, Difficult Soils.....	30
AUSSIE Pulling & One Piece Chute Blades For The Dingo.....	31
PIPE PIPER PLOWING SYSTEM Product Listing.....	32
Kaercher Style Plowing Blades for Kaercher and Pipe Piper Plows .	32
Pipe and Cable Gripping Devices	
MAXIGRIP® Pull Underground Pipe and Cable Quickly and Easily With “Maxi-Grip”® Pipe and Cable Pullers	33
“MAXI-GRIP”® PIPE AND CABLE PULLERS	33
SWIVEL EYE GRIPS.....	34
PULLING GRIPS.....	34
POLY CHAIN GRIP	35
TRAILING BULLETS.....	35
WEDGE-GRIP Pipe and Duct Grip.....	36
LMA-700 H.D. Lost Motion Assembly.....	36
LOST MOTION ASSEMBLIES Used To Connect Pipe And Cable Gripping Devices To Plowing Blades	37
SWIVEL-EYE MAXI-GRIPS.....	38
FIXED HEAD PE PIPE & INNERDUCT PULLING EYES.....	38
Installation Accessories	
SOIL PROBES Noninsulated / Insulated	39
SIDEWALK SPEAR	40
LIGHTING/EDGING AND ROOT CUTTING SPADE	40
ATTACHMENT HARDWARE.....	41
FASTENERS, MOUNTING SHIMS, & HITCH PINS For all Except Pipe Piper	41
HEAVY DUTY CARBIDE TIPPED BLADE BULLETS.....	42
THE TURF HAMMER	42
“RED HEAD” Professional Series Installation Accessories.....	43
Meter Keys	43
Operating Wrench	43
H.D. Steel Dirt Tampers	43
Curb/Service Keys Commercial Series	44
Wire Rope Pulling Slings	44
WARRANTY.....	45

ROTO-BORE® XD

Dry Compaction Bits

With Replaceable CARBIDE POINT* and exclusive
DOUBLE SQUARE THREAD for faster drilling.



The new **ROTO-BORE® XD** dry compaction bit from Triple D features a revolutionary new design that enables fast penetration and longer tool life with far less thrust pressure so you can get the job done quickly!

All **ROTO-BORE BITS** are machined from solid chrome-moly steel bar stock on state-of-the-art CNC lathes and machining centers. All bits are quenched and tempered to an average tensile strength of 153,000 psi for optimum strength and toughness.

The replaceable fluted carbide point uses an innovative, premium carbide that will significantly increase productivity and profitability by boring up to 40% faster and lasting up to 300% longer than standard style bits.

* Point can be changed within minutes.

ROTO-BORE® PUSH BUTTON XD BITS		
Part No.	Bit Diameter	Hex Size
XD-01175	1.75"	13/16"
XD-01200	2.00"	13/16"
XD-01250	2.50"	13/16"
XD-01300	3.00"	13/16"
XD-02175	1.75"	1"
XD-02200	2.00"	1"
XD-02250	2.50"	1"
XD-02300	3.00"	1"

REPLACEMENT CARBIDE POINT		
Part No.	Bit Diameter	Connector Size
XD-100	ALL	All



XD ROCK BIT (OPTIONAL)	
Part No.	Bit Diameter
XDRH-1375	1.375"
XDRH-1375X	Exchange XDRH-1375 for XD-100



DITCH WITCH "XD" COMPACTION BITS		
Part No.	Bit Diameter	Hex Size
XD-03175	1.75"	7/8" D.W.
XD-03200	2.00"	7/8" D.W.
XD-03250	2.50"	7/8" D.W.
XD-03300	3.00"	7/8" D.W.



TORO/CASE/ASTEC "XD" COMPACTION BITS		
Part No.	Bit Diameter	Hex Size
XD-04175	1.75"	7/8" Case
XD-04200	2.00"	7/8" Case
XD-04250	2.50"	7/8" Case
XD-04300	3.00"	7/8" Case

ROTO-BORE®

“Standard” Dry Compaction Bits

Now With Double Square Thread For Faster Boring*

These high quality tools are for dry-boring in clay and other compressible soils. They are self-feeding and produce clean, compacted borings.

All **ROTO-BORE BITS** are machined from solid chrome-moly steel bar stock on state-of-the-art CNC lathes and machining centers. All bits are quenched and tempered to an average tensile strength of 153,000 psi for optimum strength and toughness.

The bit's screw thread is much heavier than most competitors' designs. This heavy-duty design assures contractors a long service life and lower operating costs.



PUSH BUTTON LOCK		
Part No.	Bit Diameter	Hex Size
M-01150	1.50"	13/16"
M-01175	1.75"	13/16"
M-01200	2.00"	13/16"
M-01250	2.50"	13/16"
M-01300	3.00"	13/16"
M-02150	1.50"	1"
M-02175	1.75"	1"
M-02200	2.00"	1"
M-02250	2.50"	1"
M-02300	3.00"	1"

*Excludes 1.5" Mole

Note: For larger holes than those above, use ROTO-BORE BITS in conjunction with our dry compaction ROTO-BORE REAMERS.



Ditch Witch Connector

DITCH WITCH STD. COMPACTION BITS		
Part No.	Bit Diameter	Hex Size
M-03150	1.50"	7/8" D.W.
M-03175	1.75"	7/8" D.W.
M-03200	2.00"	7/8" D.W.
M-03250	2.50"	7/8" D.W.
M-03300	3.00"	7/8" D.W.



Case/Astec Connector

TORO/CASE/ASTEC STD. COMPACTION BITS		
Part No.	Bit Diameter	Hex Size
M-04150	1.50"	7/8" Case
M-04175	1.75"	7/8" Case
M-04200	2.00"	7/8" Case
M-04250	2.50"	7/8" Case
M-04300	3.00"	7/8" Case

MODULAR SANDMOLE

The **Modular Sandmole** offers extra long flighting for use in unfavorable sand conditions where a cave-in is possible.

Generally, a front section is used along with one back section to create a 37" long sandmole. For better performance, you can use additional back sections to increase length, pull and stability.

Front and back sections are machined from solid chrome-moly alloy steel billets for strength and

durability. Each section is heat treated to an average tensile strength of 150,000 psi.

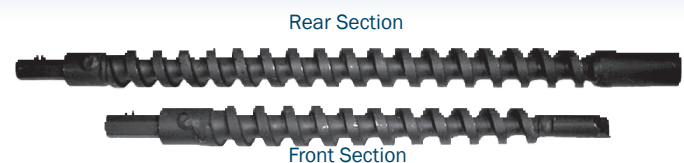

MODULAR SANDMOLE - 1.5" DIA		
Part No.	Description	Hex Size
SM-01150F	Front Section	13/16"
SM-01150R	Rear Section	13/16"

ROTO-BORE®

Dry Compaction Reamers

Used to enlarge holes in compressible soil, these high quality back-reamers are self-feeding and produce clean, compacted holes.

ROTO-BORE REAMERS are machined from **solid chrome-moly steel bar stock** on state-of-the-art CNC lathes and machining centers. All reamers are heat-treated to an average tensile strength of 153,000 psi for optimum strength and toughness.

Note: For maximum performance and tool life, back-reaming should be done incrementally, one-inch at a time, i.e. 2", 3" etc.



PUSH BUTTON LOCK			
Part No.	Reamer Diameter	Hex Size	Barrel End
R-01200	2.00"	13/16"	Swivel
R-01250	2.50"	13/16"	Swivel
R-01300	3.00"	13/16"	Swivel
R-01350	3.50"	13/16"	Swivel
R-01400	4.00"	13/16"	Swivel
R-01450	4.50"	13/16"	Swivel
R-02200	2.00"	1.0"	Swivel
R-02250	2.50"	1.0"	Swivel
R-02300	3.00"	1.0"	Swivel
R-02350	3.50"	1.0"	Swivel
R-02400	4.00"	1.0"	Swivel
R-02450	4.5"	1.0"	Swivel
R-02500	5.0"	1.0"	Swivel
R-02600	6.0"	1.0"	Swivel



CASE/ASTEC (CLIP-TYPE) DRY COMPACTION REAMERS			
Part No.	Bit Diameter	Hex Size	Barrel End
R-04200	2.00"	7/8"	Swivel
R-04250	2.50"	7/8"	Swivel
R-04300	3.00"	7/8"	Swivel
R-04350	3.50"	7/8"	Swivel
R-04400	4.00"	7/8"	Swivel
R-04450	4.50"	7/8"	Swivel
R-04500	5.00"	7/8"	Swivel
R-04600	6.00"	7/8"	Swivel



DITCH WITCH DRY COMPACTION REAMERS			
Part No.	Bit Diameter	Hex Size	Barrel End
R-03200	2.00"	7/8" D.W.	Swivel
R-03250	2.50"	7/8" D.W.	Swivel
R-03300	3.00"	7/8" D.W.	Swivel
R-03350	3.50"	7/8" D.W.	Swivel
R-03400	4.00"	7/8" D.W.	Swivel
R-03450	4.50"	7/8" D.W.	Swivel
R-03500	5.00"	7/8" D.W.	Swivel
R-03600	6.00"	7/8" D.W.	Swivel

SWIVEL REPAIR KITS

The following three Swivel Repair Kits are available for Triple D compaction backreamers. Each Kit contains a forged steel eye, mounting bolt and special nut. **Welding is required.**



* These swivels do not rotate under load. They will only release torsional load when pulling load is relieved.

SWIVEL REPAIR KIT	
Part No.	Fits
SRK-200	2.0" & 2.5" BACKREAMERS
SRK-300	3.0" & 3.5" BACKREAMERS
SRK-400	4.0" & 4.5" BACKREAMER

ROTO-BORE®

Solid Drill Rods

High quality drill rods for drilling the most difficult soil conditions. All drill rods are constructed of **solid** chrome-moly steel bars that are heat-treated to an average tensile strength of 153,000 psi for optimum strength, toughness and flexibility.

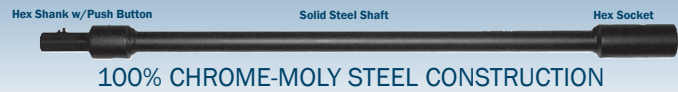

PERFORMANCE FEATURES

1. Convenient **“Push Button”** lock for quick assembly and disassembly.
2. Solid, heat treated, drill rod shafts for strength, durability and flexibility – 7/8” and 1” available.
3. Available in **13/16” HEX** or Heavy-Duty **1” HEX** Drive Connectors.
4. Versatile and convenient drill rod lengths of **2’, 4’, 5’, 8’, and 10’**.
5. **Adapters** available to fit most popular drilling equipment.

SOLID DRILL RODS			
Part No.	Length	Hex Drive	Shaft Dia.
DR-24	2 FT.	13/16”	7/8”
DR-48	4 FT.	13/16”	7/8”
DR-60	5 FT.	13/16”	7/8”
DR-96	8 FT.	13/16”	7/8”
DR-120	10 FT.	13/16”	7/8”
DR-48X	4 FT.	13/16”	1”
DR-60X	5 FT.	13/16”	1”
DR-96X	8 FT.	13/16”	1”
DR-120X	10 FT.	13/16”	1”
DR-02-48	4 FT.	1”	1”
DR-02-60	5 FT.	1”	1”
DR-02-96	8 FT.	1”	1”
DR-02-120	10 FT.	1”	1”

DRILL ROD REPLACEMENT ENDS/SHANKS

REPLACEMENT HEX SHANKS		
Part No.	Hex Drive	Rod Dia.
HS-1316	13/16”	7/8”
HS-1316X	13/16”	1”
HS-2100	1”	1”
HS-2100A	1”	7/8”

BUTTON REPAIR KIT*	
Part No.	Hex Drive
BRK-1316	13/16”
BRK-2000	1”

*Kit contains 5 Buttons, 5 Springs, 5 Stainless Steel Retainer Screws and one (1) Hex Wrench.

REPLACEMENT HEX SOCKETS		
Part No.	Hex Drive	Rod Dia.
SO-1316	13/16”	7/8”
SO-1316X	13/16”	1”
SO-2100	1”	1”

H.D. DITCH WITCH

Solid Drill Rods



For contractors that prefer the Ditch Witch style drill rod connector (Latch Style), but desire the strength and rigidity of a 1” diameter drill rod shaft for straighter drilling and control, Triple D has developed a new heavy duty series of drill rods that are interchangeable with Ditch Witch horizontal drill rods and tooling.

The heavy duty rod shafts and connectors are manufactured from chrome-moly tool steel that is heat-treated to an average tensile strength of 153,000 psi for strength, toughness and rigidity.

Note: Ditch Witch is a registered trademark of The Charles Machine Works, Inc. of Perry, OK, and is used for reference purposes only.

H.D. DITCH WITCH DRILL RODS			
Part No.	Length	Hex Drive	Shaft Dia.
DR-03-48X	4’	7/8” D.W.	1”
DR-03-60X	5’	7/8” D.W.	1”
DR-03-96X	8’	7/8” D.W.	1”
DR-03-120X	10’	7/8” D.W.	1”

DRILL ROD REPLACEMENT PARTS	
Part No.	Description
HS-03-875	Hex Shank for 7/8” dia. Shaft
HS-03-875A	Hex Shank for 1” dia. Shaft
HS-03-910*	Hex Shank for Factory Rods
SO-03-875	Hex Socket for 7/8” dia. Shaft
SO-03-875A	Hex Socket for 1” dia. Shaft
SO-03-910*	Hex Socket for Factory Rods
LK-100	Latch Kit for Ditch Witch drill rod shank

* Fits Ditch Witch factory rods.

CLIP-TYPE DRILL RODS

(TORO/CASE CLIP CONNECTOR*)



100% CHROME-MOLY STEEL CONSTRUCTION

Triple D's ROTO-BORE® drill rods are now available with "Clip-type" TORO/CASE* connectors.

Our Clip-type drill rods feature the same high quality, heat-treated, solid chrome-moly steel shafts used in our popular push-button type drill rods. The Clip-type hex shanks and sockets are also manufactured from the same high quality, solid chrome-moly steel for strength and toughness. Average tensile strength of these drill rods is 150,000 p.s.i.

Clip-type drill rods are available in 5 ft., 8 ft., and 10 ft. lengths, and with 7/8" or 1" dia. shafts.

CLIP-TYPE REPLACEMENT PARTS

Part No.	Shaft Diameter	Rod Length
DRC-60	7/8"	60"
DRC-96	7/8"	96"
DRC-120	7/8"	120"
DRC-02-60	1"	60"
DRC-02-96	1"	96"
DRC-02-120	1"	120"

CLIP-TYPE REPLACEMENT PARTS

Part No.	Description
HS-04-875	HEX SHANK FOR 7/8" SHAFT
HS-04-875A	HEX SHANK FOR 1" SHAFT
SO-04-875	HEX SOCKET FOR 7/8" SHAFT
SO-04-875A	HEX SOCKET FOR 1" SHAFT
CL-1000	"CLIPS" FOR CONNECTORS (PACK OF 5)

*CASE is a trademark of Fiat Corp.

Water/Air Swivel

Engineered for High-Torque Boring Tools

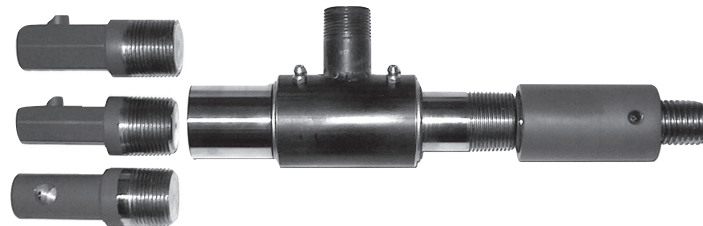

Triple D's heavy-duty water/air swivel is designed with o-ring seals, bronze bearings, grease fittings and a heat-treated chrome-moly steel shaft for high torque applications. May be used on trenchers with mounted boring attachment and our high strength hollow drill rods.

ROTO-BORE® Water/Air Swivel

Part No.	Description
WAS-1000	SWIVEL BODY
WAS-2000	7/8" ROD COUPLING
WAS-2100	1.0" ROD COUPLING
WAS-5000	13/16" HEX DRIVE SHANK
WAS-6000	1.0" HEX DRIVE SHANK
WAS-7000	7/8" HEX DITCH WITCH DRIVE SHANK
WAS-8000	1.0" ROUND DRIVE SHANK
WAS-9000	7/8" HEX ASTEC/CASE DRIVE SHANK

DRILL ROD "LOCK" HARDWARE

To insure quality control, the following Drill Rod "LOCK" hardware is manufactured by TRIPLE D. The two lock "buttons" and "latch" are manufactured from chrome-moly steel, then quenched and tempered to an average tensile strength of 150,000 p.S.I. For toughness.

REPLACEMENT HARDWARE		
Part No.	Description	Package Quantity
BRK-1316*	Button Repair Kit for 13/16" Hex	5
BRK-2000*	Button Repair Kit for 1" Hex	5
LK-100	Latch Repair Kit for Ditch Witch	1
CL-1000	"Clips" for Clip-Type Rods - Case	5

* Includes one (1) hex wrench.



LK-100 Fits Ditch Witch & Triple D



CL-1000 Fits Clip-type Rods



BRK-1316* Fits 13/16" Hex



BRK-2000* Fits 1" Hex

SPADE ROCK HEAD*

Triple D's "Spade Rock Heads" are manufactured from the finest tool steel and carbide available to create one aggressive, tough, long lasting and inexpensive drill bit. Conical carbide cutters are strategically positioned to aggressively drill through those nasty soils. The heat-treated, abrasive resistant steel body is 3/4" thick and is hard-faced on all major wear edges for long life.

Best used with a Lead Auger to remove millings.

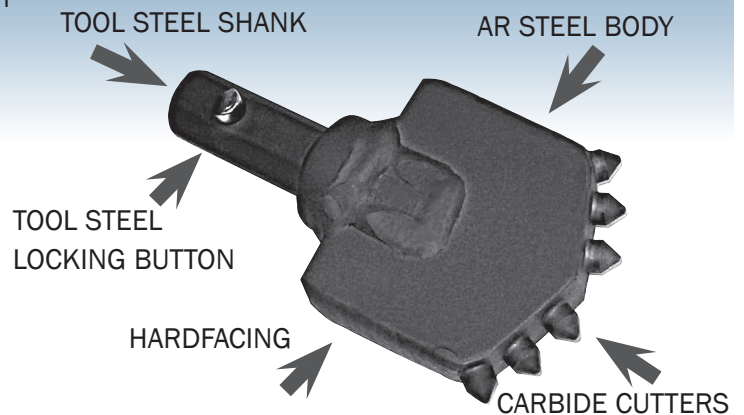

SPADE ROCK HEADS							
Part No.	Bit Diameter	Hex Size	H.D Rock Heads Fits	Model No.	Bit Diameter	Hex Size	Fits
SRH-01300	3.0"	13/16"	Triple D	SRH-03300	3.0"	7/8"	Ditch Witch
SRH-01350	3.5"	13/16"	Triple D	SRH-03350	3.5"	7/8"	Ditch Witch
SRH-01400	4.0"	13/16"	Triple D	SRH-03400	4.0"	7/8"	Ditch Witch
SRH-01450	4.5"	13/16"	Triple D	SRH-03450	4.5"	7/8"	Ditch Witch
SRH-02300	3.0"	1"	Triple D	SRH-04300	3.0"	7/8"	Case/Astec
SRH-02350	3.5"	1"	Triple D	SRH-04350	3.5"	7/8"	Case/Astec
SRH-02400	4.0"	1"	Triple D	SRH-04400	4.0"	7/8"	Case/Astec
SRH-02450	4.5"	1"	Triple D	SRH-04450	4.5"	7/8"	Case/Astec

* Not for Solid Rock.

HEAVY DUTY ROCK HEADS*

With Fixed Carbide Cutters

These Heavy Duty Rock Heads are designed for drilling holes in hard clays, shale, hardpan, sandstone and root impregnated areas. The cutting faces and edges are coated with tungsten carbide impregnated hardfacing material for maximum durability. The tool bodies are manufactured from chrome-moly tool steel, and the carbide cutting blades are made in the USA.

NOTE: for maximum performance and bit life, use these bits with a Lead Auger to remove millings from boring.

Part No.	Bit Diameter	Hex Size	H.D Rock Heads Fits	H.D Rock Heads Model No.	Bit Diameter	Hex Size	Fits
RH-1175	1.75"	13/16"	Triple D	RH-3175	1.75"	7/8"	Ditch Witch
RH-1200	2.00"	13/16"	Triple D	RH-3200	2.00"	7/8"	Ditch Witch
RH-1250	2.50"	13/16"	Triple D	RH-3250	2.50"	7/8"	Ditch Witch
RH-1300	3.00"	13/16"	Triple D	RH-3300	3.00"	7/8"	Ditch Witch
RH-1400*	4.00"	13/16"	Triple D	RH-3400	4.00"	7/8"	Ditch Witch
RH-1500*	5.00"	13/16"	Triple D	RH-3500	5.00"	7/8"	Ditch Witch
RH-2175	1.75"	1"	Triple D	RH-4175	1.75"	7/8"	Case/Astec
RH-2200	2.00"	1"	Triple D	RH-4200	2.00"	7/8"	Case/Astec
RH-2250	2.50"	1"	Triple D	RH-4250	2.50"	7/8"	Case/Astec
RH-2300	3.00"	1"	Triple D	RH-4300	3.00"	7/8"	Case/Astec
RH-2400*	4.00"	1"	Triple D	RH-4400	4.00"	7/8"	Case/Astec
RH-2500*	5.00"	1"	Triple D	RH-4500	5.00"	7/8"	Case/Astec

*Not for solid rock

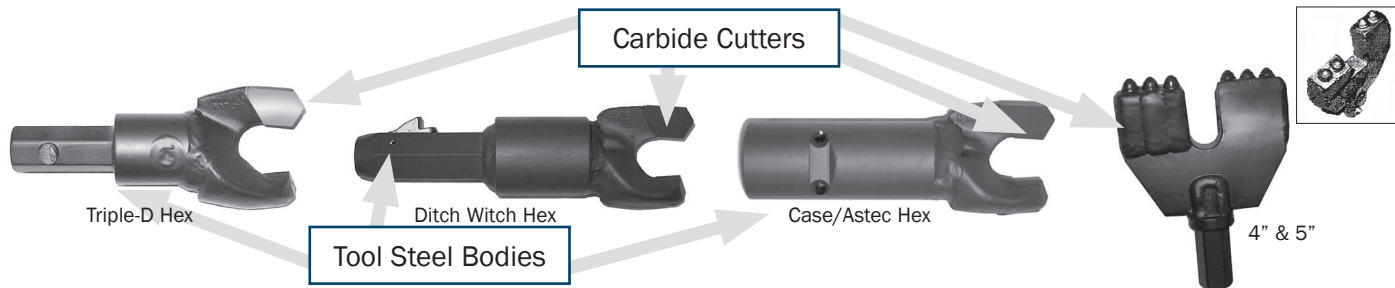

HEAVY DUTY ROCK HEADS

With Replaceable Carbide Cutter Bits

HD ROCK HEADS WITH REPLACEABLE CARBIDE CUTTER BITS		
Part No.	Bit Diameter	Hex Size
HDRH-10200	2.00"	13/16"
HDRH-20200	2.00"	1"
HDRH-30200	2.00"	7/8" D.W.
HDRH-40200	2.00"	7/8" Case
HDRH-50000	Replacement Carbide Cutting Bit	
HDRH-50100	Replacement Cotter Pin	

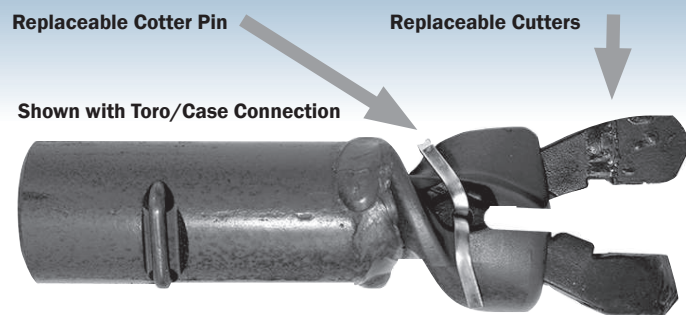

LEAD AUGERS

For Use With Rock and Soil Boring Heads

Lead augers are used behind rock heads to capture and remove millings when they are withdrawn from the bore hole. SOLID ROD!



LEAD AUGERS							
Part No.	Diameter	Length	Drive Size	Part No.	Diameter	Length	Drive Size
A-011875-4	1 7/8"	4 ft.	13/16" Hex	A-031875-4	1 7/8"	4 ft.	7/8" DW
A-012375-4	2 3/8"	4 ft.	13/16" Hex	A-032375-4	2 3/8"	4 ft.	7/8" DW
A-012875-4	2 7/8"	4 ft.	13/16" Hex	A-032875-4	2 7/8"	4 ft.	7/8" DW
A-013250-4	3 1/4"	4 ft.	13/16" Hex	A-033250-4	3 1/4"	4 ft.	7/8" DW
A-013500-4	3 1/2"	4 ft.	13/16" Hex	A-033500-4	3 1/2"	4 ft.	7/8" DW
A-014250-4	4 1/4"	4 ft.	13/16" Hex	A-034250-4	4 1/4"	4 ft.	7/8" DW
A-021875-4	1 7/8"	4 ft.	1" Hex	A-041875-4	1 7/8"	4 ft.	7/8" Case
A-022375-4	2 3/8"	4 ft.	1" Hex	A-042375-4	2 3/8"	4 ft.	7/8" Case
A-022875-4	2 7/8"	4 ft.	1" Hex	A-042875-4	2 7/8"	4 ft.	7/8" Case
A-023250-4	3 1/4"	4 ft.	1" Hex	A-043250-4	3 1/4"	4 ft.	7/8" Case
A-023500-4	3 1/2"	4 ft.	1" Hex	A-043500-4	3 1/2"	4 ft.	7/8" Case
A-024250-4	4 1/4"	4 ft.	1" Hex	A-044250-4	4 1/4"	4 ft.	7/8" Case

*5 ft. and 10 ft. lengths available upon request.

ROTO-BORE®

Soil Boring Heads*

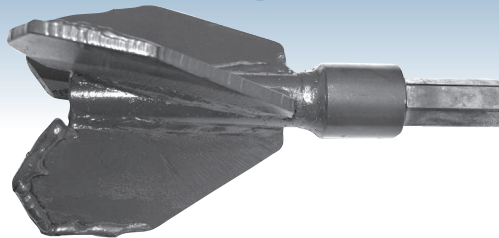

Push Button Type	
Part No.	Description
SBH-01300	3.00" DIA. with 13/16" Hex Shank
SBH-01400	4.00" DIA. with 13/16" Hex Shank
SBH-01450	4.50" DIA. with 13/16" Hex Shank
SBH-02300	3.00" DIA. with 1" Hex Shank
SBH-02400	4.00" DIA. with 1" Hex Shank
SBH-02450	4.50" DIA. with 1" Hex Shank

Ditch Witch Type	
Part No.	Description
SBH-03300	3.00" DIA. with D.W. Hex Shank
SBH-03400	4.00" DIA. with D.W. Hex Shank
SBH-03450	4.50" DIA. with D.W. Hex Shank

Case/Toro Type	
Part No.	Description
SBH-04300	3.00" DIA. with CLIP-TYPE Socket
SBH-04400	4.00" DIA. with CLIP-TYPE Socket
SBH-04450	4.50" DIA. with CLIP-TYPE Socket

* Highly recommended that lead augers be used with these bits.

ROTO-BORE®

Drilling Tool Adapters*

The following drilling tool adapters are used to attach Triple D's ROTO-BORE® drill rods and accessories to the listed boring equipment: .



Triple D to Case/Astec Hydra-Borer	
Part No.	Description
ADC-1000	1" round male to 7/8" clip-type male.
ADC-1200	Clip-type male to 13/16" hex male.
ADC-1300	1" round male to 13/16" hex female. (Hydra-Borer U-Joint to Triple D)
ADC-2300	1" round male to 1" hex female. (Hydra-Borer U-Joint to Triple D)
ADC-1400	Clip-type female to 13/16" hex female.
ADC-2400	Clip-type female to 1" hex female.
ADC-1100	Clip-type male to 13/16" hex female. (Triple-D bits & rods to Case drill rods)
ADC-2100	Clip-type male to 1" hex female. (Triple-D bits & rods to Case drill rods)

Triple D to Vermeer	
Part No.	Description
ADV-1400	1" X 8 thd. female to 13/16" hex female. (Vermeer boring attachment to T-D)
ADV-2400	1" X 8 thd. female to 1" hex female. (Vermeer boring attachment to T-D)

Triple D to Ditch Witch	
Part No.	Description
ADW-1000	1" round male to 7/8" Ditch Witch female.
ADW-1200	7/8" hex male to 13/16" hex female. (Roto-Witch to Triple D)
ADW-2200	7/8" hex male to 1" hex female. (Roto-Witch to Triple D)
ADW-1400	7/8" hex female to 13/16" hex female.
ADW-2400	7/8" hex female to 1" hex female.
ADW-1500	13/16" hex male to 7/8" hex female. (D.W. tooling to Triple D rods)
ADW-2500	1" hex male to 7/8" hex female. (D.W. tooling to Triple D rods)
ADW-1210	1 3/8" x 6 spline to 13/16" hex female. (Roto-Witch U-Joint to Triple D)
ADW-2210	1 3/8" x 6 spline to 1" hex female. (Roto-Witch U-Joint to Triple D)
ADW-3000	1 3/8" x 6 spline to 7/8" Ditch Witch socket

Continued next page.

* The above adapters are the most commonly used. If you do not see what you need, call and we will be glad to make the adapter for you.

NOTE: All manufacturer's names, symbols, and descriptions are used for reference purposes only, and none of the products listed are the products of these manufacturers.

ROTO-BORE® ADAPTERS

Triple D To Triple D

Allows contractors to use Standard (13/16" Hex) drill rods with Heavy Duty (1" Hex) tools and vice-versa - Heavy Duty (1" Hex) drill rods with Standard (13/16" Hex) tooling.

Part No.	Description
ATD-1500	13/16" Hex Male to 1" Hex Female
ATD-2500	1" Hex Male to 13/16" Hex Female
ATD-3000	1" Hex Female to 13/16" Hex Female

Drill Adapter

Part No.	Description
ATD-4000	1/2" Shank x 13/16" Hex Female
ATD-5000	Spline Shank x 13/16" Hex Female



ATD-1500



ATD-2500



ATD-3000

Accessories

Roto-Bore Swivel Shank*

An economical swivel that is manufactured from chrome-moly steel for strength and long service life. This swivel is used to pull back service when enlargement of the hole is not necessary.



CASE/TORO



HEX DRIVE

Part No.	Connector
SS-03-875	7/8" Ditch Witch Hex Connection
SS-04-875	7/8" Case/Astec Hex Connection

Part No.	Connector
SS-1316	13"/16" HEX
SS-2000	1" HEX

* Not for Rotational Pull Back

Heavy Duty PTO U-Joint Assembly Made in U.S.A.

A high quality, forged steel U-Joint designed to attach ROTO-BORE® drill rods to plow and trencher boring motors that are equipped with a 1 3/8" - 6 spline PTO Shaft. This unit must be used in conjunction with our ADC-1300 or ADC-2300 adapters to accommodate the Hex Shanks of our drill rods.



Part No.	Description
UJA-100	1 3/8" - 6 Spline x 1" Bore

Locking Button Pliers

Designed for fast and easy unlocking of button connectors. The pliers lock onto the rod end while depressing the button, allowing the use of both hands to disconnect the tool.



Part No.	Description	Shank Size
LP-1000	Locking Pliers	13/16"
LP-2000	Locking Pliers	1"

Roto-Bore® Drill Rod Guide

Used to align and support the Lead Drill Rod, just behind the Compaction Bit, at the start of the bore. This tool allows the operator's assistant to safely perform this task **while standing outside and to the right of the entrance trench.**

THE USE OF HANDS, FEET OR TOOLS OTHER THAN THE DRILL ROD GUIDE TO ALIGN THE BORE CAN RESULT IN SERIOUS BODILY INJURY OR DEATH.

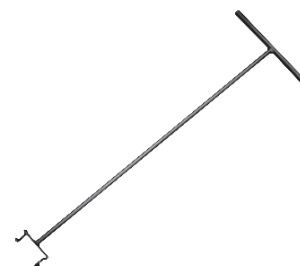

Part No.	Length
DRG-48	48"

ROLLER BEARING PULLBACK SWIVEL

For Dry Compaction Boring

This roller bearing swivel is designed to isolate equipment's rotational torque from the pipe or cable being pulled through an underground boring. Several adapters are available to attach this swivel to various ROTO-BORE® tooling. The current selection of adapters include a weld-on stud for attachment to a backreamer and snap-in adapters for each of our drill rods.

This quality pullback swivel uses a roller thrust bearing assembly to handle thrust loads up to 4,000 lbs. For even greater anti-friction, anti-wear performance, the swivel also contains two additional bronze bearings and a recess protected grease fitting for flushing after each use.

Part No.	Description
CB-100	Pullback Swivel Assembly w/o Adapter
CB-100A	Replacement Bearing Kit for Pullback Swivel
CB-300A	Ditch Witch Adapter
CB-400A	Case/Astec Adapter
CB-500A	1" Hex Adapter
CB-600A	13/16" Hex Adapter
CB-700A	Weld-on Stud Adapter



CB-100



CB-300A



CB-400A

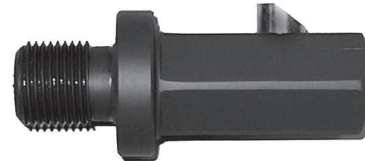

CB-500A

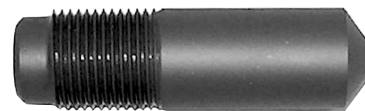

CB-700A

ROTO-BORE 1"- 8 THREADED WET/AIR ADJUSTABLE REAMERS

With Adjustable Reamer Blades

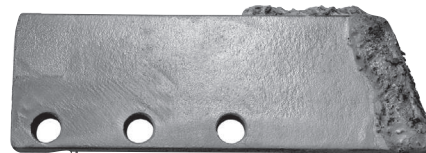
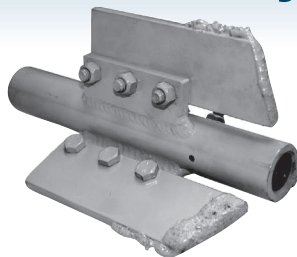

Part No.	Description
RA-400AW	4" Reamer, Complete with hardfaced Reamer Blades
RA-500AW	5" Reamer, Complete with hardfaced Reamer Blades
RA-600AW	6" Reamer, Complete with hardfaced Reamer Blades
RA-800AW	8" Reamer, Complete with hardfaced Reamer Blades
RA-1000AW	10" Reamer, Complete with hardfaced Reamer Blades
RA-1200AW	12" Reamer, Complete with hardfaced Reamer Blades

Part No.	Description
RAB-400	4" Hardfaced Adjustable Reamer Blades
RAB-500	5" Hardfaced Adjustable Reamer Blades
RAB-600	6" Hardfaced Adjustable Reamer Blades
RAB-800	8" Hardfaced Adjustable Reamer Blades
RAB-1000	10" Hardfaced Adjustable Reamer Blades
RAB-1200	12" Hardfaced Adjustable Reamer Blades

ROTO-BORE®

Wet/Dry Boring Tools



WET/AIR/DRY ALLOY TUBE DRILL RODS	
Part No.	Description
CASE/ASTEC "CLIP-TYPE" CONNECTION	
DRC-02-60AW	60" X CASE/ASTEC HEX DRIVE X 1" ALLOY TUBE
DRC-02-120AW	120" X CASE/ASTEC HEX DRIVE X 1" ALLOY TUBE
1" X 8 THREADED CONNECTION	
DRT-02-60AW	60" X 1" THREADED CONNECTION X 1" ALLOY TUBE
DRT-02-120AW	120" X 1" THREADED CONNECTION X 1" ALLOY TUBE
7/8" X 9 THREADED CONNECTION	
DRT-78-60AW	60" X 7/8" THREADED CONNECTION X 1" ALLOY TUBE
DRT-78-120AW	120" X 7/8" THREADED CONNECTION X 1" ALLOY TUBE
CASE/ASTEC WET/AIR ROCK HEADS (SANDSTONE, LOOSE ROCK, SHALE)	
RH-4200AW	2.00" DIA., CLIP-TYPE CONNECTOR W/THRU HOLE
RH-4250AW	2.50" DIA., CLIP-TYPE CONNECTOR W/THRU HOLE
RH-4300AW	3.00" DIA., CLIP-TYPE CONNECTOR W/THRU HOLE
1" X 8 THREADED WET/AIR ROCK HEADS (SANDSTONE, LOOSE ROCK, SHALE)	
RH-5200AW	2.00" DIA., 1" THREADED CONNECTOR
RH-5250AW	2.50" DIA., 1" THREADED CONNECTOR
RH-5300AW	3.00" DIA., 1" THREADED CONNECTOR
7/8" X 9 THREADED WET/AIR ROCK HEADS (SANDSTONE, LOOSE ROCK, SHALE)	
RH-7200AW	2.00" DIA., 7/8 THREADED CONNECTOR
RH-7250AW	2.50" DIA., 7/8 THREADED CONNECTOR
RH-7300AW	3.00" DIA., 7/8 THREADED CONNECTOR
REPLACEMENT WET/AIR SHANKS AND SOCKETS	
HS-04-562AW	CASE/ASTEC WET/AIR SHANK FOR 1" ALLOY DRILL TUBE
SO-04-875A	CASE/ASTEC HEX SOCKET FOR 1" ALLOY DRILL TUBE/SHAFT
HS-04-0	"O" RING FOR CASE/ASTEC WET/AIR SHANK
SO-100	SOCKET, THREADED 1" X 8 W/O SS
SO-100SS	SOCKET, THREADED 1" X 8 W/ SS
SOC-200	CONNECTOR, THREADED W THRU HOLE, 1" X 8 THD
SO-780	SOCKET, THREADED 7/8" X 9 W/O SS
SO-780SS	SOCKET, THREADED 7/8" X 9 W/ SS
SOC-700	CONNECTOR, THREADED W/ THRU HOLE, 7/8" X 9 THD

POWER-BORE

With Water Assist

No longer do you need to pound pipe, rods or use water jetting when you run pipe or wiring underground

SAVE TIME & MONEY by boring under Walkways, Driveways, Patios, Landscaping, & More.

Can be used in most soil conditions including sand, loam, hard clay, shale, and gravel/sand mix.

Small roots and stones will not stop it.

Kit Includes:

- Power-Bore Assembly
- 2" & 3" Boring Bits
- Machined alloy steel coupling for connecting customer supplied drillpipe to the Power-Bore Tool.
- Machined brass water valve and female hose coupling.
- Durable fitted plastic case.

Additional items needed for use not included:

- 1/2" or larger industrial drill, turning a constant 300 to 500 RPM.
- Drill Pipe: 3/4" sch 40 galvanized or black pipe threaded on both ends in 3' to 10' lengths. American made is recommended for strength and durability.
- Water Service.

Safety:

Always use a portable GFI receptacle with electric drill. Always notify the local one-call system prior to boring or plowing.

Always expose the utilities near your work by a non-destructive method before excavating, plowing or boring.

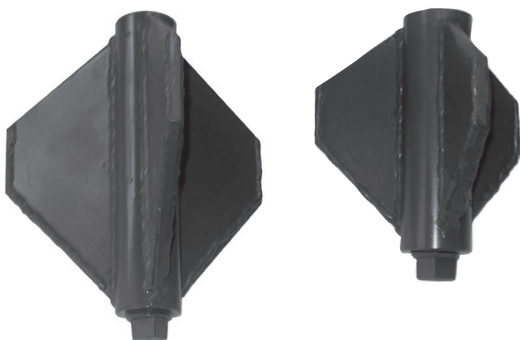

Durable, Lightweight, Affordable, 100% Made in the USA.



Power-Bore	
Part No.	Description
PB-9005	Power Bore Kit w/2" & 3" Bits in Case
PB-9000	Power Bore Swivel Assembly only
PB-8000	Housing, Aluminum
PB-8005	Drive Shaft, Heat Treated 4140
PB-8007	Hex Driver, Heat Treated 4140
PB-8010	Reducing Bushing, 1/2" NPTF x 3/4" NPS
PB-8012	HD 3/4" NPS Pipe Coupling
PB-8015	Pipe Nipple, 3/8" NPT, Brass Hex
PB-8020	Adapter, Garden Hose, 3/8" NPTM x 3/4" GHF
PB-8025	Ball Valve, 3/8" NPTF, Brass
PB-8030	Retaining Ring, 7/8" Shaft Size
PB-8035	O-Ring, Viton - 7/8" ID x 1/16" Sect.
PB-8040	Flanged Sleeve Bearing, Bronze
PB-8125	1-1/4" Hardfaced Drill Bit
PB-8200	2" Hardfaced Drill Bit
PB-8300	3" Hardfaced Drill Bit
PB-8500	5" Hardfaced Reamer Bit
PB-8750	7-1/2" Hardfaced Reamer Bit



"THIN-LINE™" PLOWING BLADES

For Toro/Case/Astec, Vermeer LM25, LM35 & LM42, Burkeen B30*

Engineered for Performance

Thin-Line Plowing Blades offer outstanding quality, service life and flexibility at competitive prices. Their thin profile offers minimal turf disturbance while its replaceable carbide tipped reamer and heat treated alloy steel bushing insure substantially longer service life over standard blades. Two sets of mounting holes are machined into each blade to accommodate varying soil conditions and desired pull depth.

Part No.	Dimensions	Adjustable Plowing Depth	Mounting Shims (Pair)
TL-912-A	1/4" x 24"	9" and 12"	S-10-500
TL-912-B	3/8" x 24"	9" and 12"	S-10-437
TL-912-C	1/2" x 24"	9" and 12"	S-10-375
TL-1215-C	1/2" x 26 1/2"	12" and 15"	S-10-375
TL-1518-C	1/2" x 29 1/2"	15" and 18"	S-10-375

Two sets of mounting holes provide two plowing depths (Toro/Case & Vermeer plows only)

Optional Mounting Shims (Sold separately)

Replaceable, carbide tipped reamer for long life and easy bullet tracking - **Supplied with C-150**

B-200 Screw-in adapter for convenience and flexibility - (Sold separately)

B-100 or B-150 Bushing welded to blade

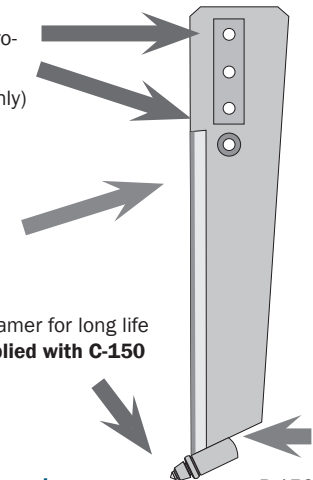

Note: when ordering any of the above blades for a Toro/Case P60 plow, you **must specify** such, since the mounting pad is thicker.

* The Burkeen plow design does not allow use of the adjustable plowing depth feature of Triple D blades. You can only use the top set of mounting holes.

"PULL" BLADES

For Toro RT600 & RT1200, Case 560 thru 860 (P85, P95 & P105 Plows)

Part No.	Description
VMT-24E	Maxi-Trac Plowing Blade - 18" Or 24" Plow Depth
VMT-24F	Maxi-Trac Plowing Blade - 18" Or 24" Plow Depth
VMT-30F	Maxi-Trac Plowing Blade - 24" Or 30" Plow Depth
VMT-36F	Maxi-Trac Plowing Blade - 30" Or 36" Plow Depth
VMT-42H	Maxi-Trac Plowing Blade - 36" Or 42" Plow Depth
VMT-48H	Maxi-Trac Plowing Blade - 42" Or 48" Plow Depth
VST-24E	Standard Pulling Blade - 18" Or 24" Plow Depth
VST-24F	Standard Pulling Blade - 18" Or 24" Plow Depth
VST-30F	Standard Pulling Blade - 24" Or 30" Plow Depth
VST-36F	Standard Pulling Blade - 30" Or 36" Plow Depth
VST-42H	Standard Pulling Blade - 36" Or 42" Plow Depth
VST-48H	Standard Pulling Blade - 42" Or 48" Plow Depth

Blade Thickness	
A - 1/4"	E - 3/4"
B - 3/8"	F - 1"
C - 1/2"	H - 1 1/2"
D - 5/8"	

Note: Hard Ground Toe & Rear Lug Are Standard Features

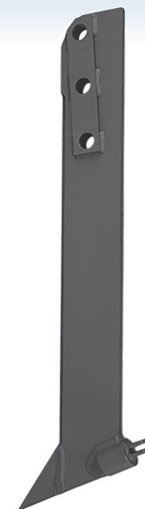



ENDURO PLOWING BLADES

For Toro Pro Sneak, Vermeer LM25, LM35 & LM42, Burkeen B30* (Case Mini & Maxi Sneakers)

Engineered for Performance

Enduro Plowing Blades provide contractors maximum performance and service at an economical price. Our replaceable carbide tipped reamer insures substantially longer service life over standard blades. In addition, each blade is provided with two or three sets of mounting holes to accommodate varying soil conditions and desired pull depth.

Enduro “Maxi-Trac”® Blades deliver maximum machine traction in difficult soil conditions by “pulling” the machine towards the ground. This additional traction provides faster plowing during adverse conditions.

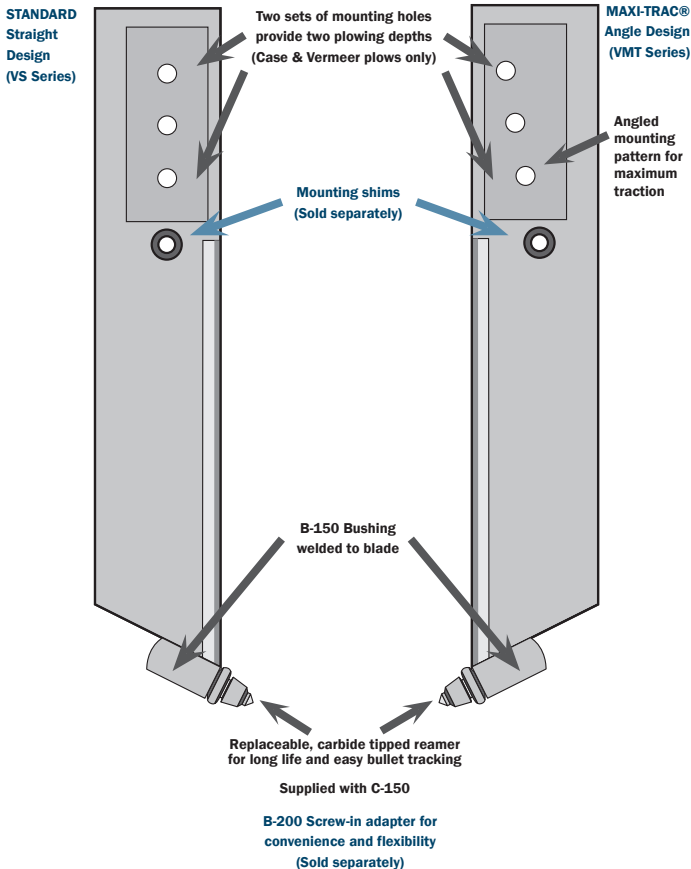

Custom sizes available upon request

Part No.	Blade Length	Average Plowing Depth	Mounting Shims (Pair)
VS-13 D	24"	10" or 13"	S-10-312
VS-16 D	27"	13" or 16"	S-10-312
VS-18 D	29"	15" or 18"	S-10-312
VS-24 D	35"	18", 21" or 24"	S-10-312
VS-13 E	24"	10" or 13"	S-10-250
VS-16 E	27"	13" or 16"	S-10-250
VS-18 E	29"	15" or 18"	S-10-250
VS-24 E	35"	18", 21" or 24"	S-10-250
VS-30 E	41"	24", 27" or 30"	S-10-250
VS-36 E	47"	30", 33" or 36"	S-10-250
VS-18 F	29"	15" or 18"	S-10-125
VS-24 F	35"	18", 21" or 24"	S-10-125
VS-30 F	41"	24", 27" or 30"	S-10-125
VS-36 F	47"	30", 33" or 36"	S-10-125
VMT-13 C	27"	10" or 13"	S-10-375
VMT-16 C	30"	13" or 16"	S-10-375
VMT-18 C	32"	15" or 18"	S-10-375
VMT-13 D	27"	10" or 13"	S-10-312
VMT-16 D	30"	13" or 16"	S-10-312
VMT-18 D	32"	15" or 18"	S-10-312
VMT-13 E	27"	15" or 18"	S-10-250

HARD GROUND TOE OPTIONS	
Part No.	Description
HGT-100X	HARD GROUND TOE OPTION W/REAR LUG
HGT-200X	HARD GROUND TOE OPTION W/REAR LUG & 2" BULLET
HGT-300X	HARD GROUND TOE OPTION W/REAR LUG & 3" BULLET

NOTE: Part No. suffix code indicates blade thickness.

Blade Thickness	
A - 1/4"	E - 3/4"
B - 3/8"	F - 1"
C - 1/2"	H - 1 1/2"
D - 5/8"	

* The Burkeen plow design does not allow use of the adjustable plowing depth feature of Triple D blades. You can only use the top set of mounting holes.



DELTA PLOWING BLADE

For Toro/Case/Astec, Vermeer LM25, LM35 & LM45, and Burkeen B30 Plows

Engineered for Performance

For exceptionally smooth plowing in turf, the new Delta blade is a premium series blade that plows with minimal lawn disturbance. Its new profile places the cutting edge in a near vertical position when cutting. This vertical cutting edge results in exceptionally smooth cutting of the turf and minimum heaving of the soil.

Only the finest materials and latest technology are used in manufacturing the Delta plowing blades.



Hard ground toe options

Quality high alloy steel.

Near vertical cutting edge when plowing - minimizes heaving and easily cuts small tree and shrub roots.

B-200 Screw-in adapter for convenience, flexibility and longevity - Sold separately.

B-150 bushing welded to blade

Replaceable Carbide tipped reamer for long life and easy bullet tracking - Supplied with C-150.

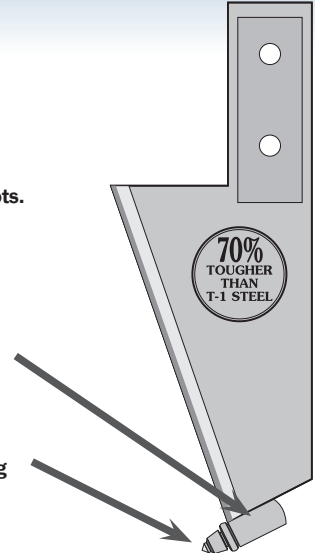

HARD GROUND TOE OPTIONS	
Part No.	Description
HGT-100X	HARD GROUND TOE OPTION W/REAR LUG
HGT-200X	HARD GROUND TOE OPTION W/REAR LUG & 2" BULLET
HGT-300X	HARD GROUND TOE OPTION W/REAR LUG & 3" BULLET

Part No.	Dimensions	Avg. Plowing Depth
D-8C	1/2" x 21"	8" Fixed
D-10C	1/2" x 23"	10" Fixed
D-12C	1/2" x 24"	12" Fixed

VALU-BLADE®

A new series of "basic quality" vibratory plowing blades designed for the budget oriented contractor. The VALU-BLADE is manufactured from quality Armor Tough Plate produced in the USA. Average tensile strength of this product is 100,000 psi.

Each blade is equipped with a one-piece, 1.5" diameter standard bullet and a rear lug for attachments. Other bullet diameters are available on an upgrade basis.



DITCH WICH®		
Part No.	Blade Thickness	Pull Depth
DWVB-10B	3/8"	10"
DWVB-12B	3/8"	12"

*Fits 255sx through 410sx

AVAILABLE BULLET SIZES	
Part No.	Diameter
BVB-150	1.5"
BVB-200	2.0"
BVB-200X	2.0" (Exchange)
BVB-250	2.5"
BVB-250X	2.5" (Exchange)

TORO/ASTEC/CASE, BURKEEM & VERMEER		
Part No.	Blade Thickness	Pull Depth
VB-912B	3/8"	9" or 12"

REPLACEMENT REAR LUG	
Part No.	
RL-100 (Requires Welding)	





TURF SHARK

Plow Through Roots, Turf and difficult soil with amazing ease

Engineered for Performance

With a new shark-like fin, Triple D's new **Turf Shark™** series plowing blades plow through small tree/shrub roots and difficult soil with amazing ease and neatness.

Our **Turf Shark™** blades are built to provide the contractor with the latest advances in plowing technology. They are tough and aggressive in all soil conditions... even in shale laden soil, thanks to their cutting edge and carbide tipped reamer. These features insure substantially longer service life over standard blades.

The new **Turf Shark™** delivers maximum performance and minimal turf disturbance... all at competitive pricing.



Hard ground toe options

HARD GROUND TOE OPTIONS	
Part No.	Description
HGT-100X	HARD GROUND TOE OPTION W/REAR LUG
HGT-200X	HARD GROUND TOE OPTION W/REAR LUG & 2" BULLET
HGT-300X	HARD GROUND TOE OPTION W/REAR LUG & 3" BULLET

TSDW Series

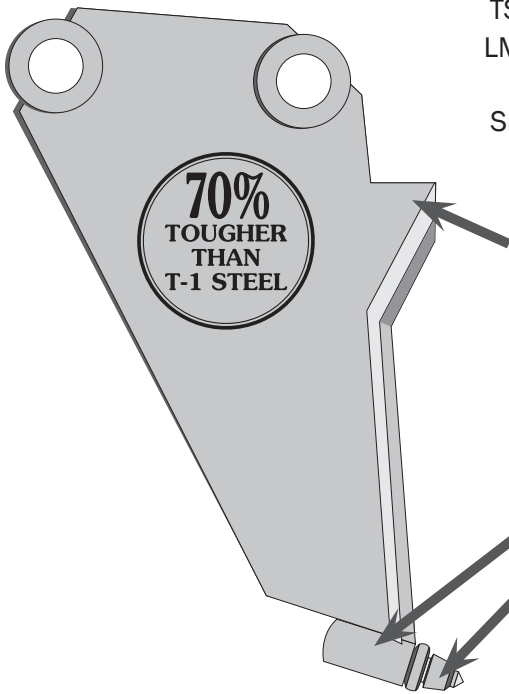

TS models fit Case/Astec, Vermeer LM25, LM35 & LM42, and Burkeen B30 Plows (Case Mini & Maxi Sneakers) TSDW's Fits Ditch Witch Models 255,350,400,410SX

New 45 degree cutter for smooth, clean turf and root cutting action

B-200 Screw-in adapter for convenience and flexibility
(sold separately)

B-150 Bushing welded to blade

Replaceable, carbide tipped reamer for long life and easy bullet tracking
(supplied with C-150)

TS Series

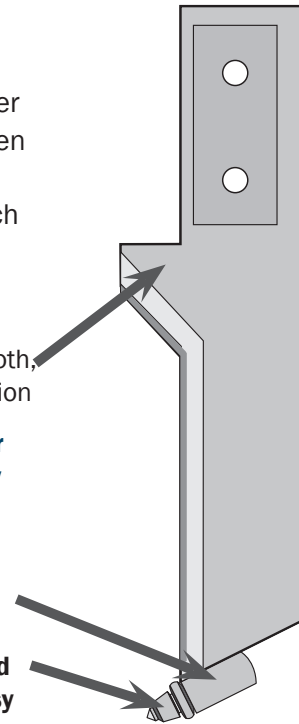

Note: For an additional charge, the Turf Shark™ (TS) feature can be added to any 1/2" or thicker plowing blade.

TSDW Series	
Part No.	Average Plowing Depth
TSDW-30-10C 1/2" x 18"	10" Fixed
TSDW-30-12C 1/2" x 20"	12" Fixed

TS Series	
Part No.	Average Plowing Depth
TS-10C 1/2" x 22"	10" Fixed
TS-10D 5/8" x 22"	10" Fixed
TS-12C 1/2" x 24"	12" Fixed
TS-12D 5/8" x 24"	12" Fixed



HIGH QUALITY PLOWING BLADES

For Ditch Witch Plows

DW100, VP12, VP252, 255SX, 350SX, 400SX, 410SX

Engineered for Performance

Part No.	Blade Length	Average Plowing Depth	Blade Thickness
DW 10-12 B	29"	Variable	3/8"
DW 20-10 C	25"	10"	1/2"
DW 20-12 C	27"	12"	1/2"
DW 30-10 C	18"	10"	1/2"
DW 30-12 C	20"	12"	1/2"
DW 30-15 C	23"	15"	1/2"
DW 30-18 C	26"	18"	1/2"
DW 30-12 D	20"	12"	5/8"
DW 30-18 D	26"	18"	5/8"
DW 30-24 D	32"	24"	5/8"
DW 30-12 E	20"	12"	3/4"
DW 30-18 E	26"	18"	3/4"
DW 30-24 E	32"	24"	3/4"
DW 30-30 E	38"	30"	3/4"
DW 30-24 F	32"	24"	1"
DW 30-30 F	38"	30"	1"

DW 20 Series

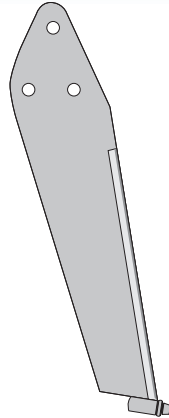

DW 10 Series

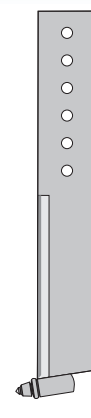

DW 30 Series

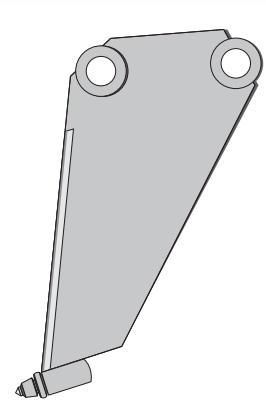

Replaceable, carbide tipped reamer for long life and easy bullet tracking
- Supplied with C-150

* B-200 screw-in adapter for convenience and flexibility
- Sold separately

HARD GROUND TOE OPTIONS

Part No.	Description
HGT-100X	HARD GROUND TOE OPTION W/REAR LUG
HGT-200X	HARD GROUND TOE OPTION W/REAR LUG & 2" BULLET
HGT-300X	HARD GROUND TOE OPTION W/REAR LUG & 3" BULLET

For Ditch Witch Model 420*



Part No.	Description
DW 40-912C	9" OR 12" PLOW DEPTH - 1/2" THICK
DW 40-1215C	12" OR 15" PLOW DEPTH - 1/2" THICK
DW 40-1518C	15" OR 18" PLOW DEPTH - 1/2" THICK
DW 40-912D	9" OR 12" PLOW DEPTH - 5/8" THICK
DW 40-1215D	12" OR 15" PLOW DEPTH - 5/8" THICK
DW 40-1518D	15" OR 18" PLOW DEPTH - 5/8" THICK
DW 40-2124D	21" OR 24" PLOW DEPTH - 5/8" THICK
DW 40-1215E	12" OR 15" PLOW DEPTH - 3/4" THICK
DW 40-1518E	15" OR 18" PLOW DEPTH - 3/4" THICK
DW 40-2124E	21" OR 24" PLOW DEPTH - 3/4" THICK
DW 40-2730E	27" OR 30" PLOW DEPTH - 3/4" THICK
DW 40-1518F	15" OR 18" PLOW DEPTH - 1.0" THICK
DW 40-2124F	21" OR 24" PLOW DEPTH - 1.0" THICK
DW 40-2730F	27" OR 30" PLOW DEPTH - 1.0" THICK
DW 40-3336F	33" OR 36" PLOW DEPTH - 1.0" THICK
DWB 40-2.5	UPGRADE TO 2.5" DIA., BULLET
DWB 40-3.0	UPGRADE TO 3.0" DIA., BULLET
DWB 40-3.5	UPGRADE TO 3.5" DIA., BULLET
DWB 40-4.0	UPGRADE TO 4.0" DIA., BULLET

* With 2" dia. Bullet, Lug & Hard Ground Toe as standard equipment.



“SABER CUT™” PLOWING BLADES

For Ditch Witch Plows 255SX Thru 410SX

Engineered for Performance

The ultra-thin and super tough SABER-CUT™ plowing system is engineered for outstanding performance and economy. It's ultra-thin profile make it the finest turf cutting plowing blade on the market today. It is the contractor's solution to minimal lawn disturbance at a very economical cost.

Saber-Cut's™ design concept centers around a heavy duty adapter plate and high quality, low cost disposable plowing blade. Saber-Cut™ blades are manufactured from premium heat treated abrasive resistant alloy steel - **they are 70% tougher than T1 steel.**

In addition, each Saber-Cut™ blade is supplied with Triple D's proprietary alloy steel bushing and carbide tipped reamer for longer service life.

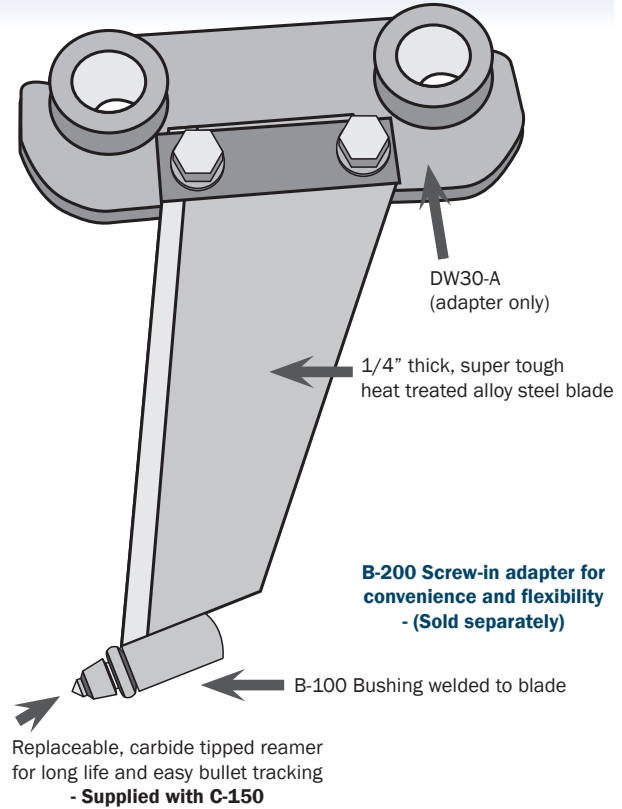

COMPLETE PLOWING ASSEMBLIES	
Part No.	Average Plowing Depth
DW30-A-8	8" Pull Depth
DW30-A-9	9" Pull Depth
DW30-A-10	10" Pull Depth
DW30-A-12	12" Pull Depth
DW30-A-14	14" Pull Depth

REPLACEMENT PARTS	
Part No.	Description
DW30-A	ADAPTER ONLY
SC-8	BLADE ONLY - 8"
SC-9	BLADE ONLY - 9"
SC-10	BLADE ONLY - 10"
SC-12	BLADE ONLY - 12"
SC-14	BLADE ONLY - 14"
DW30ACB	CLAMPING BAR
CS625175	CAP SCREW - EA.
LW625	LOCK WASHER - EA.
LN625	LOCK NUT - EA.

Warranty Disclaimer

“Saber Cut™” plowing blades are manufactured from the highest quality steel and have outstanding plowing performance under normal conditions. However, due to their thin cross section and underground use, they are not warranted against bending or breakage.



HARD-FACING OPTION

Double The Service Life Of Your New Plowing Blade

Tank Tough

Even though high quality abrasion resistant steel is used in the manufacture of all Triple D plowing blades, they eventually wear out from the abrasive action of plowing. There is however, an optional hard-facing process that can retard abrasion and extend blade service life. We can apply this optional process to your new plowing blade.

Using special hard-facing welding material, we apply a basket-weave pattern of weld to the bottom half of the plowing blade's sides. The basket-weave pattern is one of the best low-cost methods available that is used to extend blade service life. In addition to the hard-facing material itself protecting the blade, the basket-weave pattern captures and holds soil to the sides of the blade for additional protection from abrasion.

When selecting this hard-facing option, add 20% to the list price and the suffix "HF-1" to the blade model number (i.e. DW30-12C HF-1).



LONG LIFE

Blade Points With New Pin Fastening System

One (1) new size of carbide tipped blade reamer has been added to our product line - 2 1/2" dia. (.7 shank). They may be used on all Triple D plowing blades equipped with the B-150 bushing.

In addition to being carbide tipped, the flanges are banded with a heavy layer of hardfacing material for increased service life.

They may be ordered separately for field installation, or on an exchange basis when ordered installed on a new plowing blade, (see below).

LONG-LIFE BLADE REAMERS ALL WITH .760 SHANK	
Part No.	Description
C-150*	1.50" dia.
C-175HF	1.75" dia.
C-175HFX	1.75" dia. (exchange)
C-200HF	2.00" dia.
C-200HFX	2.00" dia. (exchange)
C-250HF	2.50" dia.
C-250HFX	2.50" dia. (exchange)
TC-150HF	1.50" Traction Point
TC-150HFX	150" Traction Point (exch.)
TC-200HF	2.00" Traction Point
TC-200HFX	2.00" Traction Point (exch.)
TC-250HFX	2.50" Traction Point

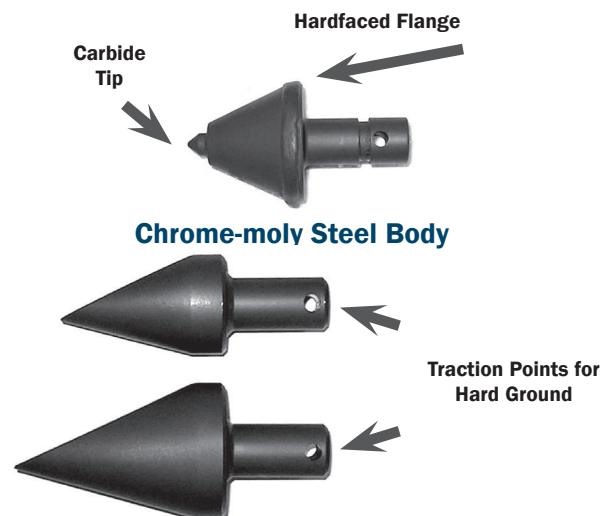

When ordered installed on an exchange basis, please use the suffix "X" in the item no. (i.e.: TC-200HFX).

SD BLADE BULLET SYSTEM

Triple D's new SD Blade Bullet System is the strongest, most durable and versatile in the industry. All major components, such as the bullet Receiver/Bushing and Bullets, are manufactured from heat-treated chrome-moly steel with an average tensile strength exceeding 150,000 psi for maximum strength and wear-resistance.

In addition to strength and durability, the SD System offers a large selection of bullet sizes, wear and design options to meet most soil and plowing conditions. Available bullet diameters are 2", 2.5", 3", 3.5" and 4". The Long-Life Bullet Series has a tungsten carbide tip and hard-facing for exceptional durability. All bullets have a **1" dia. shank**.

Traction Option

One of the more versatile options of the SD Bullet System is the "Traction Bullet" that is engineered to "pull down" the plowing blade and vibratory plow for increased traction and plowing depth in hard ground. In severe situations, the "XT Traction Bullet" is recommended for additional traction and pull depth.

The SD System, with a C-2000 bullet, is available as an "exchange" option on all 5/8" and thicker plow blades for an additional charge. Ask for option SD-1000X.

SD SYSTEM COMPONENTS ALL WITH 1" SHANK	
Part No.	Description
B-1750	BULLET RECEIVER/BUSHING
B-1750PS	PIN SET FOR B-1750 (2 PCS.)
C-2000	2.0" DIA. STD. BULLET
C-2500	2.5" DIA. STD. BULLET
C-2500X	2.5" DIA. STD. BULLET-EXCHANGE*
C-3000	3.0" DIA. STD. BULLET
C-3000X	3.0" DIA. STD. BULLET-EXCHANGE*
C-3500	3.5" DIA. STD. BULLET
C-3500X	3.5" DIA. STD. BULLET-EXCHANGE*
C-4000	4.0" DIA. STD. BULLET
C-4000X	4.0" DIA. STD. BULLET-EXCHANGE*
C-2000HF	2.0" DIA. LONG-LIFE BULLET
C-2000HFX	2.0" DIA. LONG-LIFE BULLET-EXCH.*
C-2500HF	2.5" DIA. LONG-LIFE BULLET
C-2500HFX	2.5" DIA. LONG-LIFE BULLET-EXCH.*
C-3000HF	3.0" DIA. LONG-LIFE BULLET
C-3000HFX	3.0" DIA. LONG-LIFE BULLET-EXCH.*
C-3500HF	3.5" DIA. LONG-LIFE BULLET
C-3500HFX	3.5" DIA. LONG-LIFE BULLET-EXCH.*
C-4000HF	4.0" DIA. LONG-LIFE BULLET
C-4000HFX	4.0" DIA. LONG-LIFE BULLET-EXCH.*
T-2500	STD. TRACTION BULLET
T-2500X	STD. TRACTION BULLET-EXCH.*
XT-2500	XT TRACTION BULLET ASSEMBLY
XT-2500X	XT TRACTION BULLET-EXCH.*
XT-1500	XT BULLET BODY
XT-2000	XT BULLET BOLT-ON POINT
XTCS-125	FLAT HEAD CAP SCREW, 1/2 X 1.25
XTCS-100	FLAT HEAD CAP SCREW, 1/2 X 1.00

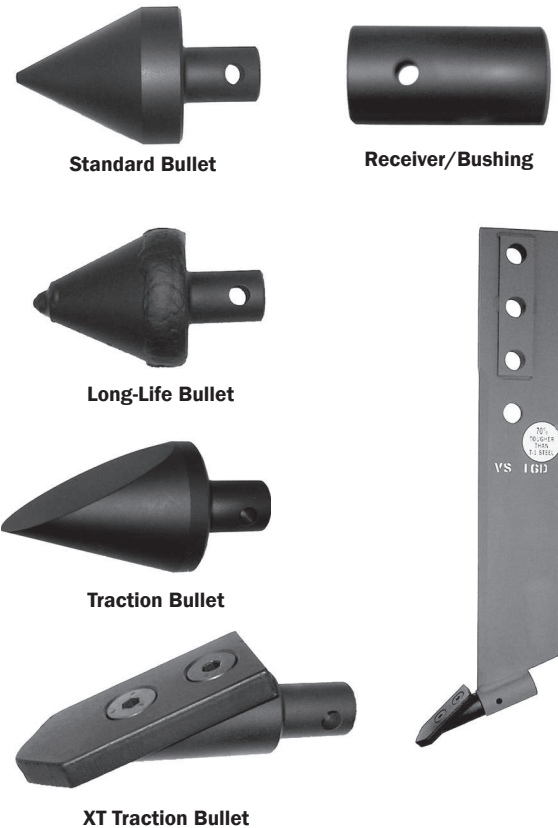

* EXCHANGE PRICE WHEN INSTALLED ON A "NEW" BLADE

REPLACEMENT LEADING EDGES

For Plow Blades

These "Leading Edges" are machined to a very sharp cutting edge from high quality alloy steel bar stock that is quenched and tempered for strength and durability. They are available with either a serrated or straight cutting edge, and in 1/2", 5/8", 3/4" and 1" thickness. Do not confuse these high quality leading edges with the blunt edged, sand-cast units that are on the market.

We are offering both styles of leading edges as replacement parts; and the serrated edge, can be factory installed on a "New" plow blade for as little as \$96.25. Both styles are of the "weld-on" type, and require fitting and welding with either a MIG or SMAW (stick) welding machine.

TOOL STEEL LEADING EDGES	
Part No.	Description
E-500	1/2" X 10" STANDARD EDGE
SE-500	1/2" X 10" SERRATED EDGE
SE-500X	1/2" X 10" SERRATED EDGE--FACTORY INSTALLED
E-625	5/8" X 10" STANDARD EDGE
SE-625	5/8" X 10" SERRATED EDGE
SE-625X	5/8" X 10" SERRATED EDGE--FACTORY INSTALLED
E-750	3/4" X 10" STANDARD EDGE
SE-750	3/4" X 10" SERRATED EDGE
SE-750X	3/4" X 10" SERRATED EDGE--FACTORY INSTALLED
E-1000	1.0" X 10" STANDARD EDGE
SE-1000	1.0" X 10" SERRATED EDGE
SE-1000X	1.0" X 10" SERRATED EDGE--FACTORY INSTALLED





ONE PIECE CHUTE BLADES

Small Radius / Large Radius

For Case/Toro P40 Plows, Burkeen B30* Vermeer LM25, LM35/40/42

NOTE: Always select a chute that is 1/16" wider than cable diameter.

SMALL RADIUS			
Standard Part No.	"Combo" Part No.	Cover Depth	Chute I.D.
CVS-12C	CCVS-12C	9" & 12"	1/2"
CVS-15C	CCVS-15C	12" & 15"	1/2"
CVS-18C	CCVS-18C	15" & 18"	1/2"
CVS-12E	CCVS-12E	9" & 12"	3/4"
CVS-15E	CCVS-15E	12" & 15"	3/4"
CVS-18E	CCVS-18E	15" & 18"	3/4"
CVS-12F	CCVS-12F	9" & 12"	1"
CVS-15F	CCVS-15F	12" & 15"	1"
CVS-18F	CCVS-18F	15" & 18"	1"

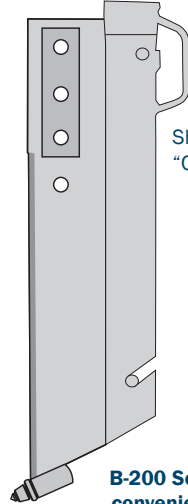

Shown as optional "Combo" Blade



HARD GROUND TOE OPTIONS	
Part No.	Description
HGT-100X	HARD GROUND TOE OPTION W/ REAR LUG
HGT-200X	HARD GROUND TOE OPTION W/ REAR LUG & 2" BULLET
HGT-300X	HARD GROUND TOE OPTION W/ REAR LUG & 3" BULLET

B-200 Screw-in adapter for convenience and flexibility Sold Separately

Other sizes available upon request. Chute widths up to 1" I.D.

LARGE RADIUS						
Part No.	Combo Part No.	Inside Chute Width	Depth of Ground Cover	Available Chute Radius		
				3"	5"	8"
C-75-912-3R	CC-75-912-3R	3/4"	9" OR 12"	Yes	Yes	N/A
C-75-1215-3R	CC-75-1215-3R	3/4"	12" OR 15"	Yes	Yes	Yes
C-75-1518-3R	CC-75-1518-3R	3/4"	15" OR 18"	Yes	Yes	Yes
C-75-1824-3R	CC-75-1824-3R	3/4"	18" OR 24"	Yes	Yes	Yes
C-75-2430-3R	CC-75-2430-3R	3/4"	24" OR 30"			
C-75-912-5R	CC-75-912-5R	3/4"	9" OR 12"			
C-75-1215-5R	CC-75-1215-5R	3/4"	12" OR 15"			
C-75-1518-5R	CC-75-1518-5R	3/4"	15" OR 18"			
C-75-1824-5R	CC-75-1824-5R	3/4"	18" OR 24"			
C-75-2430-5R	CC-75-2430-5R	3/4"	24" OR 30"			
C-75-1215-8R	CC-75-1215-8R	3/4"	12" OR 15"			
C-75-1518-8R	CC-75-1518-8R	3/4"	15" OR 18"			
C-75-1824-8R	CC-75-1824-8R	3/4"	18" OR 24"			
C-75-2430-8R	CC-75-2430-8R	3/4"	24" OR 30"			
C-75-3036-8R	CC-75-3036-8R	3/4"	30" OR 36"			
C-75-1824-10R	CC-75-1824-10R	3/4"	18" OR 24"			
C-75-2430-10R	CC-75-2430-10R	3/4"	24" OR 30"			
C-75-3036-10R	CC-75-3036-10R	3/4"	30" OR 36"			
C-75-1824-13R	CC-75-1824-13R	3/4"	18" OR 24"			
C-75-2430-13R	CC-75-2430-13R	3/4"	24" OR 30"			
C-75-3036-13R	CC-75-3036-13R	3/4"	30" OR 36"			

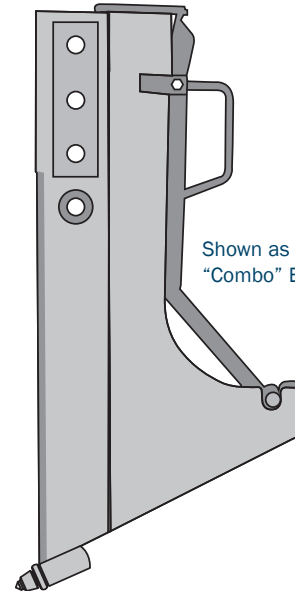

Shown as optional "Combo" Blade

B-200 Screw-in adapter for convenience and flexibility Sold Separately

Other sizes available upon request. Chute widths up to 2" I.D.

Notice
Chute blades are custom manufactured and are non-returnable. Therefore, please be certain of requirements prior to ordering.



ONE PIECE CHUTE BLADES

Small Radius / Large Radius

For Ditch Witch Plows 255SX, 350SX, 400SX, 410SX

NOTE: Always select a chute that is 1/16" wider than cable diameter.

SMALL RADIUS			
Standard Part No.	"Combo" Part No.	Cover Depth	Chute I.D.
CDW 20-12C	CCDW 20-12C	12"	1/2"
CDW 30-12C	CCDW 30-12C	12"	1/2"
CDW 30-15C	CCDW 30-15C	15"	1/2"
CDW 30-18C	CCDW 30-18C	18"	1/2"
CDW 30-12E	CCDW 30-12E	12"	3/4"
CDW 30-15E	CCDW 30-15E	15"	3/4"
CDW 30-18E	CCDW 30-18E	18"	3/4"
CDW 30-12F	CCDW 30-12F	12"	1.0"
CDW 30-15F	CCDW 30-15F	15"	1.0"
CDW 30-18F	CCDW 30-18F	18"	1.0"

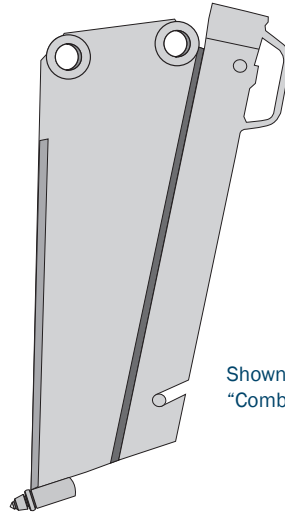

Shown as optional "Combo" Blade



HARD GROUND TOE OPTIONS	
Part No.	Description
HGT-100X	HARD GROUND TOE OPTION W/ REAR LUG
HGT-200X	HARD GROUND TOE OPTION W/ REAR LUG & 2" BULLET
HGT-300X	HARD GROUND TOE OPTION W/ REAR LUG & 3" BULLET

Other sizes available upon request.
Chute widths up to 1" I.D.

LARGE RADIUS				
Standard Part No.	"Combo" Part No.	Chute Radius	Cover Depth	Chute I.D.
CDW 30-12E-3R	CCDW 30-12E-3R	3"	12"	3/4"
CDW 30-18E-3R	CCDW 30-18E-3R	3"	15"	3/4"
CDW 30-24E-3R	CCDW 30-24E-3R	3"	18"	3/4"
CDW 30-30E-3R	CCDW 30-30E-3R	3"	12"	3/4"
CDW 30-15E-5R	CCDW 30-15E-5R	5"	15"	3/4"
CDW 30-18E-5R	CCDW 30-18E-5R	5"	18"	3/4"
CDW 30-24E-5R	CCDW 30-24E-5R	5"	24"	3/4"
CDW 30-30E-5R	CCDW 30-30E-5R	5"	30"	3/4"
CDW 30-15E-8R	CCDW 30-15E-8R	8"	15"	3/4"
CDW 30-18E-8R	CCDW 30-18E-8R	8"	18"	3/4"
CDW 30-24E-8R	CCDW 30-24E-8R	8"	24"	3/4"
CDW 30-30E-8R	CCDW 30-30E-8R	8"	30"	3/4"
CDW 30-18E-10R	CCDW 30-18E-10R	10"	18"	3/4"
CDW 30-24E-10R	CCDW 30-24E-10R	10"	24"	3/4"
CDW 30-30E-10R	CCDW 30-30E-10R	10"	30"	3/4"
CDW 30-18E-13R	CCDW 30-18E-13R	13"	18"	3/4"
CDW 30-24E-13R	CCDW 30-24E-13R	13"	24"	3/4"
CDW 30-30E-13R	CCDW 30-30E-13R	13"	30"	3/4"

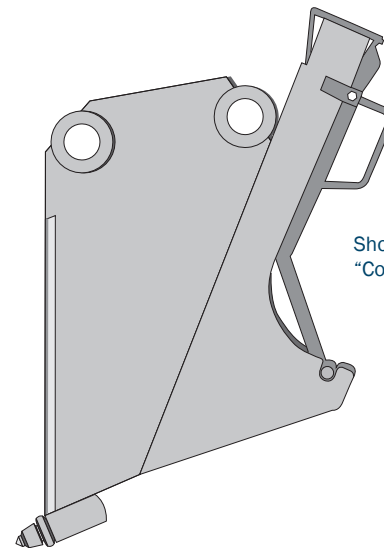

Shown as optional "Combo" Blade

B-200 Screw-in adapter for convenience and flexibility
Sold Separately

Other sizes available upon request.
Chute widths up to 2" I.D.

Notice
Chute blades are custom manufactured and are **non-returnable**. Therefore, please be certain of requirements prior to ordering.



MAXI-TRAC ONE PIECE CHUTE BLADE*

**For Toro RT600, RT1200, & Case 560 thru 860
(P85, P95 & P105) Plows**

Item No.	Description	Item No.	Description
CVMT-75-1824-8R-75	3/4" Chute Width - 18" Or 24" Ground Cover - 8" Radius	CVMT-10-3642-13R-150	1-1/2" Chute Width - 36" Or 42" Ground Cover - 13" Radius
CVMT-75-1824-10R-75	3/4" Chute Width - 18" Or 24" Ground Cover - 10" Radius	CVMT-10-1824-10R-200	2" Chute Width - 18" Or 24" Ground Cover - 10" Radius
CVMT-75-2430-8R-75	3/4" Chute Width - 24" Or 30" Ground Cover - 8" Radius	CVMT-10-1824-13R-200	2" Chute Width - 18" Or 24" Ground Cover - 13" Radius
CVMT-75-2430-10R-75	3/4" Chute Width - 24" Or 30" Ground Cover - 10" Radius	CVMT-10-2430-10R-200	2" Chute Width - 24" Or 30" Ground Cover - 10" Radius
CVMT-75-3036-8R-75	3/4" Chute Width - 30" Or 36" Ground Cover - 8" Radius	CVMT-10-2430-13R-200	2" Chute Width - 24" Or 30" Ground Cover - 13" Radius
CVMT-75-3036-10R-75	3/4" Chute Width - 30" Or 36" Ground Cover - 10" Radius	CVMT-10-3036-10R-200	2" Chute Width - 30" Or 36" Ground Cover - 10" Radius
CVMT-10-1824-8R-10	1" Chute Width - 18" Or 24" Ground Cover - 8" Radius	CVMT-10-3036-13R-200	2" Chute Width - 30" Or 36" Ground Cover - 13" Radius
CVMT-10-1824-10R-10	1" Chute Width - 18" Or 24" Ground Cover - 10" Radius	CVMT-10-3642-10R-200	2" Chute Width - 36" Or 42" Ground Cover - 10" Radius
CVMT-10-2430-8R-10	1" Chute Width - 24" Or 30" Ground Cover - 8" Radius	CVMT-10-3642-13R-200	2" Chute Width - 36" Or 42" Ground Cover - 13" Radius
CVMT-10-2430-10R-10	1" Chute Width - 24" Or 30" Ground Cover - 10" Radius	CVMT-10-2430-13R-250	2-1/2" Chute Width - 24" Or 30" Ground Cover - 13" Radius
CVMT-10-3036-8R-10	1" Chute Width - 30" Or 36" Ground Cover - 8" Radius	CVMT-10-2430-20R-250	2-1/2" Chute Width - 24" Or 30" Ground Cover - 20" Radius
CVMT-10-3036-10R-10	1" Chute Width - 30" Or 36" Ground Cover - 10" Radius	CVMT-10-3036-13R-250	2-1/2" Chute Width - 30" Or 36" Ground Cover - 13" Radius
CVMT-10-3036-13R-10	1" Chute Width - 30" Or 36" Ground Cover - 13" Radius	CVMT-10-3036-20R-250	2-1/2" Chute Width - 30" Or 36" Ground Cover - 20" Radius
CVMT-10-1824-8R-150	1-1/2" Chute Width - 18" Or 24" Ground Cover - 8" Radius	CVMT-15-3642-13R-250	2-1/2" Chute Width - 36" Or 42" Ground Cover - 13" Radius
CVMT-10-1824-10R-150	1-1/2" Chute Width - 18" Or 24" Ground Cover - 10" Radius	CVMT-15-3642-20R-250	2-1/2" Chute Width - 36" Or 42" Ground Cover - 20" Radius
CVMT-10-1824-13R-150	1-1/2" Chute Width - 18" Or 24" Ground Cover - 13" Radius	CVMT-15-3036-13R-300	3" Chute Width - 30" Or 36" Ground Cover - 13" Radius
CVMT-10-2430-8R-150	1-1/2" Chute Width - 24" Or 30" Ground Cover - 8" Radius	CVMT-15-3036-20R-300	3" Chute Width - 30" Or 36" Ground Cover - 20" Radius
CVMT-10-2430-10R-150	1-1/2" Chute Width - 24" Or 30" Ground Cover - 10" Radius	CVMT-15-3642-13R-300	3" Chute Width - 36" Or 42" Ground Cover - 13" Radius
CVMT-10-2430-13R-150	1-1/2" Chute Width - 24" Or 30" Ground Cover - 13" Radius	CVMT-15-3642-20R-300	3" Chute Width - 36" Or 42" Ground Cover - 20" Radius
CVMT-10-3036-8R-150	1-1/2" Chute Width - 30" Or 36" Ground Cover - 8" Radius	ADS-1	Additional Depth Setting
CVMT-10-3036-10R-150	1-1/2" Chute Width - 30" Or 36" Ground Cover - 10" Radius	TT-1	Tape Tube
CVMT-10-3036-13R-150	1-1/2" Chute Width - 30" Or 36" Ground Cover - 13" Radius	HF-1	Hard Facing Add-On
CVMT-10-3642-8R-150	1-1/2" Chute Width - 36" Or 42" Ground Cover - 8" Radius	RHGT-X	Replaceable Toe Option (Exchange)
CVMT-10-3642-10R-150	1-1/2" Chute Width - 36" Or 42" Ground Cover - 10" Radius		

*5° mounting hole pattern

Notice
Chute blades are custom manufactured and are **non-returnable**. Therefore, please be certain of requirements prior to ordering.



MAXI-TRAC CHUTE BLADES**

**For Toro RT600 & RT1200, & Case 560 thru 860
(P85, P95 & P105) Plows**

Item No.	Description	Item No.	Description
CVST-75-1824-8R-75	3/4" Chute Width - 18" Or 24" Ground Cover - 8" Radius	CVST-10-1824-10R-200	2" Chute Width - 18" Or 24" Ground Cover - 10" Radius
CVST-75-1824-10R-75	3/4" Chute Width - 18" Or 24" Ground Cover - 10" Radius	CVST-10-1824-13R-200	1-1/2" Chute Width - 36" Or 42" Ground Cover - 13" Radius
CVST-75-2430-8R-75	3/4" Chute Width - 24" Or 30" Ground Cover - 8" Radius	CVST-10-2430-10R-200	2" Chute Width - 18" Or 24" Ground Cover - 10" Radius
CVST-75-2430-10R-75	3/4" Chute Width - 24" Or 30" Ground Cover - 10" Radius	CVST-10-2430-13R-200	2" Chute Width - 18" Or 24" Ground Cover - 13" Radius
CVST-10-1824-8R-10	1" Chute Width - 18" Or 24" Ground Cover - 8" Radius	CVST-10-3036-10R-200	2" Chute Width - 24" Or 30" Ground Cover - 10" Radius
CVST-10-1824-10R-10	1" Chute Width - 18" Or 24" Ground Cover - 10" Radius	CVST-10-3036-13R-200	2" Chute Width - 24" Or 30" Ground Cover - 13" Radius
CVST-10-2430-8R-10	1" Chute Width - 24" Or 30" Ground Cover - 8" Radius	CVST-10-3642-10R-200	2" Chute Width - 30" Or 36" Ground Cover - 10" Radius
CVST-10-2430-10R-10	1" Chute Width - 24" Or 30" Ground Cover - 10" Radius	CVST-10-3642-13R-200	2" Chute Width - 30" Or 36" Ground Cover - 13" Radius
CVST-10-3036-8R-10	1" Chute Width - 30" Or 36" Ground Cover - 8" Radius	CVST-10-2430-13R-250	2" Chute Width - 36" Or 42" Ground Cover - 10" Radius
CVST-10-3036-10R-10	1" Chute Width - 30" Or 36" Ground Cover - 10" Radius	CVST-10-2430-20R-250	2" Chute Width - 36" Or 42" Ground Cover - 13" Radius
CVST-10-3036-13R-10	1" Chute Width - 30" Or 36" Ground Cover - 13" Radius	CVST-10-3036-13R-250	2-1/2" Chute Width - 24" Or 30" Ground Cover - 13" Radius
CVST-10-1824-8R-150	1-1/2" Chute Width - 18" Or 24" Ground Cover - 8" Radius	CVST-10-3036-20R-250	2-1/2" Chute Width - 24" Or 30" Ground Cover - 20" Radius
CVST-10-1824-10R-150	1-1/2" Chute Width - 18" Or 24" Ground Cover - 10" Radius	CVST-15-3642-13R-250	2-1/2" Chute Width - 30" Or 36" Ground Cover - 13" Radius
CVST-10-1824-13R-150	1-1/2" Chute Width - 18" Or 24" Ground Cover - 13" Radius	CVST-15-3642-20R-250	2-1/2" Chute Width - 30" Or 36" Ground Cover - 20" Radius
CVST-10-2430-8R-150	1-1/2" Chute Width - 24" Or 30" Ground Cover - 8" Radius	CVST-15-3036-13R-300	2-1/2" Chute Width - 36" Or 42" Ground Cover - 13" Radius
CVST-10-2430-10R-150	1-1/2" Chute Width - 24" Or 30" Ground Cover - 10" Radius	CVST-15-3036-20R-300	2-1/2" Chute Width - 36" Or 42" Ground Cover - 20" Radius
CVST-10-2430-13R-150	1-1/2" Chute Width - 24" Or 30" Ground Cover - 13" Radius	CVST-15-3642-13R-300	3" Chute Width - 30" Or 36" Ground Cover - 13" Radius
CVST-10-3036-8R-150	1-1/2" Chute Width - 30" Or 36" Ground Cover - 8" Radius	CVST-15-3642-20R-300	3" Chute Width - 30" Or 36" Ground Cover - 20" Radius
CVST-10-3036-10R-150	1-1/2" Chute Width - 30" Or 36" Ground Cover - 10" Radius	ADS-1	Additional Depth Setting
CVST-10-3036-13R-150	1-1/2" Chute Width - 30" Or 36" Ground Cover - 13" Radius	TT-1	Tape Tube
CVST-10-3642-8R-150	1-1/2" Chute Width - 36" Or 42" Ground Cover - 8" Radius	HF-1	Hard Facing Add-On
CVST-10-3642-10R-150	1-1/2" Chute Width - 36" Or 42" Ground Cover - 10" Radius	RHGT-X	Replaceable Toe Option (Exchange)
CVST-10-3642-13R-150	1-1/2" Chute Width - 36" Or 42" Ground Cover - 13" Radius		

** Parallel mounting hole pattern.

Notice
Chute blades are custom manufactured and are **non-returnable**. Therefore, please be certain of requirements prior to ordering.



TRACTION BLADE

**For Toro Pro Sneak,
Vermeer LM25, 35, 40 & 42, Burkeen B30
(Case Mini & Maxi Sneakers)**

Engineered and Manufactured for Hard, Difficult Soils

We believe our Traction Blade is the most advanced and durable “hard ground” plowing blade on the market today. The blades massive bottom assembly, with its replaceable and indexable “toe”, not only pulls the vibratory plow towards the ground for greater traction, but also maintains desired burial depth.

Each blade is equipped with a heavy duty point style toe (TR-2) and a 2” diameter threaded bullet as standard equipment. A chisel style toe and larger diameter bullets are available at additional cost.

TR SERIES



CASE. BURKEEN, VERMEER

Blade Part No.	Plowing Depth
TR-12E	9” or 12”
TR-15E	12” or 15”
TR-18E	15” or 18”
TR-24E	18” or 24”

* ALL BLADES ARE 3/4” THICK

OPTIONAL BLADE BULLETS

Bullet Part No.	Diameter
TRB-25X	2.5”
TRB-30X	3.0”
TRB-20	2.0”
TRB-25	2.5”
TRB-30	3.0”

TRDW SERIES



DITCHWITCH

Blade Part No.	Plowing Depth
TRDW-12E	12”
TRDW-15E	15”
TRDW-18E	18”
TRDW-24E	24”

* ALL BLADES ARE 3/4” THICK

BLADE TOES & HARDWARE

Bullet Part No.	Description
TR-1	CHISEL EDGE TOE
TR-2	POINTED TOE
TRCS-25	FRONT CAP SCREW
TRCS-30	REAR CAP SCREW
TRLN-05	LOCK NUT



AUSSIE

Pulling & One Piece Chute Blades For The Dingo

Pulling Blades		
Part No.	Max. Pull Depth	Blade Thickness
DG-12A	12"	1/4"
DG-12B	12"	3/8"
DG-12C	12"	1/2"
DG-15C	15"	1/2"
DG-18C	18"	1/2"

One Piece Chute Blades			
Part No.	"Combo" Part No.	Max. Cover Depth	Chute I.D.
CDG-12C	CCDG-12C	12"	1/2"
CDG-18C	CCDG-18C	18"	1/2"

HARD GROUND TOE OPTIONS	
Part No.	Description
HGT-100X	HARD GROUND TOE OPTION W/REAR LUG
HGT-200X	HARD GROUND TOE OPTION W/REAR LUG & 2" BULLET
HGT-300X	HARD GROUND TOE OPTION W/REAR LUG & 3" BULLET

Pulling Blades

One Piece Chute Blades



B-200 Screw-in adapter for convenience and flexibility - Sold Separately



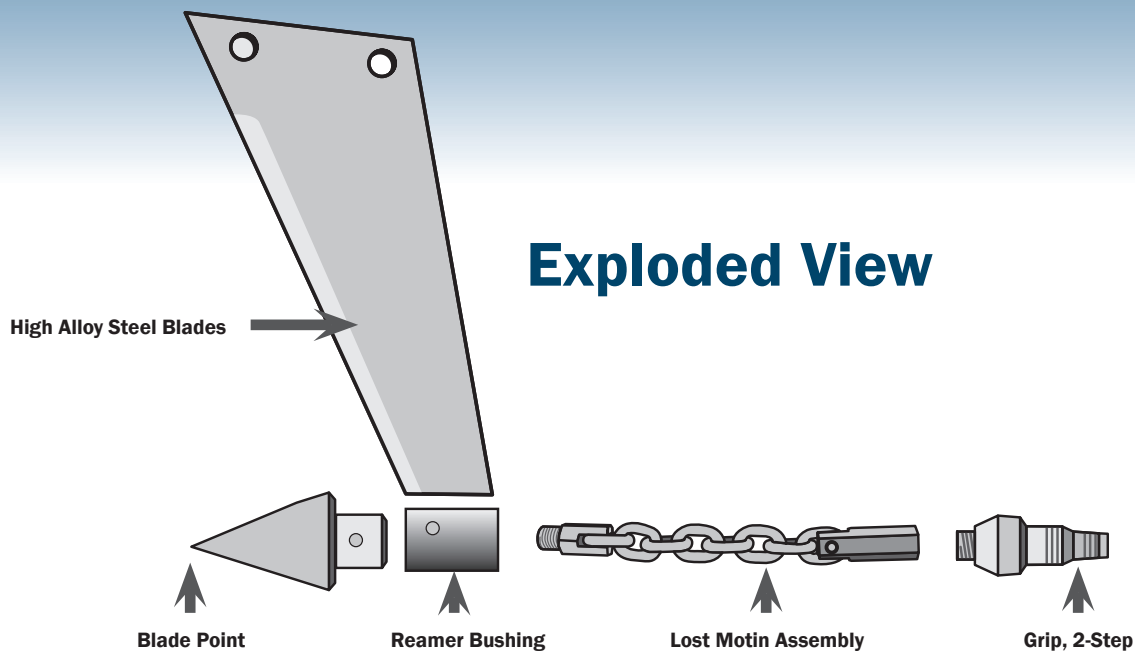

PIPE PIPER PLOWING SYSTEM



Exploded View

PIPE PIPER AND KAERCHER

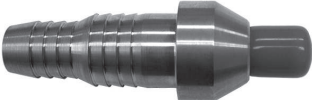
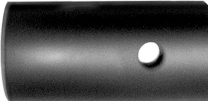
Product Listing

Part	Part No.	Description	Fits	
Plowing Blades				
	T1-12	SMALL BLADE - 12" O.A.L.	MACHINE MODEL 100	
	T1-13	SMALL BLADE - 13" O.A.L.		
	T2-10	LG. BLADE - 10" O.A.L. - LG. BUSHING		
	T2-12	LG. BLADE - 12" O.A.L. - LG. BUSHING	Kaercher 256 140/175 180/230	
	T2-14	LG. BLADE - 14" O.A.L. - LG. BUSHING		
	T2-15	LG. BLADE - 15" O.A.L. - LG. BUSHING		
	T2-17	LG. BLADE - 17" O.A.L. - LG. BUSHING		
	T2-11A	LG. BLADE - 11" O.A.L. - SM. BUSHING		
	T2-13A	LG. BLADE - 13" O.A.L. - SM. BUSHING	Kaercher 256 140/175 180/230	
	T2-14A	LG. BLADE - 14" O.A.L. - SM. BUSHING		
	T2-16A	LG. BLADE - 16" O.A.L. - SM. BUSHING		
	T2-15RC	LG. BLADE - 15" O.A.L. - ROOT CUTTER		
	K2-14	9" PULL DEPTH	Kaercher Style Plowing Blades for Kaercher and Pipe Piper Plows	
	K2-15	10" PULL DEPTH		
	K2-17	12" PULL DEPTH		
Blade Points				
	TP-100	SMALL POINT - 1.5" O.D.	SM. BUSH.	
	TP-100P	SMALL POINT PIN (1 pc.)	SM. BUSH.	
	TP-200	LARGE POINT - 2.25" O.D.	} Also Fits Kaercher	LG. BUSH.
	TP-250	LARGE POINT - 2.50" O.D.		LG. BUSH.
	TP-200P	LARGE POINT PIN (1 pc.)		LG. BUSH.
Pipe Grips				
	TG-2X	GRIP, 2-STEP - 3/4" AND 1" PIPE	ALL	
	TG-3X	GRIP, 3-STEP - 3/4" THRU 1 1/4" PIPE	ALL	
	TG-4X	GRIP, 4-STEP - 3/4" THRU 1 1/2" PIPE	ALL	
Blade Bushings				
	TB-100	BUSHING, SMALL	ALL BLADES	
	TB-200	BUSHING, LARGE - Also Fits Kaercher	LG. BLADES	
Adapters				
		5/8" THREAD	ALL BLADES	
	TA-1	LOST MOTION ASSEMBLY SET		
	TA-1K	LOST MOTION ASSEMBLY		
	TA-1D	LOST MOTION ASSEMBLY - 5/8" MALE x 3/4" MALE		
	TA-1M	ADAPTER, MALE		
	TA-1F	ADAPTER, FEMALE		
	TA-1C	ADAPTER, CHAIN (HI-TEST)		
	TA-1PS	ADAPTER PIN SET (2 pcs.)		
	TCS-5250	CAP SCREW, 1/2" X 2.5" (Grade 8)		
	TCS-6350	CAP SCREW, 5/8" X 3.5" (Grade 8)		
	TLN-50	LOCK NUT, 1/2" (Grade 8)		
	TLN-60	LOCK NUT, 5/8" (Grade 8)		

NOTE: All manufacturer's names, symbols, and descriptions are used for reference purposes only, and none of the products listed are the products of these manufacturers.

MAXIGRIP®

Pull Underground Pipe and Cable Quickly and Easily With “Maxi-Grip”® Pipe and Cable Pullers

So Unique They Earned U.S. Patent No. 4,969,677

Triple D’s Maxi-Grips are durable and economical tools designed for pulling underground pipe and cable with speed and ease. Maxi-Grips consist of two primary components - a uniquely designed steel nose cone device and a heavy duty plastic coated galvanized steel mesh grip. Six models enable contractors to pull pipe and cable from 1/2 inch to 4 1/2 inch outside diameters.

Provides the contractor with greater flexibility, convenience, and durability!

Unique nose cone design provides the user with several economic and time saving benefits not found in any other pulling device on the market today. First, each Maxi-Grip accommodates multiple sizes of pipe and cable, thereby minimizing contractor tooling costs.

Second, the tapered nose cone provides a large, smooth compacted boring for pipe and cable to follow, thus reducing friction and allowing longer pulls. Also, the large boring eliminates cable “looping” when boring under walkways and driveways. Third, the nose cone design eliminates the need to seal pipe opening against outside contamination. The user merely slips the pipe into the nose cone and pulls the pipe - a real time saver. Fourth, since the mesh grips are mounted inside the nose cone, they last up to five times longer.

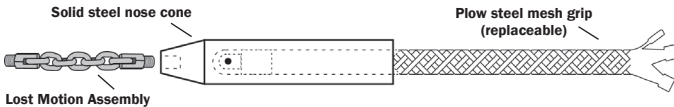

PIPE AND CABLE ARE EASILY INSERTED - QUICKLY REMOVED

“MAXI-GRIP”® PIPE AND CABLE PULLERS



MAXI-GRIP W/O MESH GRIP	
Part No.	O.D.
MG 100Z	1.875"
MG 125Z	2.375"
MG 200Z	3.000"
*MG 300Z	4.500"
*MG 400Z	5.500"

MAXI-GRIP WITH MESH GRIP			REPLACEMENT MESH GRIPS	SPRING PIN SET (2PCS.)	WORKING LOAD LBS.	BREAKING STRENGTH LBS.
Part No.	PIPE SIZE	GRIP RANGE	Part No.	Part No.		
MG-100A 1.875" O.D.	1/2" - 3/4"	.75" - 1.25"	A-20	SP-100	2,000	6,000
MG-100B 1.875" O.D.	3/4" - 1"	1.050" - 1.400"	B-24	SP-100	2,500	7,500
MG-125A 2.375" O.D.	3/4" - 1 1/4"	1.050" - 1.800"	B-24	SP-125	2,500	7,500
MG-200A 3.0" O.D.	1 1/2" - 2"	1.75" - 2.375"	C-26	SP-200	3500	10,500
MG-300E* 4.5" O.D.	2 1/2" - 3"	2.75" - 3.5"	D-38	SCS-4 (bolt)	4,500	13,500
MG-400E* 5.5" O.D.	3 1/2" - 4"	4.0" - 4.5"	F-52	SCS-5 (bolt)	6,000	18,000

* Equipped With Welded, Forged Eye in Place

SWIVEL EYE GRIPS

Constructed with a solid steel rotating eye and high grade galvanized cable, Triple D's Swivel Eye Grips provide contractors with a strong, long wearing grip that is easy to load and unload. These grips are engineered for pulling underground pipe, duct and primary and secondary cables.

The rotating eye is not a ball bearing type swivel and will not turn under pulling tension. It will only turn to relieve pulling torque when the pulling tension is released. If a constant swivel action is needed during a pull, use a properly sized ball bearing swivel ahead of the grip.

SWIVEL EYE MESH GRIPS					
Part No.	Weave	Grip Range*	Mesh Lth.	Working Load	Tensile Strength
S 75-99	DOUBLE	.75-.99	20"	2,200	6,800
S 100-124	DOUBLE	1.00-1.24	20"	4,400	12,800
S 125-149	DOUBLE	1.25-1.49	24"	4,400	12,800
S 150-199	DOUBLE	1.50-1.99	25"	5,500	16,400
S 200-249	DOUBLE	2.00-2.49	26"	9,000	27,200
S 250-299	DOUBLE	2.50-2.99	28"	11,000	33,000
S 300-349	DOUBLE	3.00-3.49	30"	13,600	41,000
S 350-399	DOUBLE	3.50-3.99	32"	16,000	48,000
S 400-449	DOUBLE	4.00-4.49	33"	16,000	48,000



PULLING GRIPS

Pulling grips are fabricated of Hi-Fatigue Aircraft Strand plastic coated steel cable. Continuous fabrication of grip from receiving end through entire mesh - including eye - provides a flexible stress relieving pulling eye. All strands are plastic coated, which increases the life of the grip, provides a bearing surface on underground pulls, and increases the ease and safety of installation and removal for workmen.

Part No.	Nominal Grip Range*		Working Load
A20-SW	3/4" - 1 1/4"	(Single Weave)	1,000#
A20	3/4" - 1 1/4"	(Double Weave)	2,000#
B24	1 1/4" - 2"	(Triple Weave)	2,500#
C26	2" - 2 3/4"	(Triple Weave)	3,500#
D38	2 3/4" - 3 1/2"	(Triple Weave)	4,500#
E46	3 1/2" - 4 1/4"	(Triple Weave)	5,500#
F52	4 1/4" - 4 7/8"	(Triple Weave)	6,000#

*Without Maxi-Grip Nose-Cone

NOTE: When used without a "Lost Motion" device and trailing bullet, service life is significantly reduced.



POLY CHAIN GRIP

Designed for the “Loop” gripping method of pulling poly pipe. Four bullet diameters are available to give the contractor flexibility in pulling 1/2 inch thru 2 inch poly pipe. The poly chain grip is also ideal for pulling multiple poly pipes simultaneously.

POLY CHAIN GRIP ASSEMBLY		REPLACEMENT PARTS	
Part No.	O.D.	Pin Set	Chain
PCG-150	1.5"	SP-75	CH-2050
PCG-200	2"	SP-100	CH-2050
PCG-250	2.5"	SP-125	CH-2050
PCG-300	3"	SP-200	CH-3000
CH-2050	Replacement Chain For PCG-200 & PCG-250		
CH-3000	Replacement Chain For PCG-300		

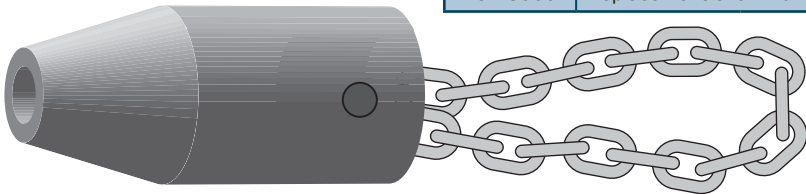

Use a “Lost Motion Assembly” to attach the chain grip to any TRIPLE D plowing blade.

TRAILING BULLETS

Five bullet diameters are available to give the contractor flexibility in pulling pipe and cable. Trailing bullets are also ideal for pulling multiple pipes and cables simultaneously.

Part No.	O.D.	Replacement Pin Set No.
BLT-150	1.5"	SP-75
BLT-200	2"	SP-100
BLT-250	2.5"	SP-125
BLT-300	3"	SP-200
BLT-400	4"	SP-300

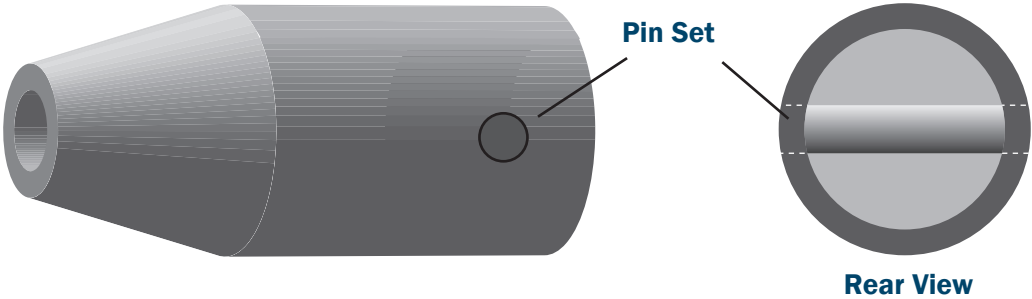

Use a “Lost Motion Assembly” to attach trailing bullets to any TRIPLE D plowing blade.

WEDGE-GRIP

Pipe and Duct Grip

Triple D's new WEDGE-GRIP Pipe and Duct Grip is designed for pipe pulling (including vibratory plowing) and boring pull-backs. Its extreme ease of use, broad gripping range and rugged design make it an ideal grip for underground contractors. Coupling and uncoupling to pipe and duct can be done in just a few seconds without tools.

The WEDGE-GRIP'S sleeve has a different bore size at each end that allows it to grip a broad range of both PVC and PE pipe. It will grip 1" irrigation pipe SDR-11.5 and SDR-15, 1" PVC pressure pipe SDR-21 and SCH-40, 1" yellow gas pipe SDR-11, 1" O.D. controlled innerduct SDR-11, 13.5, 15.5 and 40, and 1" I.D. controlled innerduct SDR-9 and 11.5.

The grip's cone-shaped end cover reduces snagging, provides a smooth bore hole and, most importantly, keeps dirt out of the pipe. Additional protection from dirt is provided by a secondary shield – the sleeve's 1/2" thick web.

Once you have evaluated the WEDGE-GRIP'S many features, we believe you will agree it offers more value and flexibility than any other wedge-type pipe grip on the market today.

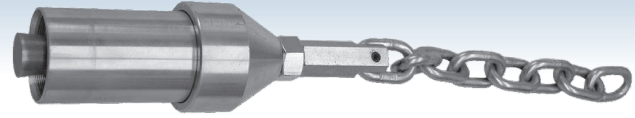

Part No.	Description
WL-0100	WEDGE-GRIP with TA-1K - COMPLETE ASSEMBLY for 1" Pipe
WL-0125	WEDGE-GRIP with TA-1K - COMPLETE ASSEMBLY for 1 1/4" Pipe
WL-0100-A	Shaft with Cone – Chrome-moly Steel
WL-0125-A	Shaft with Cone – Chrome-moly Steel
WL-0100-B	Tapered End Cap (Nose Cone)
WL-0125-B	Tapered End Cap (Nose Cone)
WL-0100-C	Shell, Multi-Grip
WL-0125-C	Shell, Multi-Grip
WL-0100-D	Internal Grip Kit with "O" Rings
WL-0125-D	Internal Grip Kit with "O" Rings
WL-0100-E	Shaft Nut – 5/8" x 18 (Stainless Steel) Fits all WEDGE-GRIPS

LMA-700

H.D. Lost Motion Assembly

The LMA-700 is a heavy-duty lost motion assembly engineered for 100% greater strength and service life over the standard TA-I K lost motion assembly. It is manufactured from 1" hex steel bar stock and 5/16" heat treated chain, making it the ideal choice for use with the WEDGE-GRIP Pipe and Duct Grip.

Part No.	Description
LMA-700	H.D. Female adapter with H.D. Chain
LMA-700X	Exchange Price With WL-0100
TA-2F	Heavy Duty Female Adapter - 1" Hex
TA-2C	Heavy Duty Chain for TA-2F



LOST MOTION ASSEMBLIES

Used To Connect Pipe And Cable Gripping Devices To Plowing Blades

Provides an easy and positive connection between Triple D plowing blades and various pipe and cable pulling devices. They also extend the life expectancy of pulling devices by isolating them from the reciprocating motion of the plowing blade. There are eight (8) lost motion assemblies to choose from.

LMA-100 - A general purpose lost motion assembly for all other pulling device and blade combinations



LMA-150 - Connects Poly Pipe Grips (TG-2X thru TG-4X) and King Grips to Triple D plowing blades



LMA-200 - Connects Maxi-Grips (MG-100A thru MG-200A), all Poly Chain Grips, and Trailing Bullets (BLT-200 thru BLT-300) to Triple D plowing blades



4. **LMA-500** - A H.D. Lost Motion Assembly - 3/8" Chain x 1 1/4" Hex.



5. **LMA-600** - A H.D. Lost Motion Assembly - 3/8" Chain x 1 1/4" Hex.



6. **TA-1** - Connects Poly Pipe Grips (TG-2X thru TG-4X) and King Grips to Pipe Piper plowing blades



7. **TA-1K** - Connects Poly Pipe Grips (TG-2X thru TG-4X) and King Grips to Kaercher plowing blades



8. **TA-1D** - Connects Triple D Bullets & Grips to Pipe Piper Plowing Blades.



SWIVEL-EYE MAXI-GRIPS

Triple D's **Swivel-Eye Maxi-Grips** are designed to help relieve the twisting forces that are created when pulling pipe and cable underground. Today, they are being used extensively in the Directional Boring Industry to relieve destructive pulling torque on pipe and cable.

All Swivel-eye assemblies are custom manufactured by Triple D from Forged Carbon and Alloy Steels that are Heat-Treated to ASTM Standards for strength and wear resistance.

Swivel-Eye assemblies are attached to Maxi-Grips, both mechanically by thread and MIG welding, to insure maximum tensile strength and service life.

NOTICE: **Do not** push rearward when directional boring. You may crush pulling eye.

SWIVEL-EYE MAXI GRIPS with MESH GRIP	
Part No.	Pipe Size
MG-100AS	1/2" - 3/4"
MG-100BS	3/4" - 1"
MG-125AS	3/4" - 1 1/4"
MG-200AS	1 1/2" - 2"
MG-300ES	2 1/2" - 3"
MG-400ES	3 1/2" - 4"



FIXED HEAD PE PIPE & INNERDUCT PULLING EYES

These solid steel pullers are machined with a tapered buttress thread to grip the inside wall of polyethylene pipe and innerduct by simply screwing them into the opening. When properly installed, the gripping power of the puller is stronger than the tensile strength of the pipe or innerduct. Pullers are installed quickly and easily with a screwdriver shaft or metal rod.

Typical uses are:

1. Pulling polyethylene water pipe, gas pipe and cable ducting with a vibratory plow.
2. Installing innerduct inside large cable duct.
3. Installing pipe and ducting in Horizontal and Directional Drilling applications.

DP-125L Shown

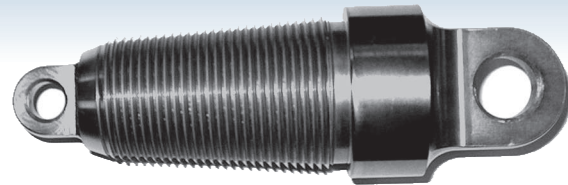

LUG STYLE PULLING EYES			
Part No. With Rear Lug I.D.	Nominal Duct Size	Min I.D.	MAX I.D.
DP-075L	3/4"	0.72"	0.93"
DP-100L	1"	0.94"	1.15"
DP-100AL	1" IRRIGATION PIPE-SDR 21		
DP-125L	1-1/4"	1.26"	1.44"
DP-150L	1-1/2"	1.48"	1.66"
DP-175L	1-3/4"	1.65"	1.85"
DP-200L	2"	1.91"	2.08"
DP-300L	3"	2.5"	3.125"

SOIL PROBES

Noninsulated

These soil probes use a high strength chrome-moly steel shaft for rigidity and durability.

The handle, shaft and tip are threaded. This allows the contractor to replace shafts and tips as required.

All probe tips are manufactured from heat treated alloy steel and designed to provide a clearance hole for the shaft. This makes penetration and withdrawal of the probe easier since the shaft is not dragging against the soil.

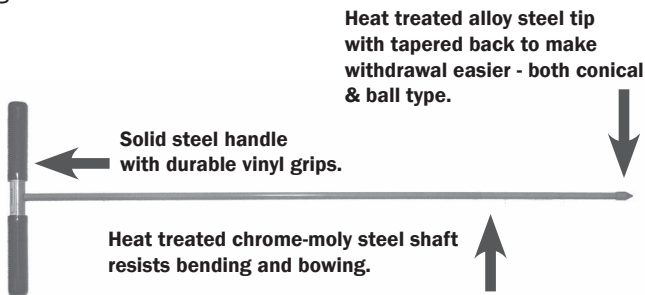

COMPLETE UNIT W/HANDLE, SHAFT, & CONICAL TIP	
Part No.	Length
SP-36	36 IN.
SP-42	42 IN.
SP-48	48 IN.
SP-54	54 IN.

CHROME-MOLY SHAFTS	
Part No.	Length
SPS-36	36 IN.
SPS-42	42 IN.
SPS-48	48 IN.
SPS-54	54 IN.

TIPS - CONICAL	
Part No.	Quantity
SP-5	5 PACK
SP-10	10 PACK

TIPS - BALL	
Part No.	Quantity
SPTB-5	5 PACK
SPTB-10	10 PACK

NOTE:

Shipped KD to reduce shipping and handling costs.

Insulated

Terra-Bore's insulated alloy steel soil probe is designed to provide electrical protection up to **45,000 volts** - provided the user avoids bodily contact with the un-insulated portion of the probe (the shaft). Other quality features of our insulated soil probe are:

1. Probe **TIP** is heat treated chrome-moly alloy steel for durability, and is threaded for easy replacement
2. Probe **SHAFT** is heat treated chrome-moly alloy steel for resistance to bending and is threaded on each end for a secure connection and ease of replacement *(will not snap in half like a fiberglass shaft).
3. Probe **INSULATOR** is manufactured by using Advanced Ram Extrusion Technology to achieve high tensile and yield strengths. The insulator is then precision machined to finished dimensions on state-of-the-art CNC machinery. Insulator is also impervious to water absorption for constant dielectric strength.
4. Probe **HANDLE** is 7/8" x 11" solid steel for strength and control during ground penetration.
5. Probe **GRIPS** are durable and comfortable vinyl for impact resistance.

The Insulated Probe is readily available in 36", 42", 48" and 54" lengths. Other lengths are available upon request.



PROBES	
Part No.	Handle Length
ISP 36	7/8" x 11", 36"
ISP-42	7/8" x 11", 42"
ISP-48	7/8" x 11", 48"
ISP-54	7/8" x 11", 54"

*Dielectric Strength Tested To ASTM D-149

SIDEWALK SPEAR

Triple D has developed a new and inexpensive tool kit to install 1" pipe, short distances, under sidewalks and similar obstacles. The tool kit contains two parts - a "Striking Head" and a "Compaction Point" that screw onto a customer supplied length of 1/2" steel pipe. The steel pipe is readily available, in various lengths, at any local Home Center or Hardware store. With the new Sidewalk Spear™ tool kit, contractors

can now assemble low cost custom lengths of the tool to suit various sized obstacles. When properly assembled and used, the tool allows the user to install 1" water pipe or electrical conduit under sidewalks in just a few minutes.

The Sidewalk Spear™ accommodates 1" PVC pipe (sch. 40 and Class sizes) and electrical conduit.



IMPORTANT

Always notify the local One-Call System prior to excavating, plowing or boring. Always expose utilities near your work by a non-destructive method before excavating, plowing or boring.

EXTREME DUTY LIGHTING/EDGING AND ROOT CUTTING SPADE

Triple D's new Lighting/Edging Spade is a heavy duty "all steel" tool designed to help the landscape lighting contractor install low voltage wire in areas inaccessible by machine, i.e. shrub and flower beds.

This new Spade uses a 1/4" thick alloy steel, square-point blade with the handle set directly over the blade to provide leverage for edging and cutting into roots and surfaces. The top of the blade is turned over and flattened to provide an extra-wide step that is easier on your foot. For added strength, the handle/blade shank area is internally reinforced to make this tool one of the strongest in the industry.

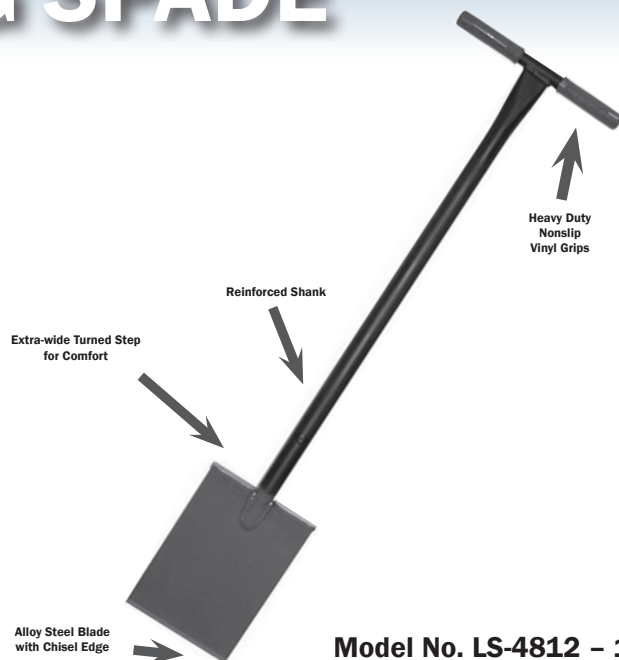

Model No. LS-4812 - 12"

ATTACHMENT HARDWARE

Load Rated Screw Pin Anchor Shackles



Quick-Links

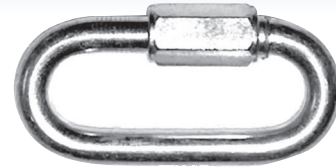

Load Rated Screw Pin Anchor Shackles

Part No.	Body Size	Pin Size	WLL (Lbs)
AS-312	5/16"	3/8"	1,500
AS-375	3/8"	7/16"	2,000
AS-438	7/16"	1/2"	3,000
AS-500	1/2"	5/8"	4,000
AS-625	5/8"	3/4"	6,500
AS-750	3/4"	7/8"	9,500
AS-875	7/8"	1"	13,000
AS-100	1"	1-1/8"	17,000

Quick Links

Part No.	Size
9N	5/16"
10N	3/8"
12N	1/2"

FASTENERS, MOUNTING SHIMS, & HITCH PINS

For all Except Pipe Piper



DITCH WITCH
1 3/8" x 6"
Part No. DW-6



DITCH WITCH
1 3/8" x 10"
Part No. DW-10

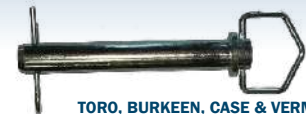

TORO, BURKEEN, CASE & VERMEER
1 1/8" x 6"
Part No. HP-6

Quick Links

Part No.	Description	Part No.	Description
S-10-250	Mounting Shim, 1/4" Thick - 2 Pcs.	SP-200	Spring Pin Set - 3/8" Dia. X 3" Lth.
S-10-312	Mounting Shim, 5/16" Thick - 2 Pcs.	SP-300	Spring Pin Set - 1/2" Dia. X 4" Lth.
S-10-375	Mounting Shim, 3/8" Thick - 2 Pcs.	DW30A-CB	Clamping Bar For Saber-Cut Blades
S-10-437	Mounting Shim, 7/16" Thick - 2 Pcs.	CS625175	Cap Screw, 5/8" X 1.75"
S-10-500	Mounting Shim, 1/2" Thick - 2 Pcs.	LW-625	Lock Washer, 5/8"
S-60-250	Mounting Plates For Case P-60 Plows	LN-625	Lock Nut, 5/8"
SCS-4	Socket Head Cap Screw, 1/2" X 4"	GP-250	Gate Pin - 3/8" X 2.50"
SCS-5	Socket Head Cap Screw, 5/8" X 5"	HP-6	Hitch Pin - 1.125" X 6.0" Fits Case/Toro, Burkeen & Vermeer
SP-75	Spring Pin Set - 1/4" Dia. X 1.5" Lth.	DW-6	Hitch Pin - 1.375" X 6.0" Fits Ditch Witch
SP-100	Spring Pin Set - 5/16" Dia. X 2" Lth.	DW-10	Hitch Pin - 1.375" X 10.0" Fits Ditch Witch
SP-125	Spring Pin Set - 3/8" Dia. X 2 1/2" Lth.	HPC-8	Hair Pin Clip For Hp-6, Dw-6 & Dw-10

HEAVY DUTY CARBIDE TIPPED BLADE BULLETS*

This heavy duty carbide tipped blade bullet is manufactured from solid steel bar stock on our modern CNC machinery for consistent quality. The solid one-piece bullet design uses a carbide tip for long service life and threaded receiver at the back for easy attachment of a lost-motion assembly.

These units may be purchased separately for field installation, or factory installed on new plowing blades.

May be used on 1/2" or thicker plowing blades.

A welded lug can be supplied at no additional cost.

* **Welding Required**

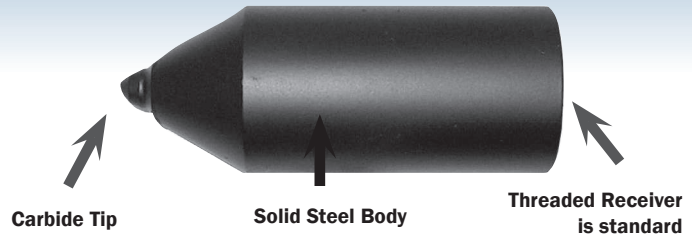

Part No.	Description
CB-200	2" dia.
CB-200X	2" dia. (exchange)
CB-250	2.5" dia.
CB-250X	2.5" dia. (exchange)
CB-300	3" dia.
CB-300X	3" dia. (exchange)
CB-350	3.5" dia.
CB-350X	3.5" dia. (exchange)

THE TURF HAMMER

Engineered for Performance

Converts Your Vibratory Plow Into An Efficient And Economical Tamper Within Seconds.*



TH-100 - fits Ditch Witch 255SX through 410SX



TH-200 - fits Toro/Case, Berkeen & Vermeer



TH-200D Turf Hammer Assembly, Dingo

Part No.	Description
TH-100L	"Turf hammer" ass'y. - Ditch witch 255 thru 410
TH-200	"Turf hammer" ass'y. - Case, burkeen & vermeer
TH-200D	"Turf hammer" ass'y. - Dingo
TH-100AL	Ram, tamper - ditch witch
TH-200A	Ram, tamper - case, burkeen & vermeer
TH-200DA	Ram, tamper - dingo
TH-30	Pin, king
TH-40	Foot assembly weldment
TH-55	Zerk grease fitting - 1/8" npt
TH-60	Washer, retaining
TH-70	Bolt, retaining - 3/8" x 3/4"
TH-80	Washer, lock - 3/8"

* Plows equipped with quick-disconnect pins

“RED HEAD”

Professional Series Installation Accessories

Meter Keys

MUELLER TYPE: 5/8 in. Structural Steel Rod Shaft with “Alloy Steel Head”

H.D. TYPE: Heavy Duty 3/4 in. Structural Steel Rod Shaft with “Alloy Steel Head”

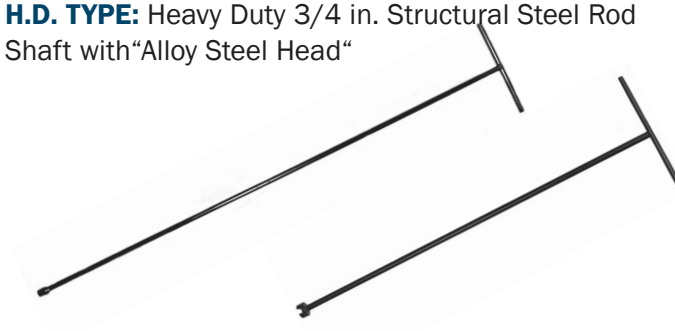

PROFESSIONAL METER KEYS			
Part No.	O/A Length	Head Width	Groove Opening
MU-60	5'	1"	7/16"
MU-72	6'	1"	7/16"
MK-60	5'	1.5"	3/4"
MK72	6'	1.5"	3/4"

Operating Wrench

1 in. Square Tube Construction

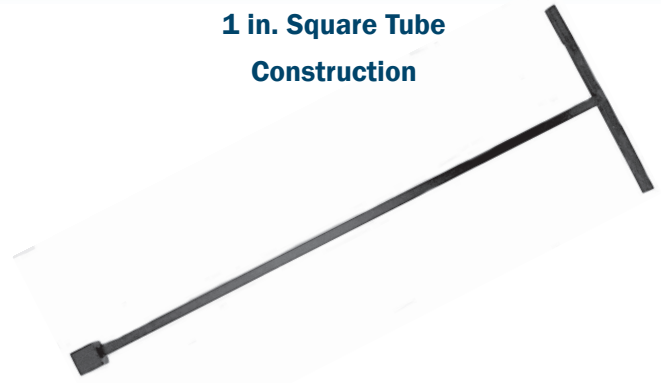

PROFESSIONAL OPERATING WRENCHES		
Part No.	O/A Length	Head Width
OW-48	4'	2"
OW-60	5'	2"

H.D. Steel Dirt Tampers



Part No.	Plate Size	Handle Length
T-88-48	8x8	48"
T-88-60	8x8	60"
T-1010-48	10x10	48"
T-1010-60	10x10	60"
T-410-60	4x10	60"

Curb/Service Keys

Commercial Series

For Standard Valves

The curb/service valve keys listed below are manufactured from 1/2" solid round A-36 steel and 1/4" x 1" formed steel driver heads for an excellent performance to cost ratio, and they cost 55% less than our "Red Head" professional series of curb keys.

10" HANDLE - SOLID ROUND STEEL SHANK			
Part No.	OAL	HEAD SIZE	PKG. QTY.
CK-28	28"	1"x1.625"	10
CK-60	60"	1"x1.625"	10

* Other lengths are available on special order.

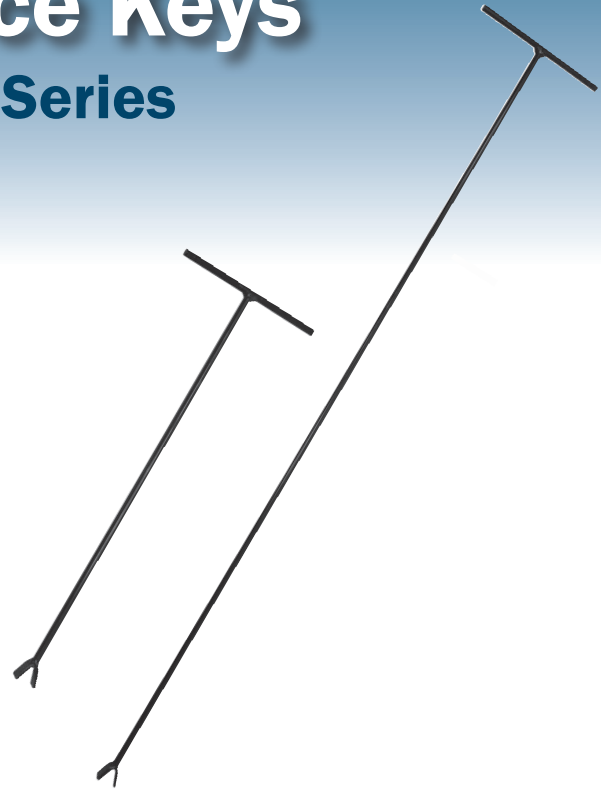

Wire Rope Pulling Slings

Pulling Slings, manufactured in house by Triple D, allow multiple pulls of cable, pipe or duct at one time by using staggered attachment. The staggered arrangement insures that individual connections do not interfere with each other.

These high quality pulling slings are manufactured from extra flexible, 7x19, galvanized aircraft cable for strength and durability. Individual Legs are replaceable. Working Leg Loads and Total Work Loads are based on equal horizontal loads on all cables and a safety factor of 3:1.

Not For Overhead Use!



Part No.	Description	Part No.	Description
WRS-202	1/4" Dia. Cable, 2 Legs, Total Work Ld. 4,000 Lbs.	WRS-402	1/2" Dia. Cable, 2 Legs, Total Work Ld. 13,000 Lbs.
WRS-203	1/4" Dia. Cable, 3 Legs, Total Work Ld. 6,500 Lbs.	WRS-403	1/2" Dia. Cable, 3 Legs, Total Work Ld. 13,000 Lbs.
WRS-204	1/4" Dia. Cable, 4 Legs, Total Work Ld. 6,500 Lbs.	WRS-404	1/2" Dia. Cable, 4 Legs, Total Work Ld. 17,000 Lbs.
WRS-205	1/4" Dia. Cable, 5 Legs, Total Work Ld. 6,500 Lbs.	WRS-406	1/2" Dia. Cable, 6 Legs, Total Work Ld. 17,000 Lbs.
WRS-206	1/4" Dia. Cable, 6 Legs, Total Work Ld. 6,500 Lbs.	DS-500	Sling Shackle - 1/2". 4,000 Lb. W/L
WRS-302	3/8" Dia. Cable, 2 Legs, Total Work Ld. 9,500 Lbs.	DS-625	Sling Shackle - 5/8". 6,500 Lb. W/L
WRS-303	3/8" Dia. Cable, 3 Legs, Total Work Ld. 9,500 Lbs.	DS-750	Sling Shackle - 3/4". 9,500 Lb. W/L
WRS-304	3/8" Dia. Cable, 4 Legs, Total Work Ld. 13,000 Lbs.	DS-875	Sling Shackle - 7/8". 11,000 Lb. W/L
WRS-305	3/8" Dia. Cable, 5 Legs, Total Work Ld. 13,000 Lbs.	DS-100	Sling Shackle - 1.0". 17,000 Lb. W/L
WRS-306	3/8" Dia. Cable, 6 Legs, Total Work Ld. 13,000 Lbs.		

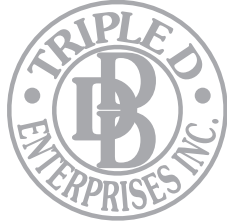

TRIPLE D ENTERPRISES

135 Eayrestown Road
Southampton, New Jersey 08088
TEL: (609) 859-3000 • FAX: (609) 859-4408
www.triplednj.com

WARRANTY

Triple D Enterprises, Inc. manufactured products (except as noted) are guaranteed against any defect in material or workmanship for a period of thirty (30) days from date of purchase when owned by original purchaser or first user, and maintained and operated under normal conditions. Any products not manufactured by Triple D Enterprises, Inc. are warranted only to the extent of the original manufacturer's warranty. Parts found to be defective in material or workmanship under this guaranty shall be repaired or replaced without charge, F.O.B. original point of shipment, provided prompt written notice of the defect is given and compliance with the terms of the guaranty is established. **THE FOREGOING SHALL BE PURCHASER'S SOLE AND EXCLUSIVE REMEDY FOR DEFECTS.** Underground tools are **CONSUMABLE ITEMS!** Therefore, wear caused by abrasion and normal use is not warranted. This warranty shall be void if repairs or alterations are made. No person, agent, representative, salesman, dealer or distributor has any authority to change or extend the warranty expressed herein nor to obligate Triple D Enterprises, Inc. by any terms, stipulations or conditions not herein expressed. **THE ABOVE WARRANTIES ARE IN LIEU OF ALL OTHER WARRANTIES EXPRESSED OR IMPLIED, INCLUDING IMPLIED WARRANTY OF MERCHANTABILITY OR FITNESS FOR A PARTICULAR PURPOSE.**

WARRANTY DISCLAIMER

The following products are not warranted:

1. 1/4" and 3/8" thick plowing blades.
2. All horizontal boring equipment.

LIMITATION OF LIABILITY

Purchaser agrees and acknowledges that in no event shall Triple D Enterprises, Inc. be liable to Purchaser or to any third party for ordinary, special, consequential or incidental damages or losses or for any expenses or damages incurred by Purchaser or any third party attributable to any item sold by Triple D Enterprises, Inc

IMPORTANT

TRIPLE D ENTERPRISES, INC. reserves the right to make changes in engineering, design, materials and specifications: add improvements: or discontinue manufacture at any time without notice and without incurring any obligation related to such changes.

IMPORTANT

ALWAYS NOTIFY THE LOCAL ONE-CALL SYSTEM PRIOR TO EXCAVATING, PLOWING OR BORING. ALWAYS EXPOSE UTILITIES NEAR YOUR WORK BY A NON-DESTRUCTIVE METHOD BEFORE EXCAVATING, PLOWING OR BORING.

NOTE: All manufacturer's names, symbols, and descriptions are used for reference purposes only, and none of the products listed are the products of these manufacturers.



TRIPLE D ENTERPRISES

Plowing Systems, Horizontal Compaction Boring
Tools & Accessories

135 Eayrestown Road, Southampton, New Jersey 08088
TEL: (609) 859-3000 • FAX:(609) 859-4408

www.triplednj.com